



CATÁLOGO TARIFA
GENERAL. E.

2026

PRESENTACIÓN

03

EQUIPAMIENTO WC

CISTERNAS EMPOTRADAS	13
CISTERNAS DE CRISTAL	25
ESTRUCTURAS BIDET	29
DESCARGADORES	31
REPUESTOS DESCARGADORES	45
MECANISMOS COMPLETOS	49
GRIFOS ALIMENTACIÓN	53
CONJUNTOS HIGIÉNICOS DUCHA-BIDET	65
CISTERNAS COMPLETAS: SEMIALTAS, BAJAS Y TANQUE ALTO	75
EQUIPAMIENTO TANQUE ALTO	81
ASIENTOS DE INODORO	83
ASIENTOS DE DUCHA	89
MANGUITOS DE INODORO	91
RECAMBIOS	97

SIFONES Y VÁLVULAS

CLICK-CLACK Y SIFONES	113
CLICK-CLACK Y SIFONES ACABADOS ESPECIALES	121
RECAMBIOS CLICK-CLACK Y SIFONES	127
LAVABO-BIDET	129
FREGADERO	133
DUCHA	141
BAÑERA	147
URINARIO	151
TUBOS FLEXIBLES	153
RECAMBIOS	157

PRESENTACIÓN DE PRODUCTO

167

CONDICIONES GENERALES

173

ÍNDICE POR CÓDIGO

175

La empresa

A lo largo de los años en H & H Idrospania Technic, S.L. nos hemos consolidado como una empresa líder en el sector de equipamiento de fontanería. La alta calidad de nuestros productos, el inmejorable servicio y la profesionalidad del equipo humano que hay detrás de todo el proceso, tienen como resultado el reconocimiento de la empresa como una marca de prestigio que cuenta con la certificación de calidad ISO 9001:2015.

La implicación absoluta de todo el equipo de H & H Idrospania Technic, S.L. ha sido clave para llevar a la empresa al más alto nivel posible. Nos hemos adaptado rápidamente a las exigencias de los mercados tanto nacionales como internacionales, para ofrecer un producto fiable, de calidad y que protege el medio ambiente, utilizando materias primas de primera calidad y maquinaria de última tecnología.

En H.&H. Idrospania Technic S.L. estamos concienciados con la importancia de ser respetuosos con el medio ambiente, por ello la política medioambiental de la empresa va dirigida al consumo eficiente de agua. Contamos con una amplia gama de productos que ofrecen la posibilidad de interrumpir la descarga, o bien elegir una descarga de 3 o 6 litros dejando el control del consumo y el ahorro en manos del consumidor final. Para nosotros, la confianza y satisfacción de los clientes es el resultado de proporcionar un trabajo ágil, profesional y personalizado, que en conjunto con nuestros productos de fácil instalación y larga durabilidad, nos ha llevado a ser un referente en el sector.







MATERIA PRIMA



PLANTA DE INYECCIÓN

Fabricación

En nuestras instalaciones disponemos de la última tecnología de fabricación de piezas plásticas. Contamos con maquinaria de inyección de plástico moderna, y todos nuestros productos se fabrican mediante una materia prima de alta calidad.



PIEZAS INYECTADAS

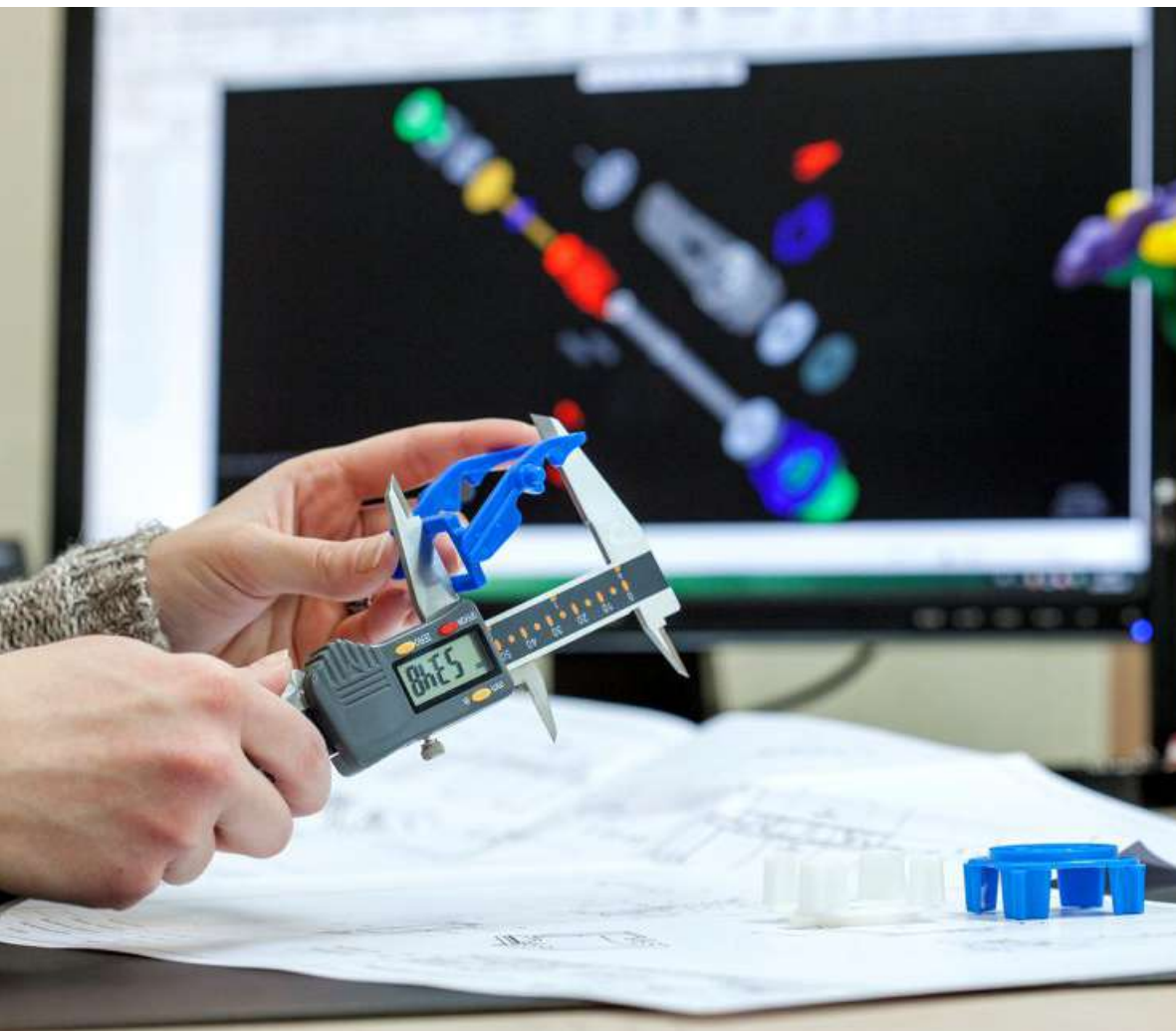

I+D+i



LABORATORIO

Calidad

Nuestro compromiso con la calidad se ve reflejado en cada uno de los procesos de producción, controlando cada etapa durante la fabricación de nuestros productos desde la llegada de las materias primas hasta el embalaje final.



ESTACIÓN DE COMPROBADO GRIFOS SERVO

A través de una apuesta fuerte y gran inversión, tanto en recursos humanos como en equipamiento de control, garantizamos un producto de calidad, duradero y que cumpla con las expectativas de nuestros clientes.

Consecuencia de esta búsqueda constante de la mejora continua, no solo en los productos sino también en la gestión de la calidad, son los diferentes certificados de calidad como el ISO 9001:2015.



LÍNEA DE MONTAJE AUTOMÁTICO



EMBOLSADO FLOW-PACK

Logística

En nuestro almacén de expediciones disponemos de un amplio stock para dar una respuesta rápida y un servicio satisfactorio a nuestros clientes, reduciendo al mínimo los tiempos de entrega.



ALMACÉN

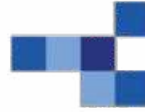

Certificado del Sistema de Gestión de la Calidad



ER-0506/2017

AENOR certifica que la organización

H. & H. IDROSPANIA TECHNIC, S.L.

dispone de un sistema de gestión de la calidad conforme con la Norma ISO 9001:2015

para las actividades: El diseño, la producción y la venta de productos hidrosanitarios de plástico por inyección y soplado.

que se realizan en: P.E. CARABONA, AV DE L'ARGENT, PARCELA M-3, 12530, BURRIANA (CASTELLÓN)

Primera Emisión: 2017-09-28
Última Emisión: 2024-09-26

Último Ciclo: 2026-09-26

Rafael GARCÍA MEIRO
CEO



AENOR INTERNACIONAL S.A.U.
Génova, 6. 28004 Madrid, España
TEL: (+34) 91 452 60 00 - www.aenor.com



Building
trust
together.

Certificate

AENOR has issued an IQNET recognized certificate that the organization:

H. & H. IDROSPANIA TECHNIC, S.L.

PARQUE EMPRESARIAL CARABONA, AV DE L'ARGENT, PARCELA M-3,
12530- BURRIANA
(CASTELLÓ / CASTELLÓN)

has implemented and maintains a/an
Quality Management System

for the following scope:

The design, production and sale by plastic injection of hydrosanitary products.

which fulfils the requirements of the following standard

ISO 9001:2015

First issued on **2017-09-28** Last issued **2023-09-28** Validity date **2026-09-28**

Registration Number: **ES-0506/2017**

Alex Stoichitoiu
President of IQNET

Rafael GARCÍA MEIRO
CEO

AENOR
Confía

This attestation is directly linked to the IQNET Member's original certificate and shall not be used as a stand-alone document.

IQNET Members*:
AENOR Spain AFNOR Certification France APCER Portugal CCC Cyprus CISQ Italy CQC China CQM China CQS Czech Republic
Cro Cert Croatia DQS Holding GmbH Germany EAGLE Certification Group USA FCAV Brazil FONDONORMA Venezuela ICONTEC
Colombia ICS Bosnia and Herzegovina Inspecta Serfiteintli Oy Finland INTECO Costa Rica IRAM Argentina JOA Japan KPO Korea
LSQA Uruguay MIRTEC Greece MSZT Hungary Nemko AS Norway NSAI Ireland NYCE-SIGE México PCBC Poland Quality Austria
Austria SII Israel SIG Slovenia SIRIM QAS International Malaysia SGS Switzerland SRAC Romania TSE Türkiye YUOS Serbia

*The list of IQNET Members is valid at the time of issue of this certificate. Updated information is available under www.iqnet-certification.com

Référentiel de certification / Certification reference system
NF076 - Composants sanitaires / Sanitary components

N° **236-U1-24/1**



AFNOR Certification accorde le droit d'usage de la marque NF à la société :

AFNOR Certification grants the right to use the NF Mark to the company :

Nom du titulaire :
Holder name :

H&H IDROSPANIA TECHNIC SL
 AVDA L ARGENT - PARCELA M3 PARQUE EMPRESARIAL CARABONA
 12530 BURRIANA
 Espagne

Pour les produits listés ci-après, certifiés conformes aux exigences du référentiel de certification, par le CSTB organisme mandaté.

For the products listed below, certified conform to the certification reference system requirements by the CSTB mandated certification body;

Sites
Sites

Espagne - 12530 BURRIANA - IDRS01



La validité de ce certificat et la liste des produits certifiés sont vérifiables sur le site Internet ou en flashant le QR-code ci-contre :

The validity of this certificate and the certified product list can both be checked on the website or by flashing the QR-Code:
<https://evaluation.cstb.fr>

Décision de Certification / Certification decision N° **236-U1-24/1** du **15/02/2024**
 Cette décision se substitue à la décision / This decision replaces the decision N° **236-U1-23/2** du **18/10/2023**
 Décision d'admission initiale / Admission decision N° **236-U1-13/1** du **13/02/2013**

 Président du CSTB
 Etienne CREPON

Fait à : **Marne-la-Vallée, France.**
Done at
 Date: **29/02/2024**
Date

En vertu de la présente décision notifiée par le CSTB organisme mandaté, AFNOR Certification accorde le droit d'usage de la Marque NF à la société qui en est titulaire pour les produits visés par ce certificat, dans les conditions définies par les règles générales de la Marque NF et par les règles de certification NF, pour autant que les contrôles réguliers de la fabrication et les vérifications par tierce partie soient satisfaisants.

On the strength of the present decision notified by CSTB mandated certification body, AFNOR Certification grants the right to use the NF Mark to the licence holder for the products mentioned in this certificate, within the frame of the general rules of the NF Mark and of the NF certification rules as far as the regular checking and third party verifications of the production are satisfactory.



CENTRE SCIENTIFIQUE ET TECHNIQUE DU BATIMENT ORGANISME CERTIFICATEUR

84 avenue Jean Jaurès ☐ Champs-sur-Marne ☐ 77447 Marne-la-Vallée Cedex 2
 Tél. (33) 01 64 68 82 82 ☐ Fax (33) 01 64 68 89 94 ☐ www.cstb.fr
 MARNE-LA-VALLÉE / PARIS / GRENOBLE / NANTES / SOPHIA-ANTIPOLIS



NORMATIVA NF

PARA MECANISMOS DE DESCARGA Y GRIFOS FLOTADOR NF076

MECANISMOS DE DESCARGA

- **CAUDAL DE DESCARGA:** ≥ 2,5 L / s en descarga total y 2,2 L/s en parcial.
- **CAUDAL MÍNIMO DE DESBORDAMIENTO:** en caso de llenado continuo del tanque, el tubo rebosadero garantiza la total evacuación del agua sin desbordamiento de la cisterna.
- **RESISTENCIA:** 200.000 ciclos mínimo.
- **FUERZA DE ACCIONAMIENTO:** <2 kg.
- **ESTANQUEIDAD** de la junta de cierre.

GRIFOS FLOTADOR

- **CONFORT ACÚSTICO** (clase 1: menos de 20 decibelios, clase 2: <20 a 30 decibelios).
- **VELOCIDAD DE LLENADO:** 3 L / min a 0,5 bar.
El caudal mínimo a 3 bares es de 12 L / min.
- **Sistema anti-golpes** al cierre.
- **PRESIÓN:** opera de 0,5 a 10 bares.
- **ANTI-RETORNO:** garantiza que no se devuelva el agua del tanque al circuito de agua potable de la vivienda.
- **RESISTENCIA:** 200.000 ciclos mínimo.

IAPMO RESEARCH AND TESTING, INC.

5001 E. Philadelphia Street, Ontario, CA 91761 • Phone (909) 472-4100 • Fax (909) 472-4244 • www.iapmort.org



CERTIFICATE OF LISTING



IAPMO Research and Testing, Inc. is a product certification body in which its product certification system includes inspection and testing of samples taken from the supplier's stock or from the market or a combination of both to verify compliance to the requirements of applicable codes and standards. This activity is coupled with periodic surveillance of the supplier's factory and/or warehouses as well as the assessment of the supplier's Quality Assurance System. This listing is subject to the conditions set forth in the characteristics below and is not to be construed as any recommendation, assurance or guarantee by IAPMO Research and Testing, Inc. of the product acceptance by Authorities Having Jurisdiction.

Issued To:

H&H IDROSPANIA TECHNIC S.L

AVDA L ARGENT 16, PARCELA M3 P.E. CARABONA BURRIANA 12530, CASTELLON, SPAIN

Product:

Fill Valves (Anti-Siphon)

Products are in compliance with the following code(s):

Uniform Plumbing Code (UPC®)
National Plumbing Code of Canada

Products are certified to the following standard(s)

ASSE 1002-2020/ASME A112.1002-2020/CSA B125.12-20

File Number: 17091

Effective Date: March 2025

Void After: March 2030*

Chairman, Product Certification Committee



Chief Technical Service Officer

*This certificate is not evidence of current listing. To verify listing status, visit the IAPMO R&T Product Listing Directory at pld.iapmo.org

This listing period is based upon the last date of the month indicated on the Effective Date and Void After Date shown above. Any change in material, manufacturing process, marking or design without having first obtained the approval of the Product Certification Committee, or any evidence of non-compliance with applicable codes and standards or of inferior workmanship, may be deemed sufficient cause for revocation of this listing. Production of or reference to this form for advertising purposes may be made only by specific written permission of IAPMO Research and Testing, Inc. Any alteration of this certificate could be grounds for revocation of the listing. This document shall be reproduced in its entirety.

IAPMO RESEARCH AND TESTING, INC.

5001 E. Philadelphia Street, Ontario, CA 91761 • Phone (909) 472-4100 • Fax (909) 472-4244 • www.iapmort.org



CERTIFICATE OF LISTING



IAPMO Research and Testing, Inc. is a product certification body in which its product certification system includes inspection and testing of samples taken from the supplier's stock or from the market or a combination of both to verify compliance to the requirements of applicable codes and standards. This activity is coupled with periodic surveillance of the supplier's factory and/or warehouses as well as the assessment of the supplier's Quality Assurance System. This listing is subject to the conditions set forth in the characteristics below and is not to be construed as any recommendation, assurance or guarantee by IAPMO Research and Testing, Inc. of the product acceptance by Authorities Having Jurisdiction.

Issued To:

H&H IDROSPANIA TECHNIC S.L

AVDA L ARGENT 16, PARCELA M3 P.E. CARABONA BURRIANA 12530, CASTELLON, SPAIN

Product:

Flush Valves with Dual Flush Device for Water Closets

Products are in compliance with the following code(s):

Uniform Plumbing Code (UPC®)
National Plumbing Code of Canada

Products are certified to the following standard(s)

IAPMO PS 50-2019 and ASME A112.19.5-2022/CSA B45.15-22

File Number: 17090

Effective Date: March 2025

Revised Date: April 7, 2025

Void After: March 2030*

Chairman, Product Certification Committee



Chief Technical Service Officer

*This certificate is not evidence of current listing. To verify listing status, visit the IAPMO R&T Product Listing Directory at pld.iapmo.org

This listing period is based upon the last date of the month indicated on the Effective Date and Void After Date shown above. Any change in material, manufacturing process, marking or design without having first obtained the approval of the Product Certification Committee, or any evidence of non-compliance with applicable codes and standards or of inferior workmanship, may be deemed sufficient cause for revocation of this listing. Production of or reference to this form for advertising purposes may be made only by specific written permission of IAPMO Research and Testing, Inc. Any alteration of this certificate could be grounds for revocation of the listing. This document shall be reproduced in its entirety.



CISTERNAS EMPOTRADAS

Mod. Menorca



PRODUCTO
NUEVO

PRODUCTO
NUEVO

Cod.		€
40220	Cisterna empotrada mecanismo cable de doble descarga con estructura metálica, para inodoros suspendidos	283,50
30817	Placa insonorización WC y bidet (420x420 mm). Blanco	6,45
30817.NE	Placa insonorización WC y bidet (420x420 mm). Antracita	6,45



- Doble descarga
- Testado x200.000
- Espesor 9cm
- Llenado silencioso
- Resistencia
- Cisterna plástico fabricada en una sola pieza

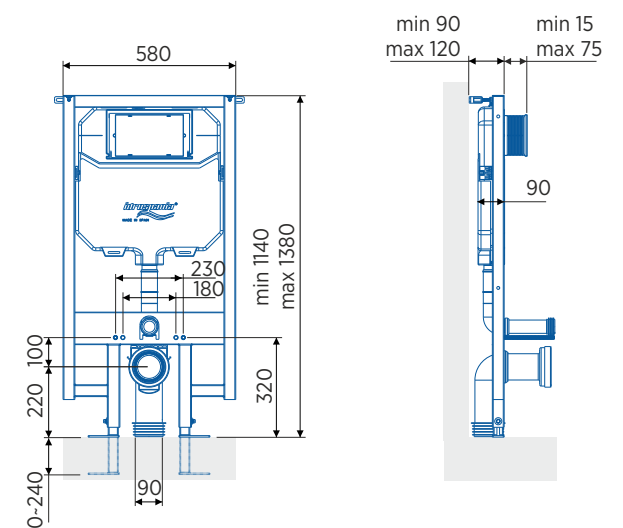

MADE IN SPAIN

CE CUMPLE NORMATIVA UNE-EN 14055 EN 14124

AENOR FLEXIBLES

CISTERNAS EMPOTRADAS

EQUIPAMIENTO WC

Mod. Tabarca

CONSULTA VÍDEO
INSTALACIÓN



Cod.		€
40230	Cisterna empotrada mecanismo cable de doble descarga con estructura metálica, para inodoros suspendidos	247,85

PRODUCTO NUEVO

30817	Placa insonorización WC y bidet (420x420 mm). Blanco	6,45
--------------	--	------

PRODUCTO NUEVO

30817.NE	Placa insonorización WC y bidet (420x420 mm). Antracita	6,45
-----------------	---	------

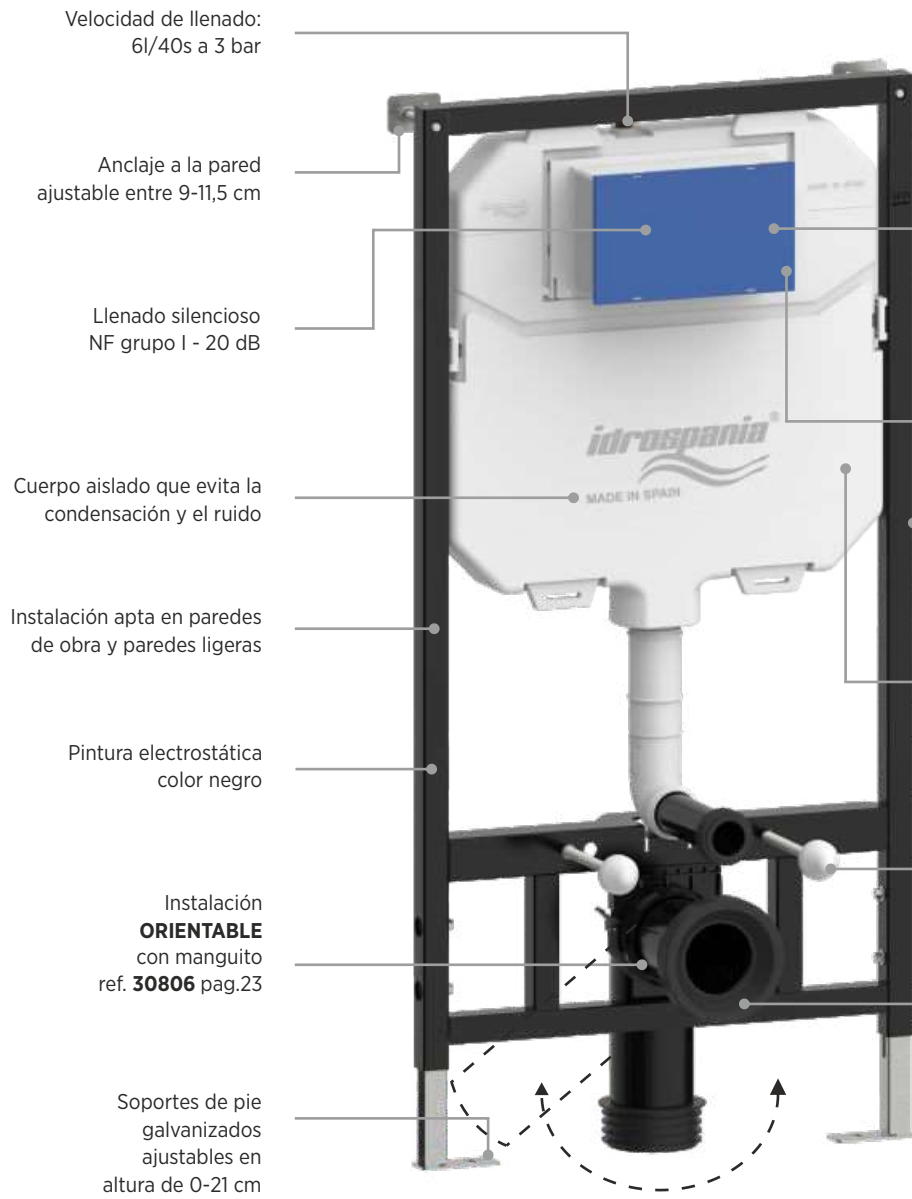

- Tapa registro protección anti-suciedad
- Descarga doble pulsador regulable a 3/6 l
- Estructura fabricada en acero de altas prestaciones
- Presiones alimentación de agua :0,5 - 16 bar
- Soportes de inodoro ajustable a 18 o 23 cm
- Instalación para inodoros suspendidos

- Doble descarga
- Testado x200.000
- Espesor 9cm
- Llenado silencioso
- Resistencia
- Cisterna plástico fabricada en una sola pieza

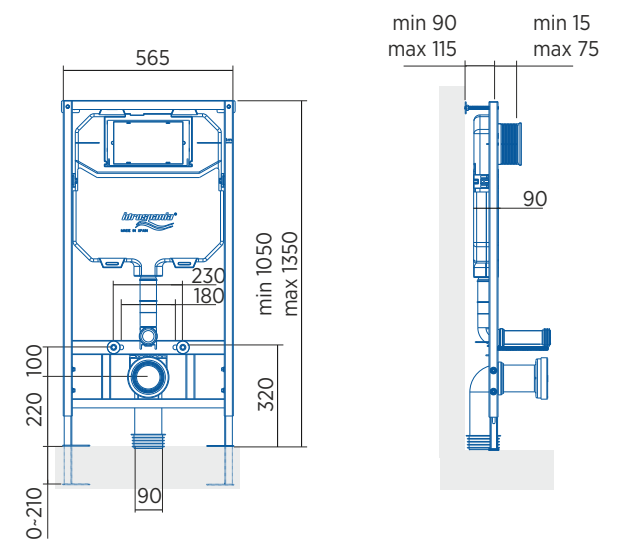

MADE IN SPAIN

CUMPLE NORMATIVA UNE-EN 14055 EN 14124

AENOR FLEXIBLES

Mod. Málaga

CONSULTA VÍDEO
INSTALACIÓN

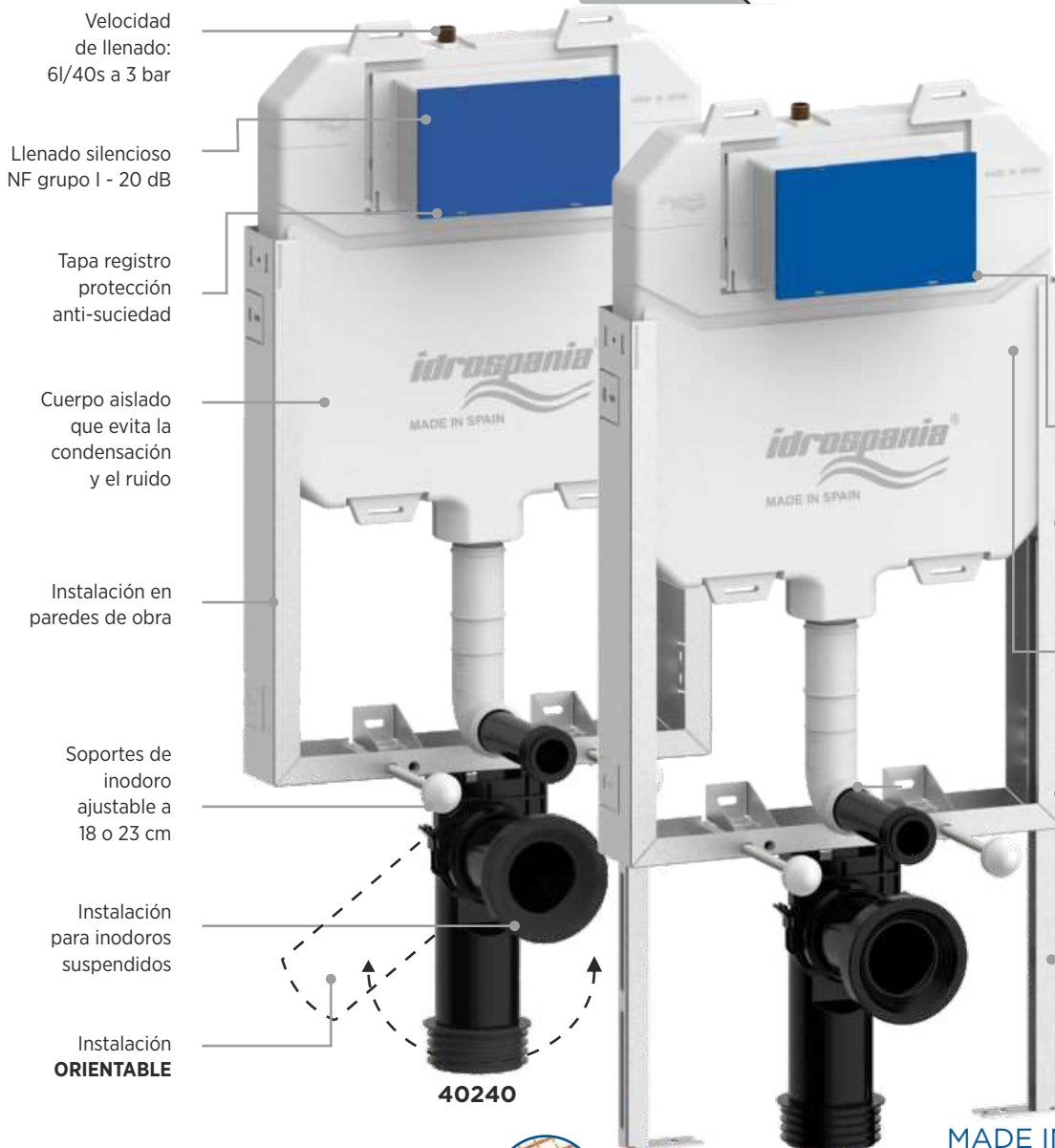

INCLUIDA
MALLA DE
ENLUCIDO

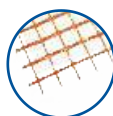

MADE IN SPAIN



CUMPLE
NORMATIVA
UNE-EN 14055
EN 14124



PRODUCTO NUEVO 30817

PRODUCTO NUEVO 30817.NE

Cod.	€
40240	192,70
40245	215,25
30817	6,45
30817.NE	6,45

Doble descarga

Testado x200.000

Resistencia

Llenado silencioso

Espesor 9cm

Cisterna plástico fabricada en una sola pieza

908

420

170

100

220

580

502

230

180

818

320

90

90

min 15
max 75

Mod. Marbella

Cod.		€
40320	Cisterna empotrada mecanismo cable de doble descarga, para inodoros a suelo	153,35

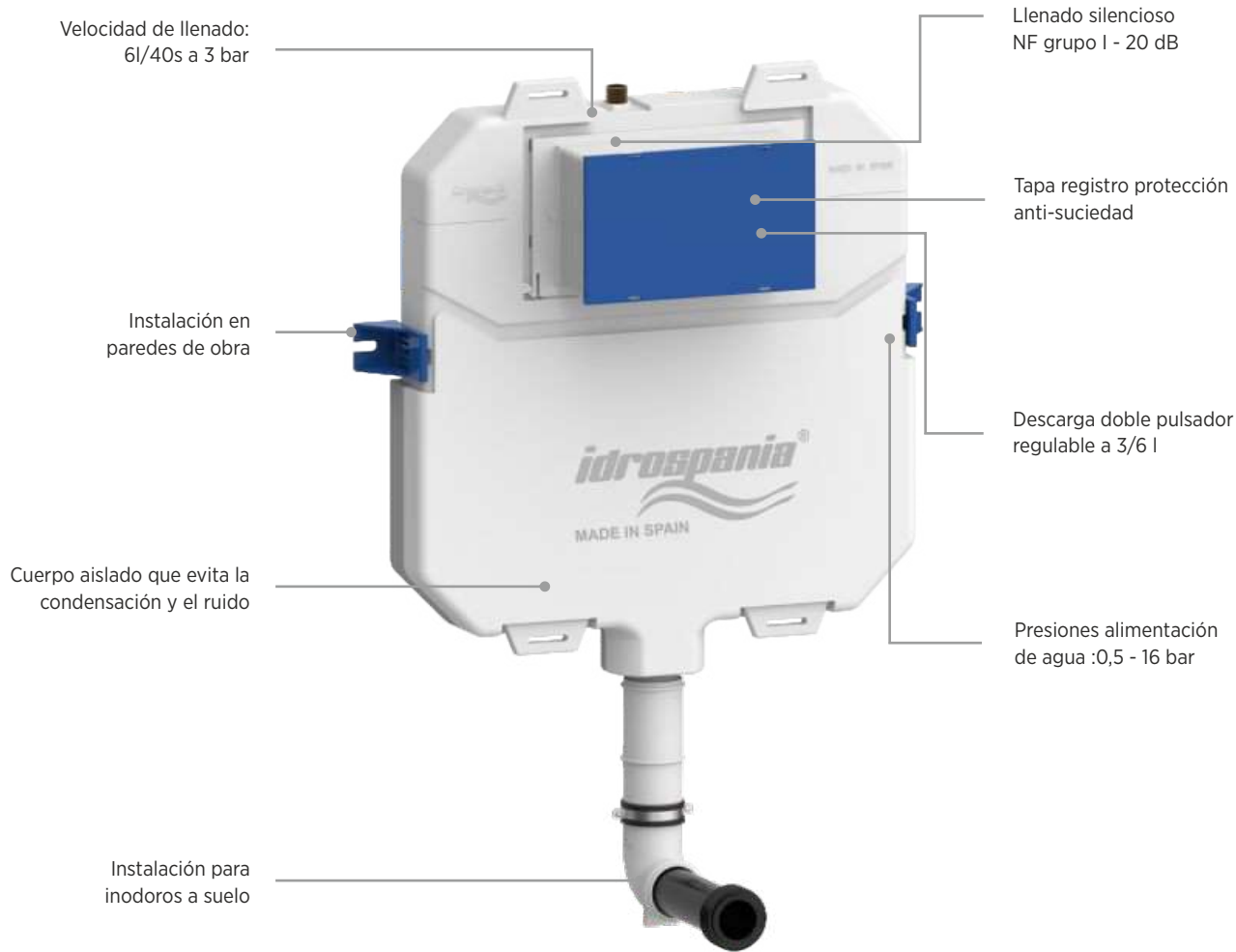

Doble descarga



Testado x200.000



Espesor 8,5cm



Llenado silencioso



Cisterna plástico fabricada en una sola pieza



Para inodoro a suelo

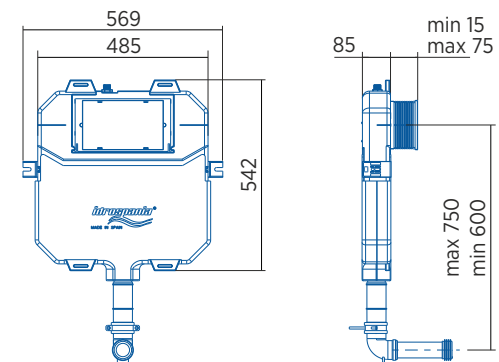

INCLUIDA MALLA DE ENLUCIDO

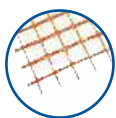

MADE IN SPAIN



Mod. Andrea

PULSADORES EQUIPAMIENTO WC Placa de accionamiento doble pulsador

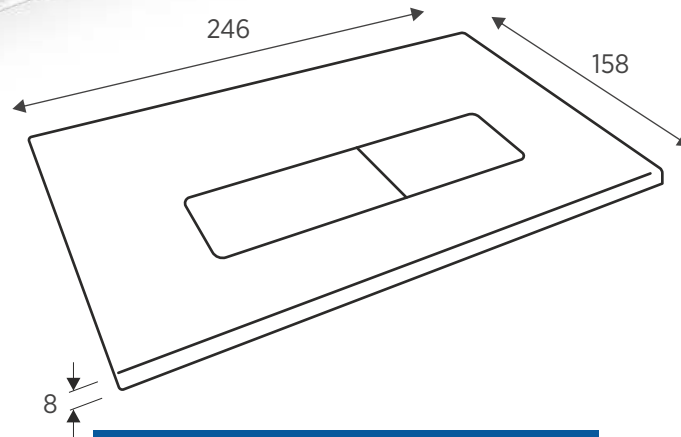
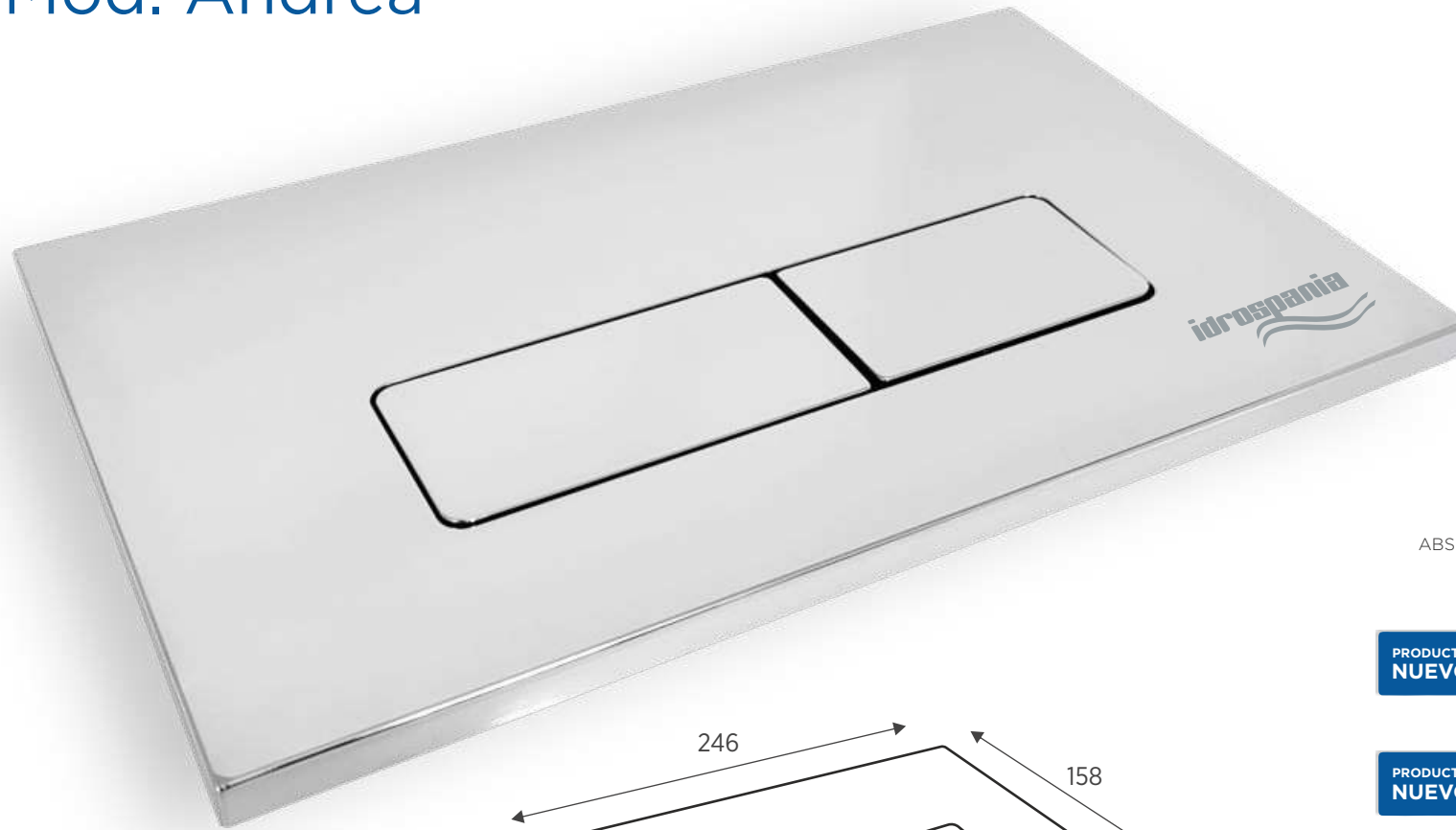

OPCIÓN .10 PULSADORES NEUTROS ANÓNIMOS SIN GRABAR

303500
ABS Blanco brillo
28,60€



303501
ABS Cromo brillo
39,60€



303506
ABS Blanco mate
37,00€



303502
ABS Cromo mate
44,00€



303504
ABS Negro mate
37,00€



303505
ABS Negro mate/ Cromo mate
39,60€



PRODUCTO NUEVO
303507.10
ABS Cobre cepillado
44,90€

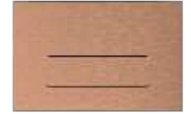

PRODUCTO NUEVO
303508.10
ABS Oro cepillado
44,90€



PRODUCTO NUEVO
303511.10
ABS Champagne
44,90€



ACABADO PVD **PRODUCTO NUEVO**
303512.10
ABS Black gun metal
53,45€



PRODUCTO NUEVO
303513
ABS Gris mate
53,45€



PULSADORES
EQUIPAMIENTO WC

Placa de accionamiento
doble pulsador

Mod. Belén

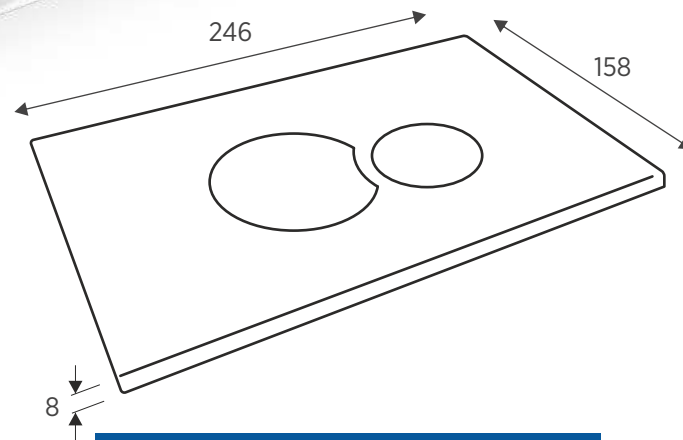
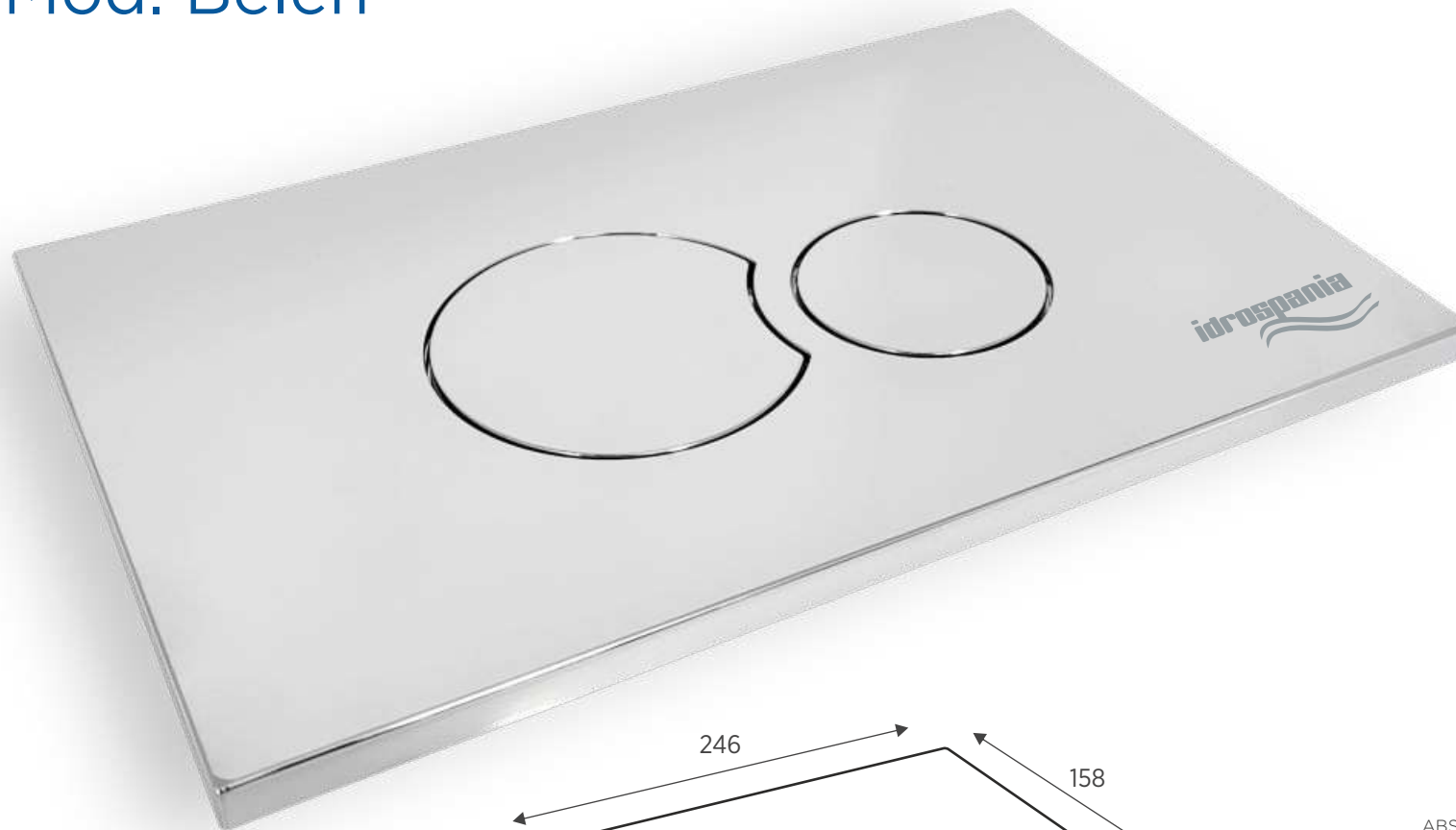

OPCIÓN .10 PULSADORES NEUTROS ANÓNIMOS
SIN GRABAR

303600
ABS Blanco brillo
28,60€



303601
ABS Cromo brillo
39,60€



303606
ABS Blanco mate
37,00€



303602
ABS Cromo mate
44,00€



303604
ABS Negro mate
37,00€



303605
ABS Negro mate/ Cromo mate
39,10€



Mod. Noelia

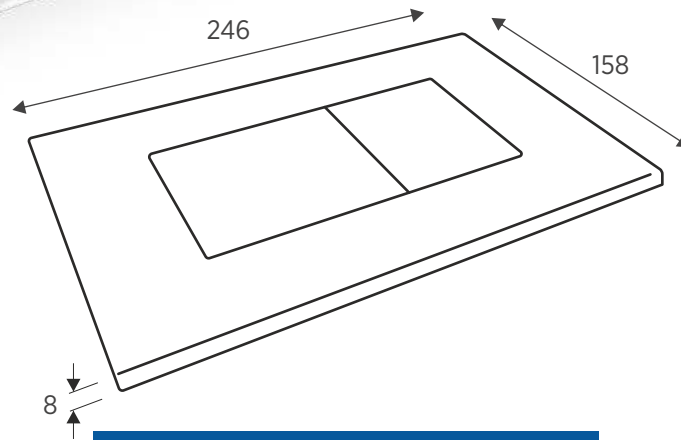
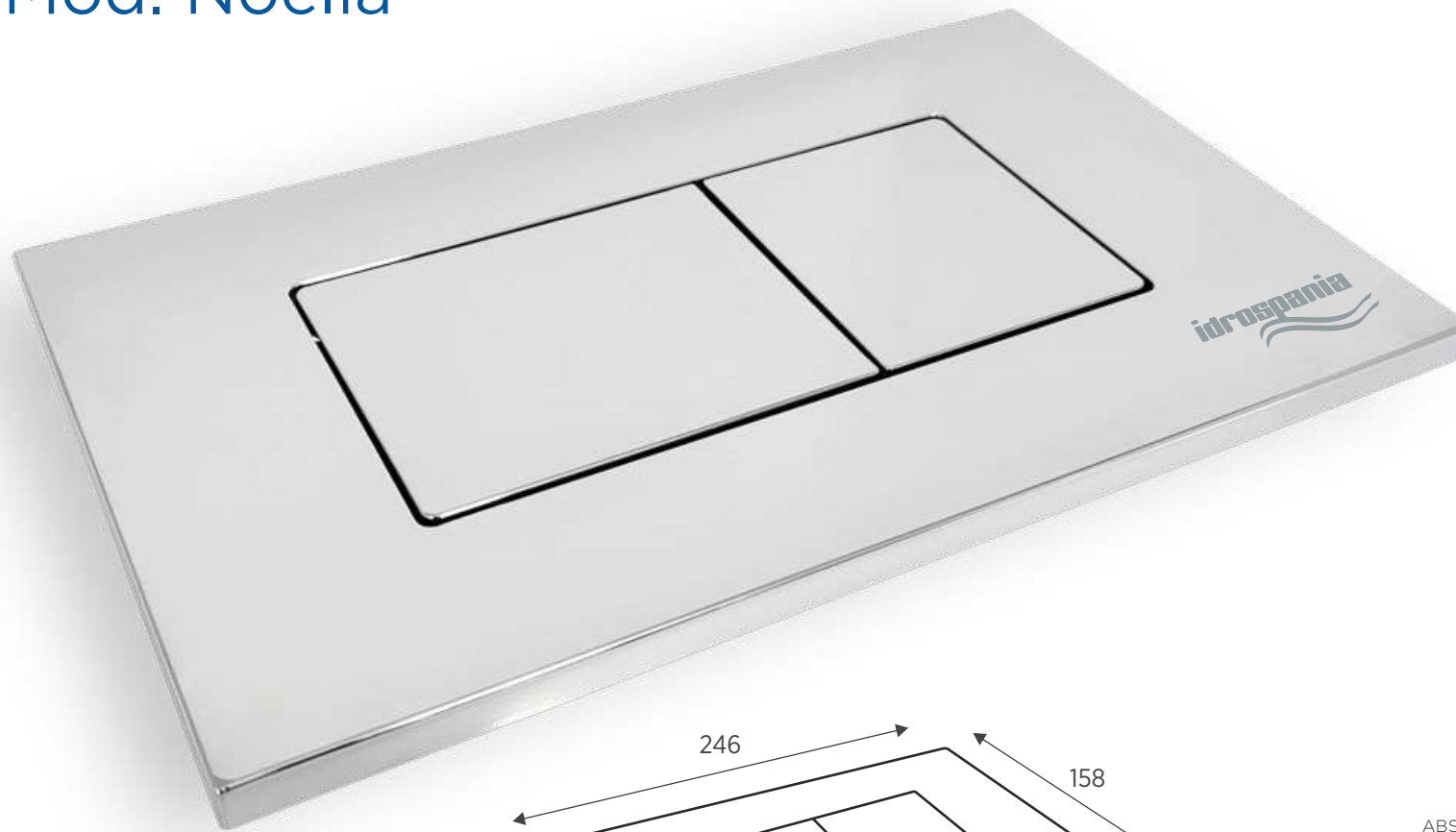

OPCIÓN .10 PULSADORES NEUTROS ANÓNIMOS
SIN GRABAR

303700
ABS Blanco brillo
28,60€



303701
ABS Cromo brillo
39,60€



303706
ABS Blanco mate
37,00€



303702
ABS Cromo mate
44,00€

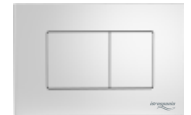

303704
ABS Negro mate
37,00€



303705
ABS Negro mate/ Cromo mate
39,60€



PULSADORES
EQUIPAMIENTO WC

Placa de accionamiento
doble pulsador

Mod. Inox
Antivandálico



PRODUCTO
NUEVO

303801
INOX cepillado
77,10€

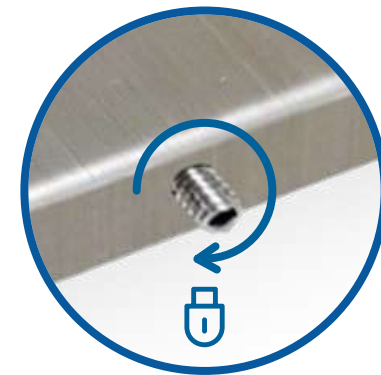
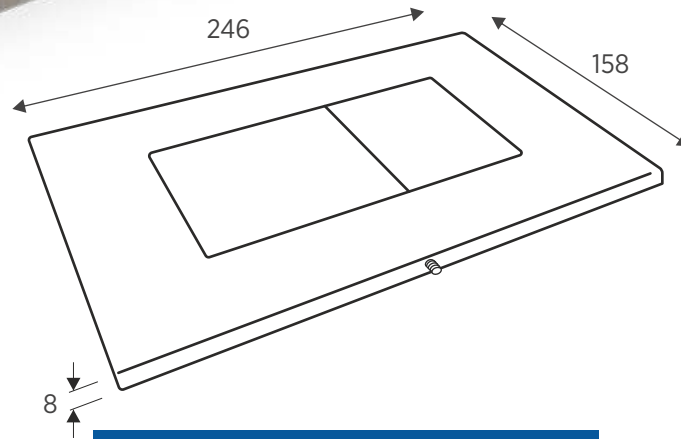

OPCIÓN .10 PULSADORES NEUTROS ANÓNIMOS
SIN GRABAR

Mod. Magnético
SISTEMA PATENTADO





PRODUCTO
NUEVO

Mod. Magnético NOELIA

303701.MAG
ABS Cromo brillo
50,65€

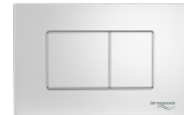

303702.MAG
ABS Cromo mate
55,05€



303706.MAG
ABS Blanco mate
48,00€



303704.MAG
ABS Negro mate
48,00€



PRODUCTO
NUEVO

Mod. Magnético ANDREA

303502.MAG
ABS Cromo mate
55,05€



303506.MAG
ABS Blanco mate
48,00€



303504.MAG
ABS Negro mate
48,00€

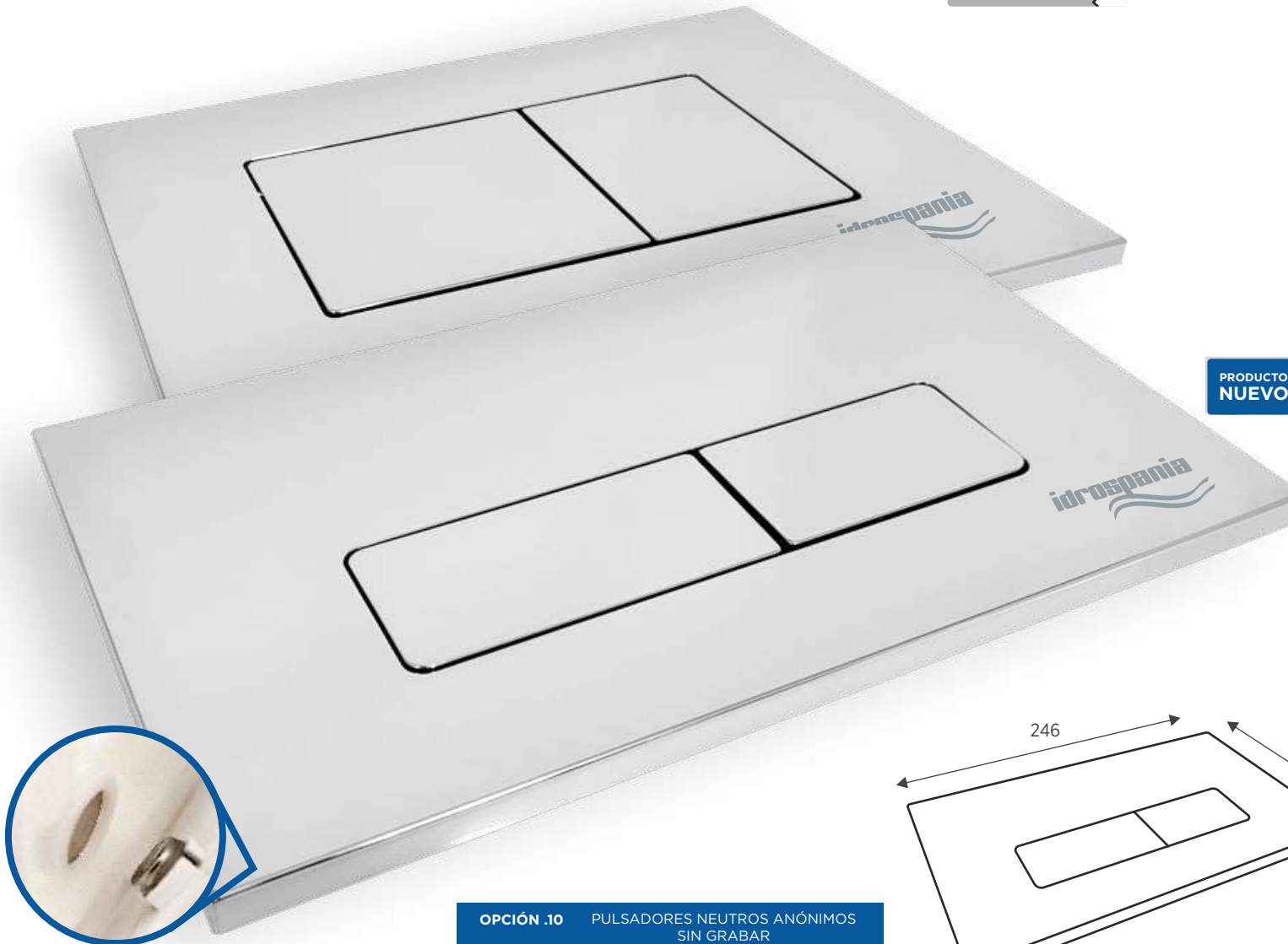



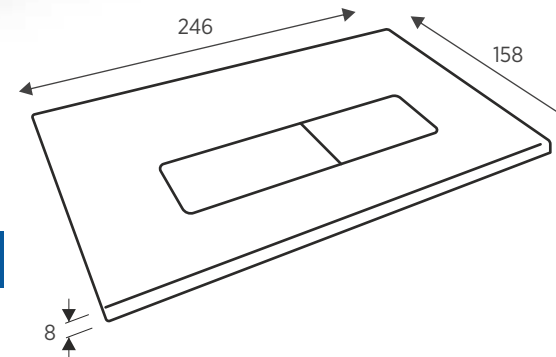





OPCIÓN .10 PULSADORES NEUTROS ANÓNIMOS
SIN GRABAR



RECAMBIOS CISTERNAS EMPOTRADAS EQUIPAMIENTO WC

RECAMBIOS PARA CISTERNAS EMPOTRADAS

Cod.	€
 30480 Mecanismo descargador	14,60
 30481 Grifo de alimentación	13,50
 30482 Latiguillo de alimentación	7,80
 30483 Llave de paso	9,05
 30484 Kit de herrajes de fijación Mod. 40220	10,75
 30497 Kit de herrajes de fijación Mod. 40230	12,25
 30498 Kit de herrajes de fijación Mod. 40240	9,50
 30499 Kit de herrajes de fijación Mod. 40320	7,40
 30485 Kit espárragos fijación inodoro	8,80

RECAMBIOS PARA PULSADORES CISTERNAS EMPOTRADAS

Cod.	€
 30493 Tornillos fijación pulsador 90mm	5,25
 30494 Flejes pulsador	5,25
 30495 Muelle pulsador	5,25

Cod.	€
 30812 Reductor de caudal descarga RIMLESS	2,05
 30486 Manguito recto	10,50
 30805 Conjunto manguito y tubo longitud 300 mm	19,45
 30453 Manguito evacuación salida horizontal excéntrico	19,40
 30813 Manguito adaptador Ø 90-110	6,85
 30487 Codo de evacuación 90°	10,50
 30806 Codo de evacuación 90° con doble posición anclaje para instalación inclinada	10,00
 30488 Conjunto soporte de codo Mod. 40220, 40230 y 40240	3,30
 30489 Conjunto tubo recto de salida	4,30
 30490 Tapa anticondensación	4,40
 30491 Conjunto acordeon y tapa registro	6,60
 30492 Kit juntas de goma	11,55
 30811 Tornillos fijación pulsador 120mm	5,20

RECAMBIOS CISTERNAS EMPOTRADAS EQUIPAMIENTO WC

PULSADORES PARA CISTERNAS EMPOTRADAS

REF.40210

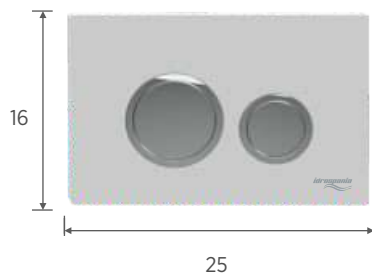

Cod.		€
30340	Placa de accionamiento doble pulsador mecánico ABS BLANCO / CROMO BRILLO	44,15



Cod.		€
30341	Placa de accionamiento doble pulsador mecánico ABS NEGRO / CROMO BRILLO	44,15



Cod.		€
30342	Placa de accionamiento doble pulsador mecánico ABS CROMO BRILLO / CROMO MATE	51,30



Cod.		€
30343	Placa de accionamiento doble pulsador mecánico ABS CROMO MATE / CROMO BRILLO	51,30

RECAMBIOS PARA CISTERNAS EMPOTRADAS

REF.40210

Cod.		€
30436	Descargador completo cisterna empotrada	15,35
30423	Grifo alimentación cisterna empotrada	14,95
30433	Kit de conexión(manguitos) y fijación inodoro para cisternas empotradas	18,10

PULSADORES PARA CISTERNAS EMPOTRADAS

REF.40200 / 40300

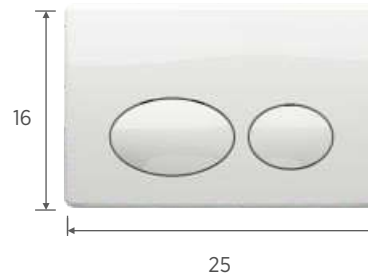

Cod.		€
30330	Placa de accionamiento doble pulsador mecánico ABS BLANCO	35,85



Cod.		€
30332	Placa de accionamiento doble pulsador mecánico ABS CROMO MATE	48,85



Cod.		€
30333	Placa de accionamiento doble pulsador mecánico ACERO INOX 304 BRILLO	180,60

RECAMBIOS PARA CISTERNAS EMPOTRADAS

REF.40200 / 40300

Cod.		€
30412	Descargador completo cisterna empotrada	29,95
30413	Grifo alimentación cisterna empotrada	29,95

CISTERNAS VISTAS DE CRISTAL



Doble descarga



Fácil y rápida instalación

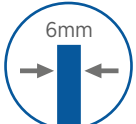

Cristal templado 6mm



Marco aluminio resistente corrosión

CISTERNAS VISTAS CRISTAL A SUELO EQUIPAMIENTO WC



Cod.		€
40430	Cisterna vista WHITE compacta para instalación de inodoros a suelo	396,95

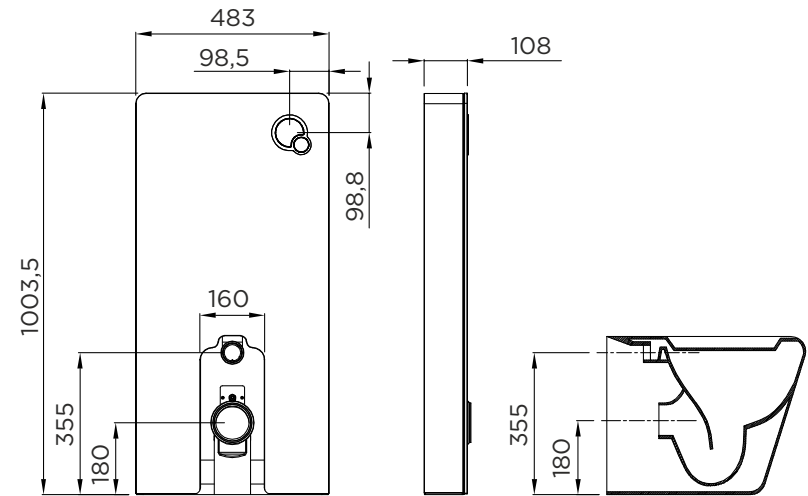

*Inodoro no incluido

Cod.		€
40420	Cisterna vista BLACK compacta para instalación de inodoros a suelo	396,95

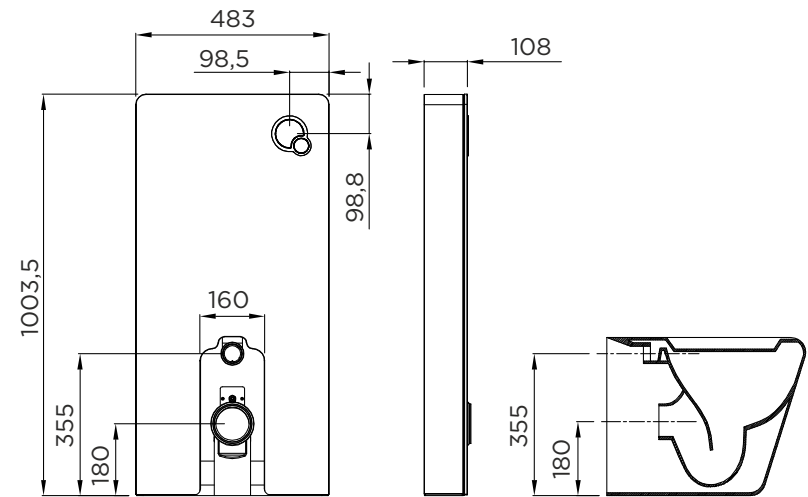

*Inodoro no incluido

CISTERNA VISTAS CRISTAL A SUELO
EQUIPAMIENTO WC



CISTERNA VISTAS CRISTAL A SUELO
EQUIPAMIENTO WC





ESTRUCTURAS DE BIDET

ESTRUCTURAS DE BIDET EQUIPAMIENTO WC

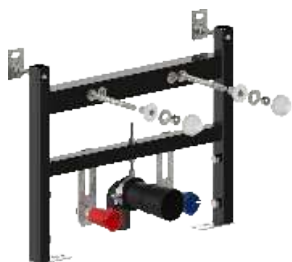

Cod. €

40500 Estructura para bidet suspendido h 420 mm 126,00

- UNIVERSAL
- Soportes de bidet ajustables a 18 o 25 cm
- Tomas ajustables
- Posición entrada ajustable
- Codo salida bidet Ø30-46 HDPE
- Soportes de pie galvanizados ajustables en altura 0-20 cm
- Pintura electrostática

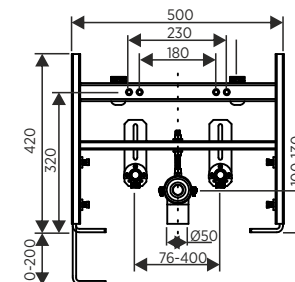

Cod. €

40510 Estructura para bidet suspendido h 820 mm 156,40

- UNIVERSAL
- Incluye accesorios de fijación a suelo y pared
- Tomas ajustables
- Rosca tornillos M12 para una instalación rápida
- Posición entrada ajustable
- Soportes de pie galvanizados ajustables en altura 0-20 cm
- Codo salida bidet Ø30-46 HDPE
- Soportes de bidet ajustables a 18 o 25 cm
- Pintura electrostática

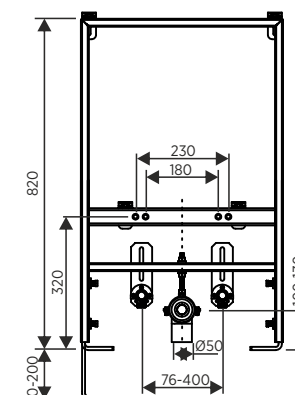

PRODUCTO NUEVO

Cod. €

40520 Estructura para bidet suspendido en ángulo 80,80

- Para fijación en paredes/suelo
- Estructura metálica resistente a corrosión
- Resistencia máxima 400 kg
- Fijación de sanitario ajustable 180 - 230 mm
- Certificado según las normas UNI EN 997:2007

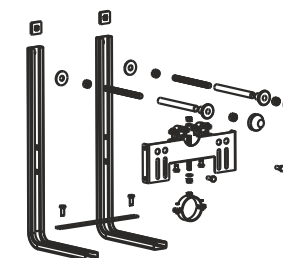

DESCARGADORES

PRODUCTO NUEVO

REGULACIÓN AUTOMÁTICA DE PULSADOR



Máxima adaptabilidad



Doble descarga



Fácil y rápida instalación



Instalación sin necesidad de desmontar la cisterna

CONSULTA VÍDEO INSTALACIÓN

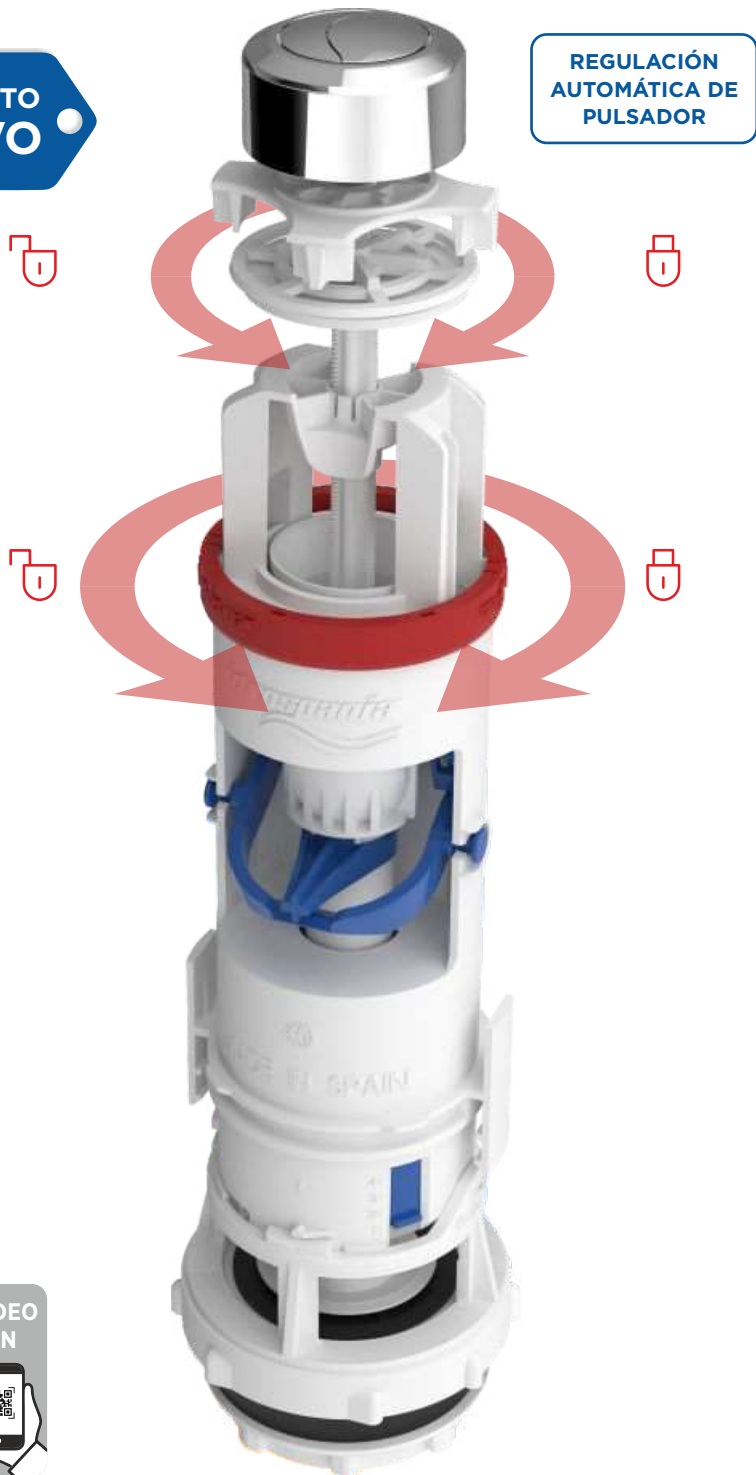

mod. ORCERA

DESCARGADORES EQUIPAMIENTO WC

FÁCIL Y RÁPIDA INSTALACIÓN

Sin necesidad de herramientas

DOBLE PULSADOR

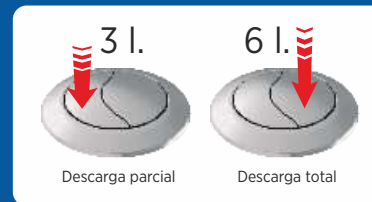

UNIVERSAL

Compatible con diámetros a partir de 12 mm

MÁXIMA ADAPTABILIDAD



1.- REGULACIÓN DESCARGA PARCIAL

La boya en la posición más alta indica menor descarga parcial, MÁS AHORRO

2.- REGULACIÓN DEL RESIDUAL

Posición 1: Residual mín. / Posición 4: Residual máx. Residual: Cantidad de agua restante después de la descarga total

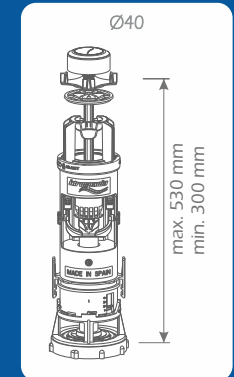
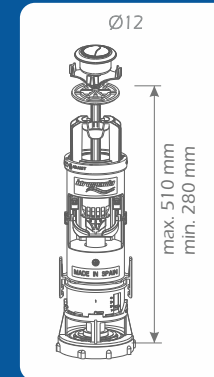
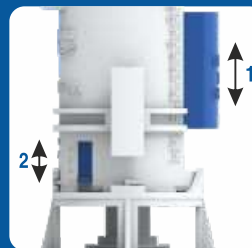

AGUJERO DE TAPA ENRASADO Ø40 Y RESULTADO Ø12



GOMA CIERRE CAUCHO



DESCARGADORES EQUIPAMIENTO WC

mod. ORCERA

Descargador doble pulsador con base roscada, base bayoneta y goma de asiento. mod. ORCERA

Descargador doble pulsador sin base roscada y con base bayoneta. mod. ORCERA

Descargador doble pulsador con base roscada, base bayoneta, con tornillos taza tanque HB y goma de asiento. mod. ORCERA

PRODUCTO NUEVO

Cod.	Emb.	€	📦
57010	BOLSA	19,90	22
57012	CAJA	21,50	16
 57010.1	BOX BOLSA	19,90	66
 57012.1	BOX CAJA	21,50	64

PRODUCTO NUEVO

Cod.	Emb.	€	📦
57011	BOLSA	18,25	27
57021	CAJA	19,80	16

PRODUCTO NUEVO

Cod.	Emb.	€	📦
57014	BOLSA	23,40	22
57015	CAJA	24,95	16

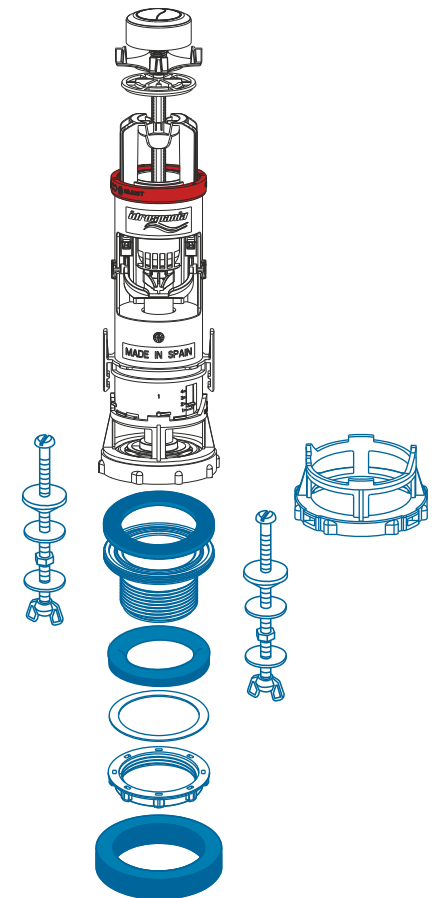
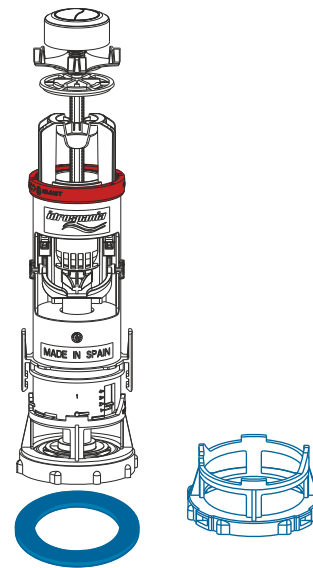
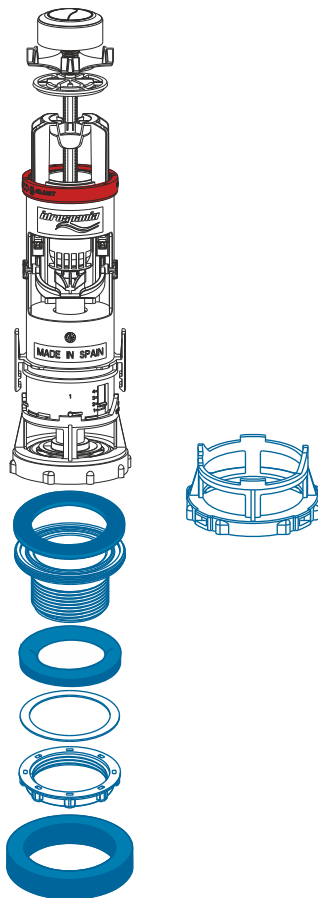



Máxima adaptabilidad



Descarga interrumpible

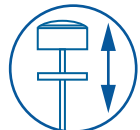

Pulsador ajustable en altura



Instalación sin necesidad de herramientas



Fácil y rápida instalación



Instalación sin necesidad de desmontar la cisterna

CONSULTA VÍDEO INSTALACIÓN



NOVEDAD!
ADAPTABLE A BASE RIMLESS



¡AHORA TODAVÍA MAS UNIVERSAL!

mod. LOJA

DESCARGADORES EQUIPAMIENTO WC

FÁCIL Y RÁPIDA INSTALACIÓN

Sin necesidad de herramientas

DESCARGA INTERRUPTIBLE

AHORRO DE CONSUMO DE AGUA

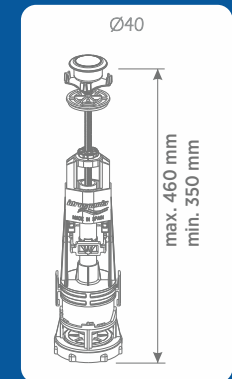
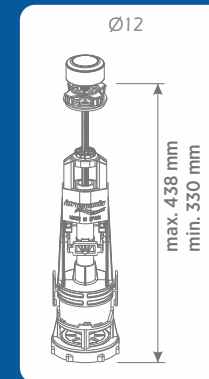
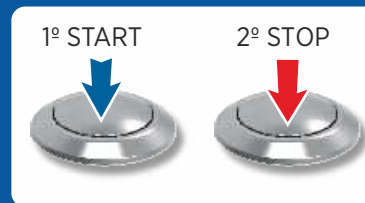

UNIVERSAL

Compatible con diámetros de 12 a 40 mm

MÁXIMA ADAPTABILIDAD

¡NOVEDAD!
Base RIMLESS



Base Roscada



Base Blanca



Base Gris



Base Bayoneta



MONTAJE EN CISTERNAS MODELO VICTORIA® DE ROCA® Y SIMILARES



No se utiliza ni el tornillo ni la tuerca de regulación

AGUJERO DE TAPA ENRASADO Ø40 Y RESALTADO Ø12



GOMA CIERRE CAUCHO



DESCARGADORES EQUIPAMIENTO WC

mod. LOJA

Descargador INTERRUMPIBLE
Con base roscada, base bayoneta y
goma de asiento.
mod. LOJA

Cod.	Emb.	€	
51010	BOLSA	17,80	25
51012	CAJA	19,35	16
51010.1	BOX BOLSA	17,80	75
51012.1	BOX CAJA	19,35	64

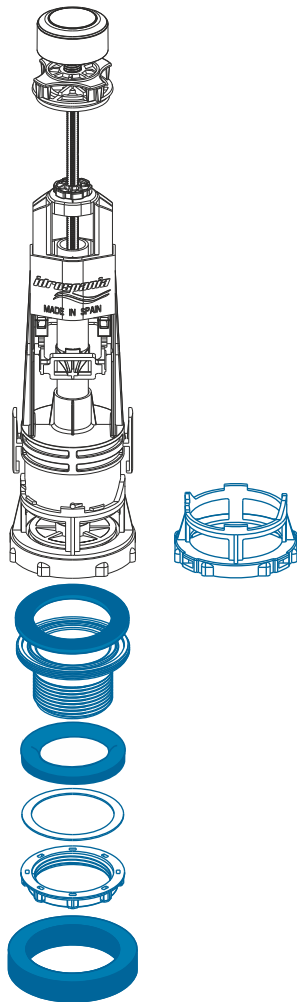

Descargador INTERRUMPIBLE
Sin base roscada y con base bayoneta.
mod. LOJA

Cod.	Emb.	€	
51011	BOLSA	16,15	32
51021	CAJA	17,65	16

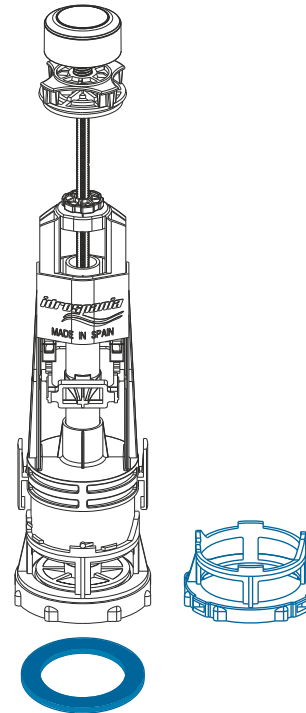

Descargador INTERRUMPIBLE
Con base roscada, base bayoneta, con tornillos
taza tanque HB y goma de asiento.
mod. LOJA

Cod.	Emb.	€	
51014	BOLSA	21,45	25
51015	CAJA	22,90	16

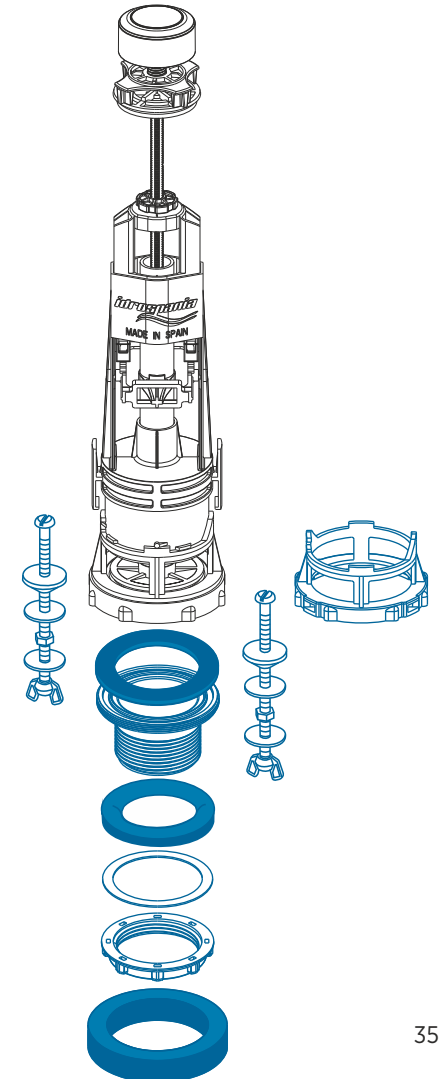



Máxima adaptabilidad



Doble descarga



Fácil y rápida instalación



Instalación sin necesidad de desmontar la cisterna

CONSULTA VÍDEO INSTALACIÓN



Pulsador easy-click



Cable de ACERO INOXIDABLE y terminales de LATÓN

mod. DENIA

DESCARGADORES EQUIPAMIENTO WC

FÁCIL Y RÁPIDA INSTALACIÓN

El sistema de cable facilita el montaje
El pulsador se puede colocar en la parte superior, lateral o frontal de la cisterna

DOBLE PULSADOR CON CABLE

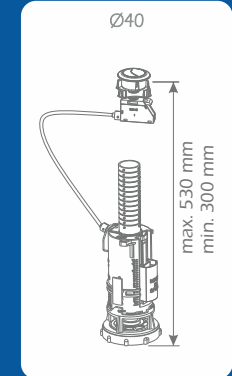
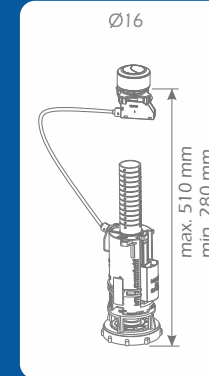

UNIVERSAL

Cubre todas las excentricidades de las cisternas

MÁXIMA ADAPTABILIDAD



1.- REGULACIÓN DESCARGA PARCIAL

La boya en la posición más alta indica menor descarga parcial, MÁS AHORRO

2.- REGULACIÓN DEL RESIDUAL

Posición 1: Residual mín. / Posición 4: Residual máx.
Residual: Cantidad de agua restante después de la descarga total

AGUJERO DE TAPA ENRASADO Ø40 Y RESALTADO Ø16



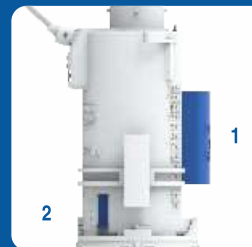

GOMA CIERRE CAUCHO



DESCARGADORES

EQUIPAMIENTO WC

Descargador doble pulsador de CABLE
Con base roscada, base bayoneta y
goma de asiento.
mod. DENIA

Cod.	Emb.	€	
53010	BOLSA	21,75	25
53012	CAJA	23,40	16
 53010.1	BOX BOLSA	21,75	75
 53012.1	BOX CAJA	23,40	64

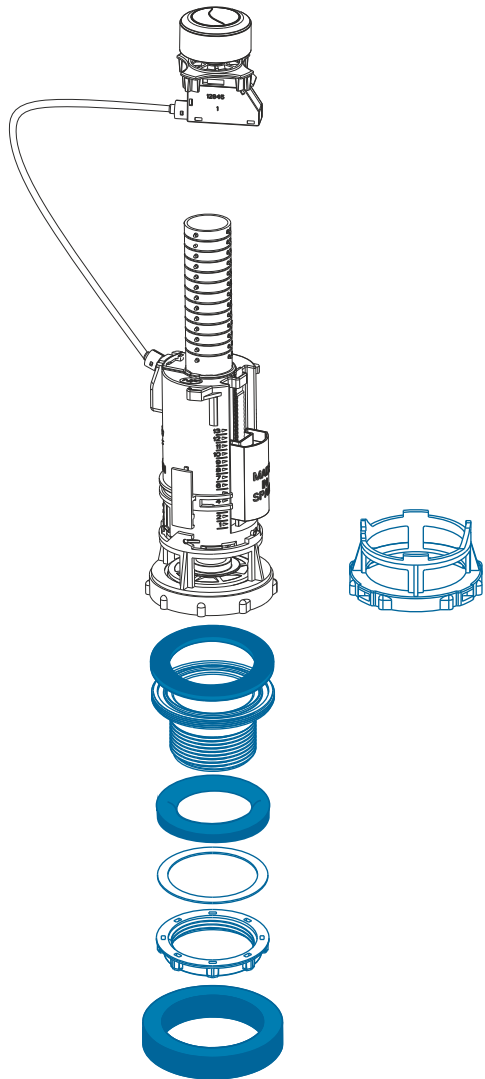

mod. DENIA

Descargador doble pulsador de CABLE
Sin base roscada y con base bayoneta.
mod. DENIA

Cod.	Emb.	€	
53011	BOLSA	19,45	32
53021	CAJA	20,95	16

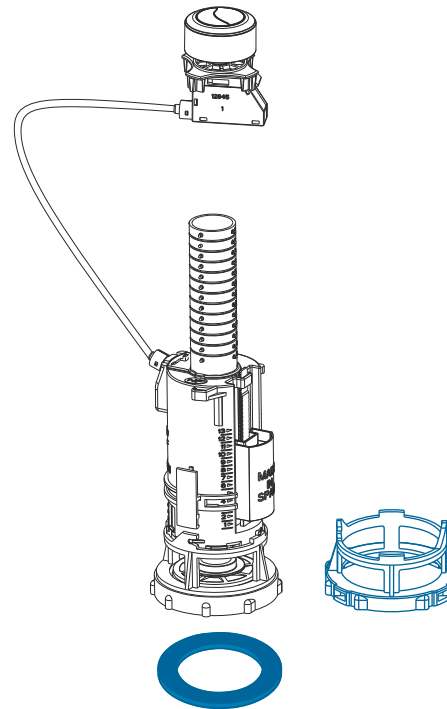

Descargador doble pulsador de CABLE,
Con base roscada, base bayoneta, con
tornillos taza tanque HB y goma de
asiento.
mod. DENIA

Cod.	Emb.	€	
53014	BOLSA	25,00	25
53015	CAJA	26,20	16

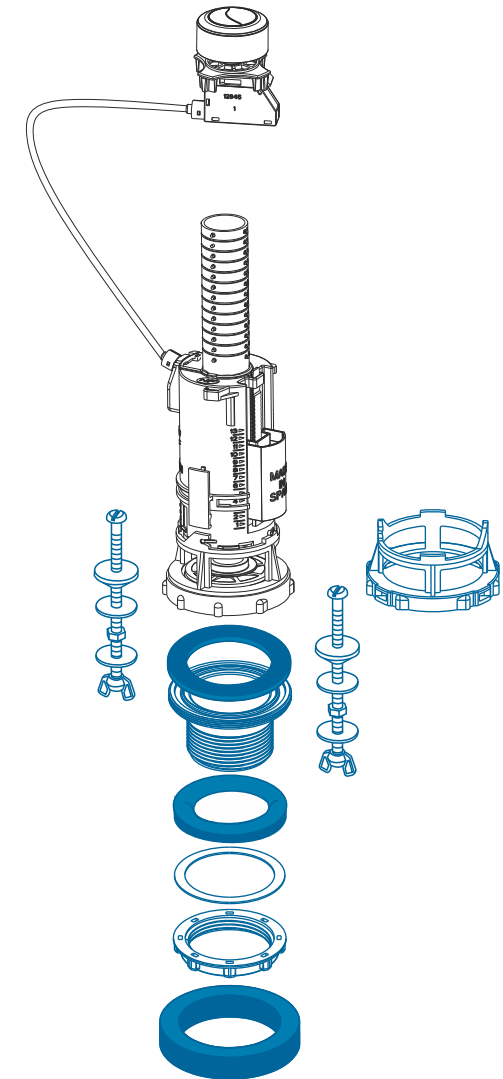



Fijación a la tapa
ANTIVANDÁLICO



Doble
descarga



Fácil y rápida
instalación



Instalación sin
necesidad de
desmontar la
cisterna

- Pulsador
easy-click
- 1
 - 2
 - 3 **click!**
- Cable de ACERO
INOXIDABLE y
terminales de
LATÓN

Fabricado con materiales plásticos de alta calidad y anticlúreos
UN DESCARGADOR UNIVERSAL Y ANTIVANDÁLICO PARA TODOS
LOS MODELOS DE CISTERNAS CERÁMICAS

mod. DENIA PLUS

DESCARGADORES EQUIPAMIENTO WC

FÁCIL Y RÁPIDA INSTALACIÓN

El sistema de cable facilita el montaje

DOBLE PULSADOR CON CABLE

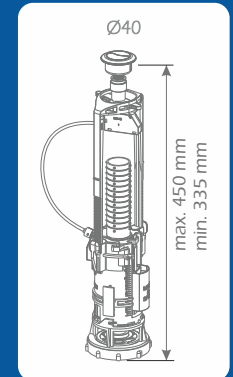
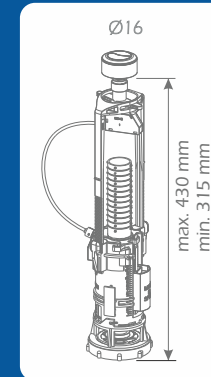

UNIVERSAL

Cubre todas las excentricidades de las cisternas

ANTIVANDÁLICO

Gracias al sistema de bloqueo a la tapa de la cisterna

ADAPTABLE AL SISTEMA TRADICIONAL

ADAPTABLE AL SISTEMA ACTUAL (BASES GRIS Y BLANCA)



1.- REGULACIÓN DESCARGA PARCIAL

La boya en la posición más alta indica menor descarga parcial, MÁS AHORRO

2.- REGULACIÓN DEL RESIDUAL

Posición 1: Residual mín. / Posición 4: Residual máx.
Residual: Cantidad de agua restante después de la descarga total

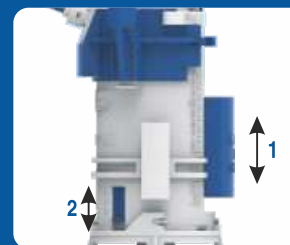

AGUJERO DE TAPA ENRASADO Ø40 Y RESULTADO Ø16

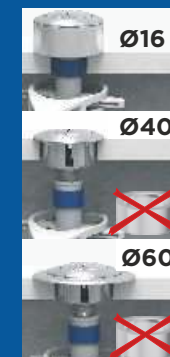

GOMA CIERRE CAUCHO



Adaptador 30319 (pág 109)

DESCARGADORES EQUIPAMIENTO WC

Descargador pulsador de CABLE de doble descarga antivandálico (fijación a la tapa) con base y goma de asiento.
mod. DENIA PLUS

Cod.	Emb.	€	
56010	BOLSA	22,40	14

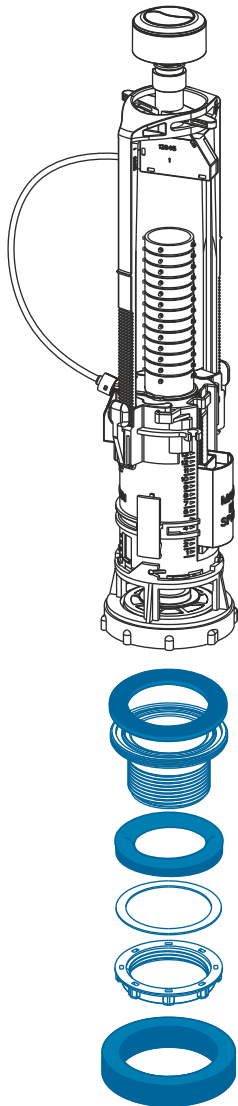

mod. DENIA PLUS

Descargador pulsador de CABLE de doble descarga antivandálico (fijación a la tapa) sin base.
mod. DENIA PLUS

Cod.	Emb.	€	
56011	BOLSA	20,25	18

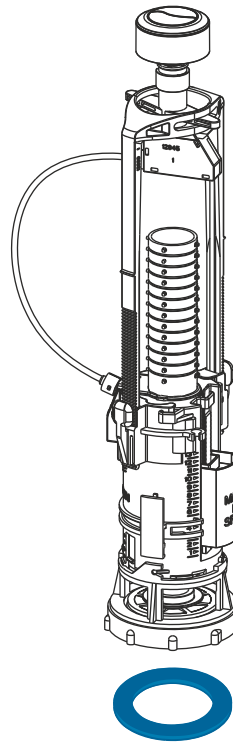

Descargador pulsador de CABLE de doble descarga antivandálico (fijación a la tapa) con base con tornillos taza tanque y goma de asiento.
mod. DENIA PLUS

Cod.	Emb.	€	
56014	BOLSA	25,45	14

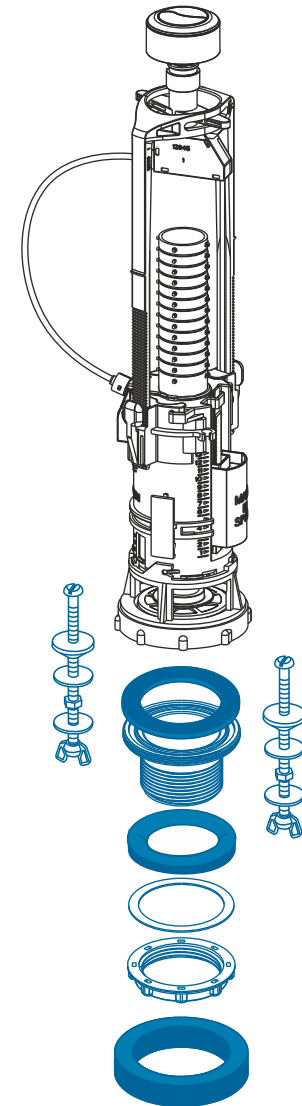



Fijación a la tapa
ANTIVANDÁLICO



Doble
descarga



Fácil y rápida
instalación



Instalación sin
necesidad de
desmontar la
cisterna

mod. PALMA

DESCARGADORES EQUIPAMIENTO WC

FÁCIL Y RÁPIDA INSTALACIÓN

Con sistema de fijación a la tapa

DOBLE PULSADOR



UNIVERSAL

Compatible con el sistema tradicional de rosca

ANTIVANDÁLICO

Gracias al sistema de bloqueo a la tapa de la cisterna

ADAPTABLE AL SISTEMA TRADICIONAL



1.- REGULACIÓN DESCARGA PARCIAL

La boya en la posición más alta indica menor
descarga parcial, MÁS AHORRO

2.- REGULACIÓN DEL RESIDUAL

Posición 1: Residual mín. / Posición 4: Residual máx.
Residual: Cantidad de agua restante después de la
descarga total

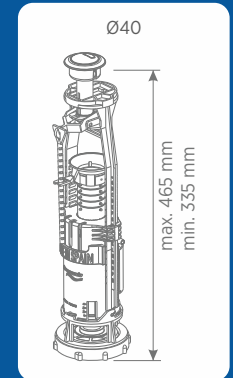
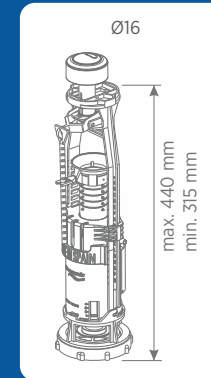
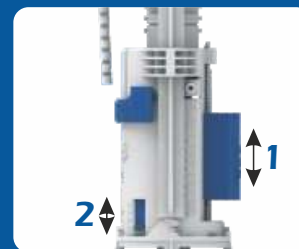

AGUJERO DE TAPA
ENRASADO Ø40 Y
RESALTADO Ø16

GOMA CIERRE
CAUCHO



DESCARGADORES EQUIPAMIENTO WC

Descargador doble de pulsador mecánico,
Antivandálico (fijación a la tapa) con base
y goma de asiento.
mod. PALMA

Cod.	Emb.	€	
22010	BOLSA	17,65	18

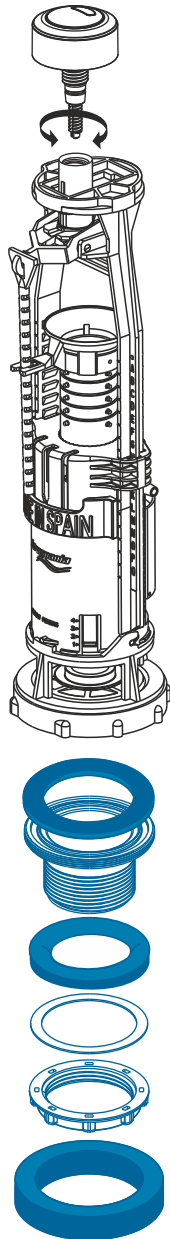

mod. PALMA

Descargador doble de pulsador mecánico,
Antivandálico (fijación a la tapa) sin base.
mod. PALMA

Cod.	Emb.	€	
22011	BOLSA	15,15	25

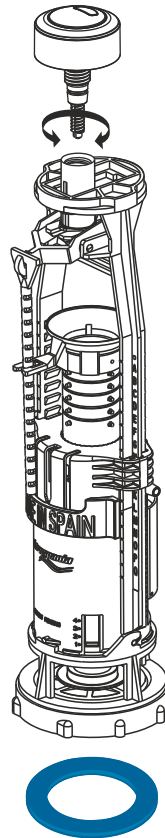

Descargador doble de pulsador mecánico,
Antivandálico (fijación a la tapa) con base
con tornillos taza tanque y goma de asiento.
mod. PALMA

Cod.	Emb.	€	
22014	BOLSA	21,75	20

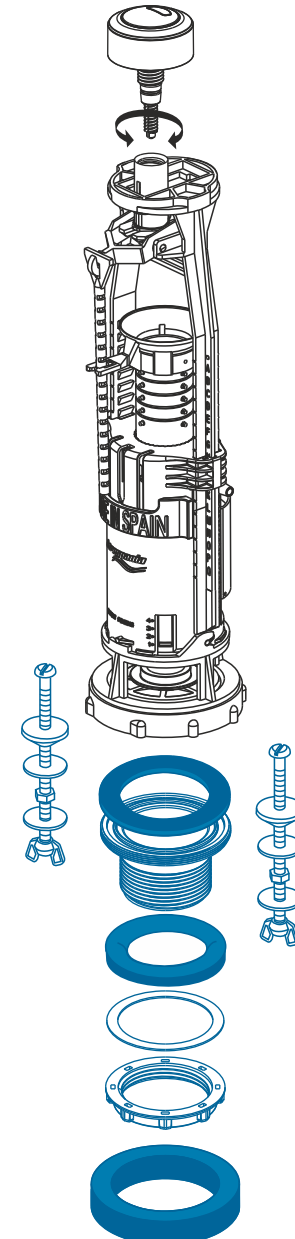



- Pulsador easy-click
- 1
 - 2
 - 3
- Cable de ACERO INOXIDABLE y terminales de LATÓN

mod. JAVEA

DESCARGADORES EQUIPAMIENTO WC

FÁCIL Y RÁPIDA INSTALACIÓN

GOMA CIERRE CAUCHO

DESCARGA SIMPLE



UNIVERSAL

Cubre todas las excentricidades de las cisternas

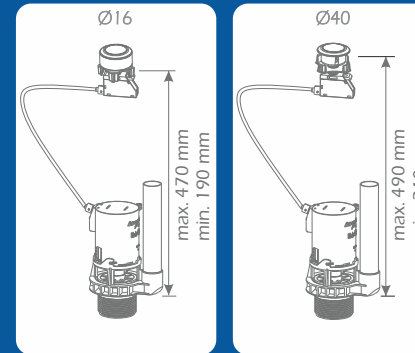

BASE UNIVERSAL COMPACTA



AGUJERO DE TAPA ENRASADO Ø40 Y RESULTADO Ø16



Adaptador [30319](#) (pág 99)

Descargador COMPACTO SIMPLE de CABLE, Con base universal compacta y goma de asiento. mod. JAVEA

Cod.	Emb.	€	
54000	BOLSA	16,65	22

Descargador COMPACTO SIMPLE de CABLE, Con base universal compacta, tornillos taza-tanque HB y goma de asiento. mod. JAVEA

Cod.	Emb.	€	
54004	BOLSA	19,85	22

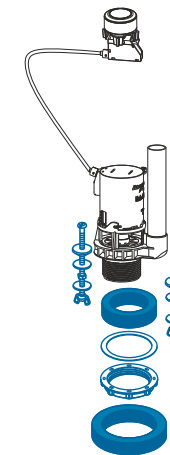
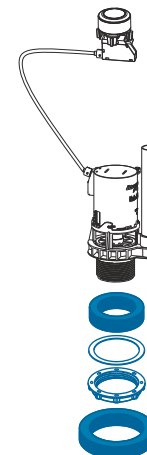

mod. UNIVERSAL

DESCARGADORES
EQUIPAMIENTO WC

ADAPTABLE AL SISTEMA
TRADICIONAL

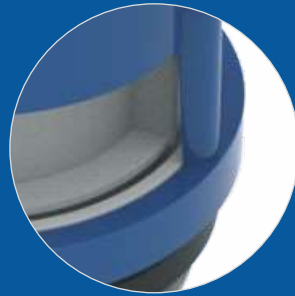

Tirador



Fácil y rápida
instalación

Descargador UNIVERSAL CON BASE.
mod. UNIVERSAL

Cod.	Emb.	€	
27012	BOLSA	6,70	45



Descargador UNIVERSAL SIN BASE.
mod. UNIVERSAL

Cod.	Emb.	€	
27013	BOLSA	5,00	50

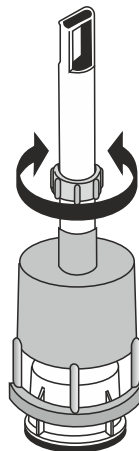

FÁCIL Y RÁPIDA INSTALACIÓN

GOMA CIERRE CAUCHO



ADAPTABLE AL SISTEMA
TRADICIONAL

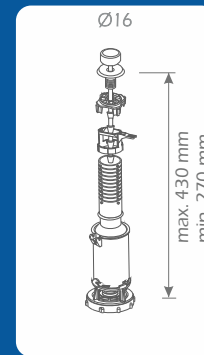

Descargador TIRADOR, con base y goma de asiento. mod. ALCORA

Cod.	Emb.	€	
25010	BOLSA	11,65	22



mod. ORCERA

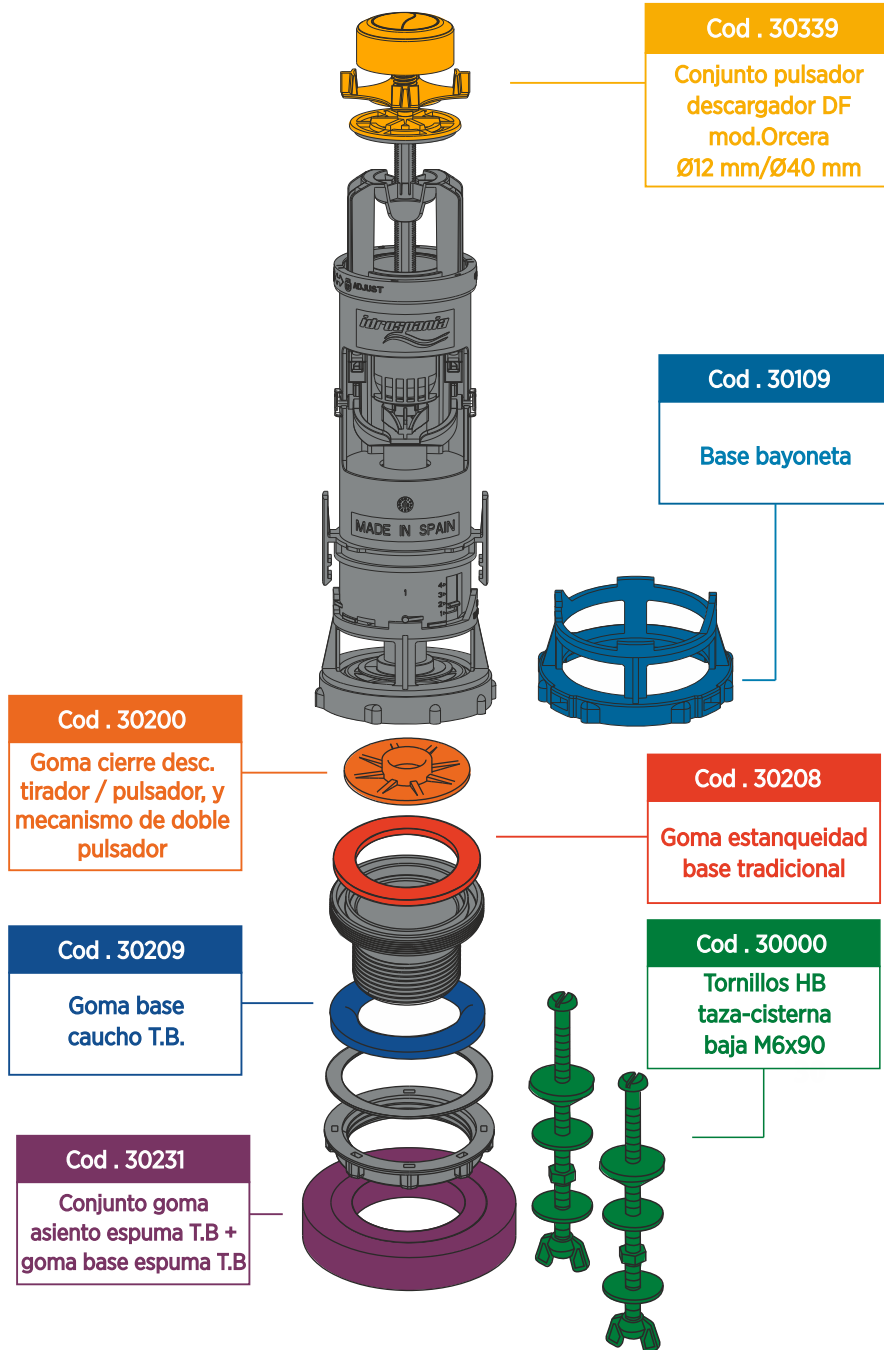

mod. LOJA

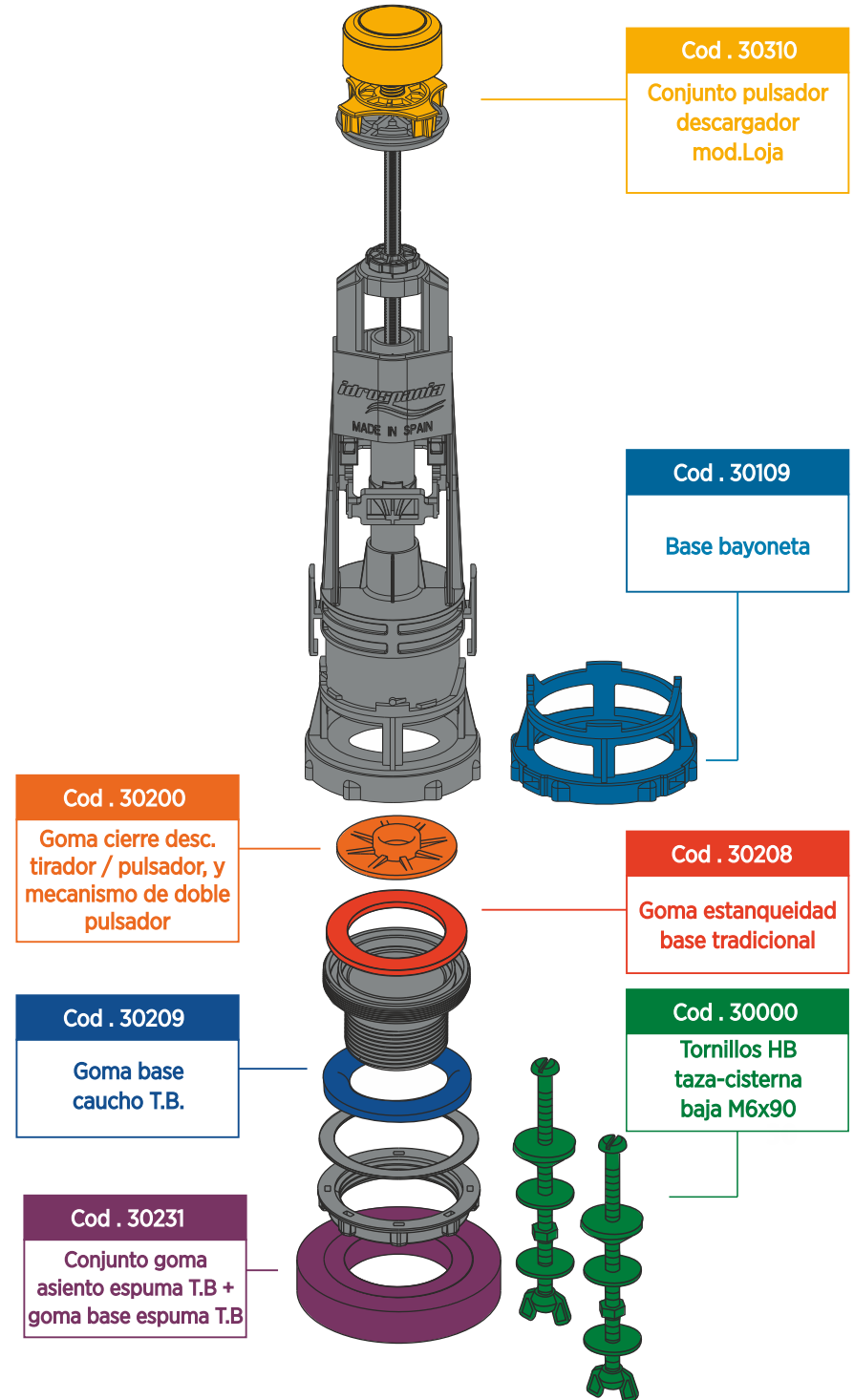

mod. DENIA

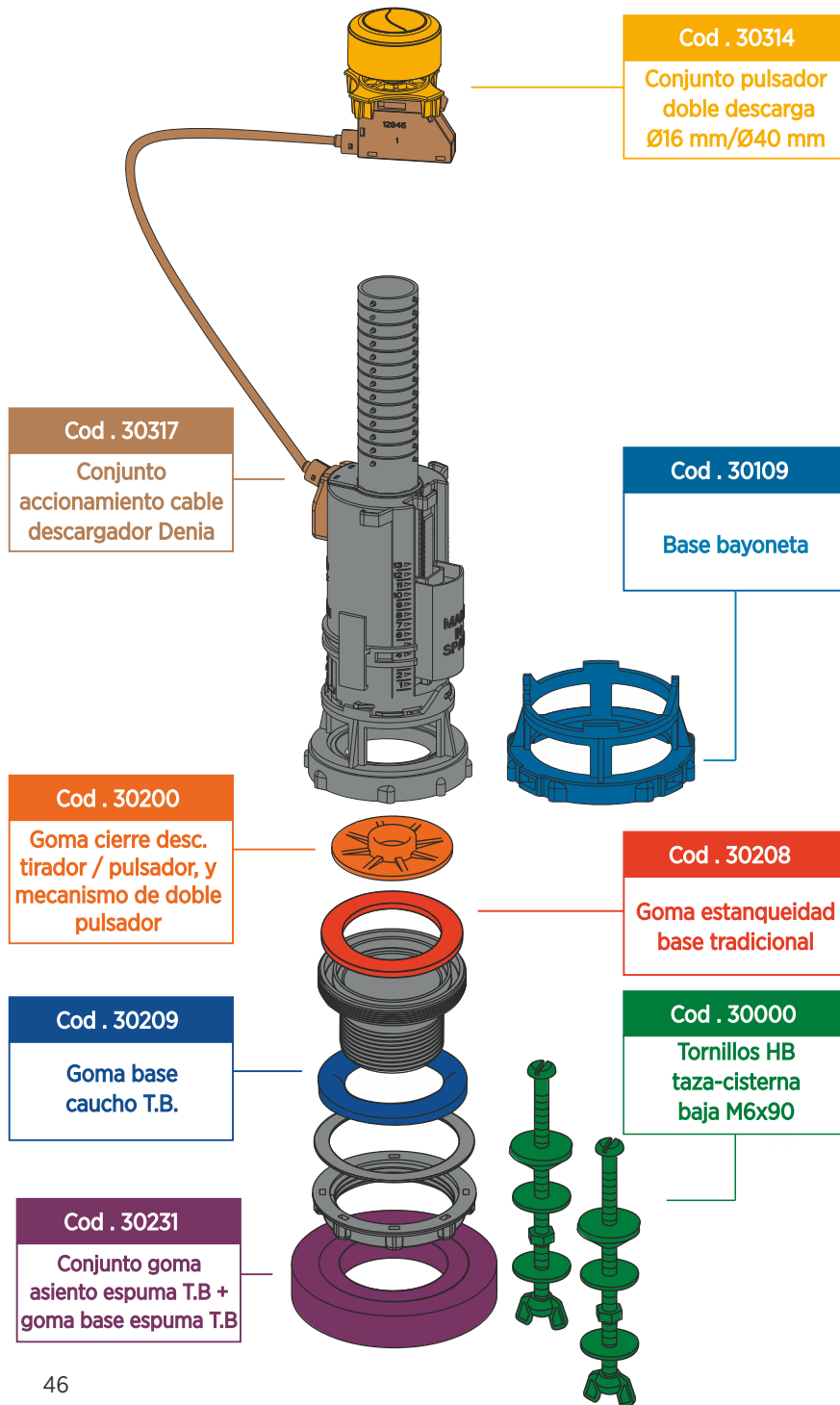

mod. DENIA PLUS

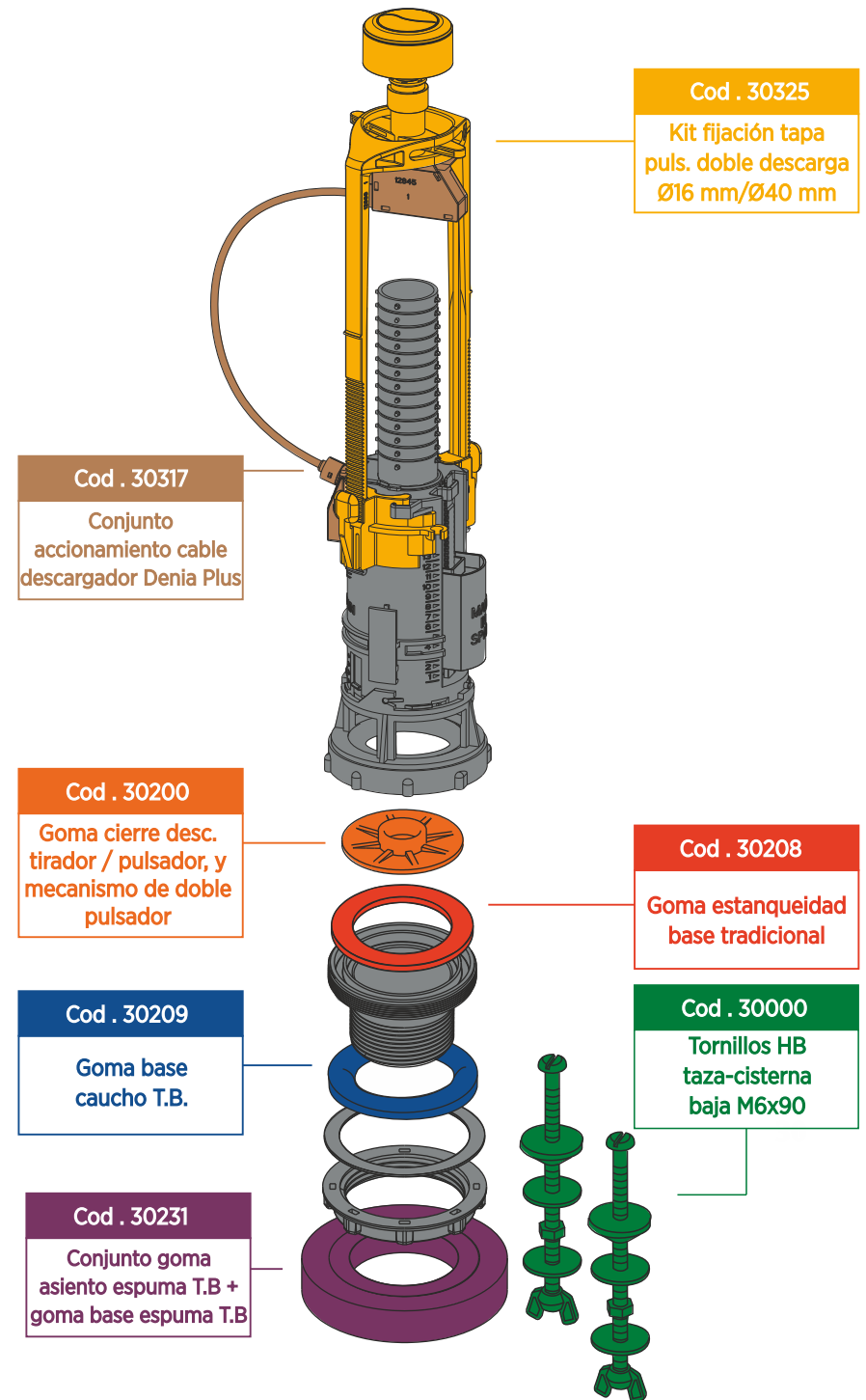

mod. PALMA

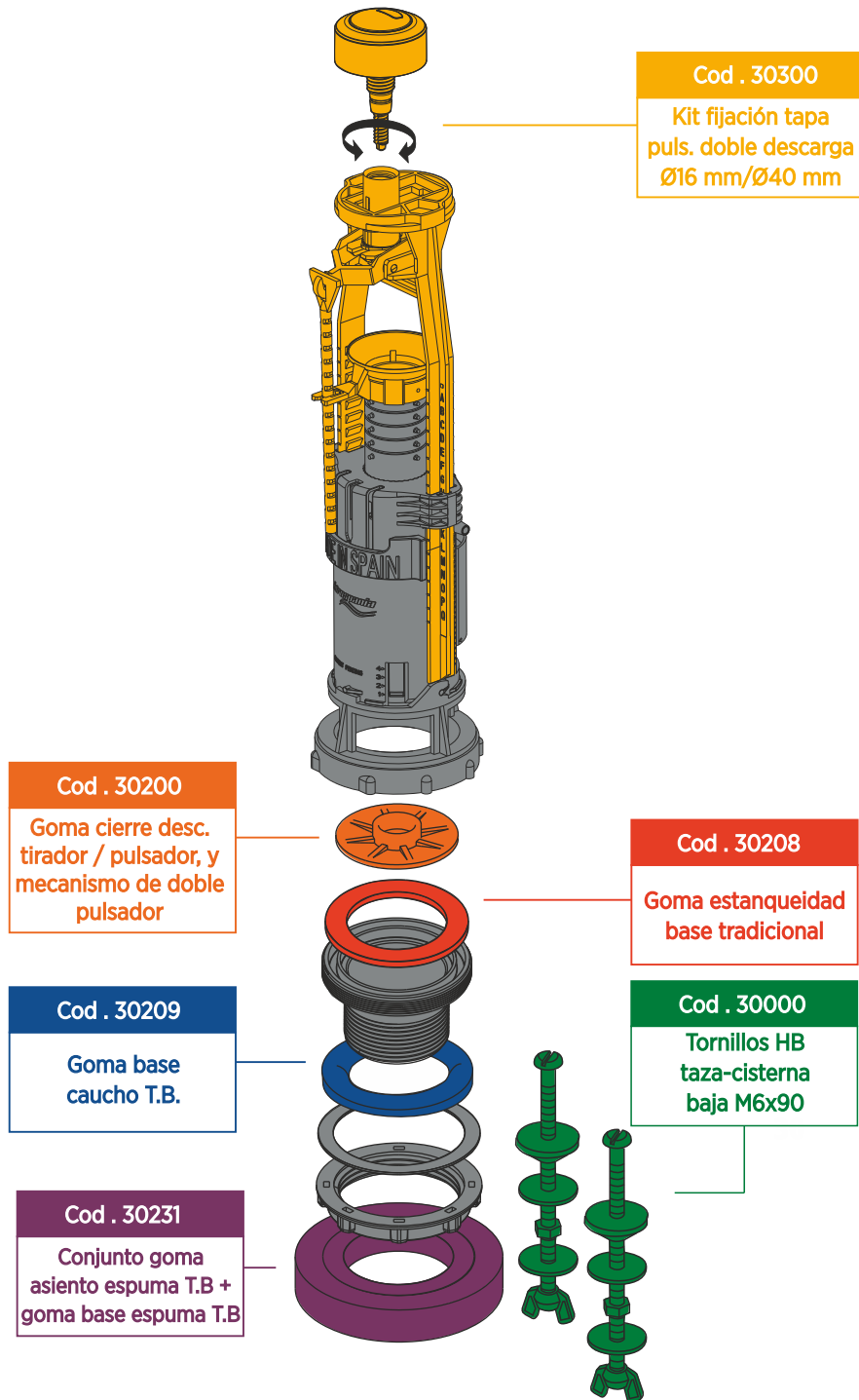

mod. JAVEA

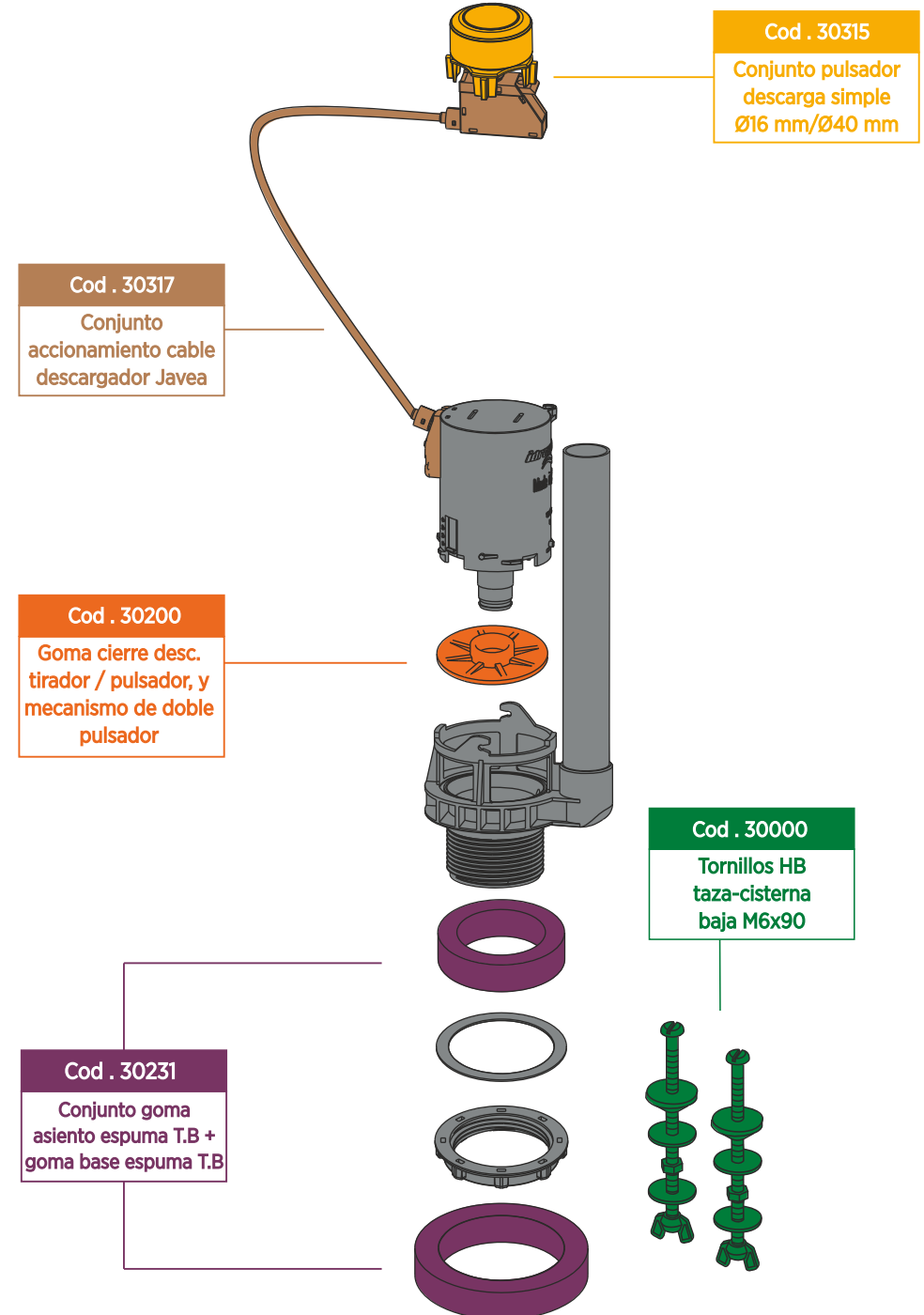

mod. UNIVERSAL

mod. ALCORA

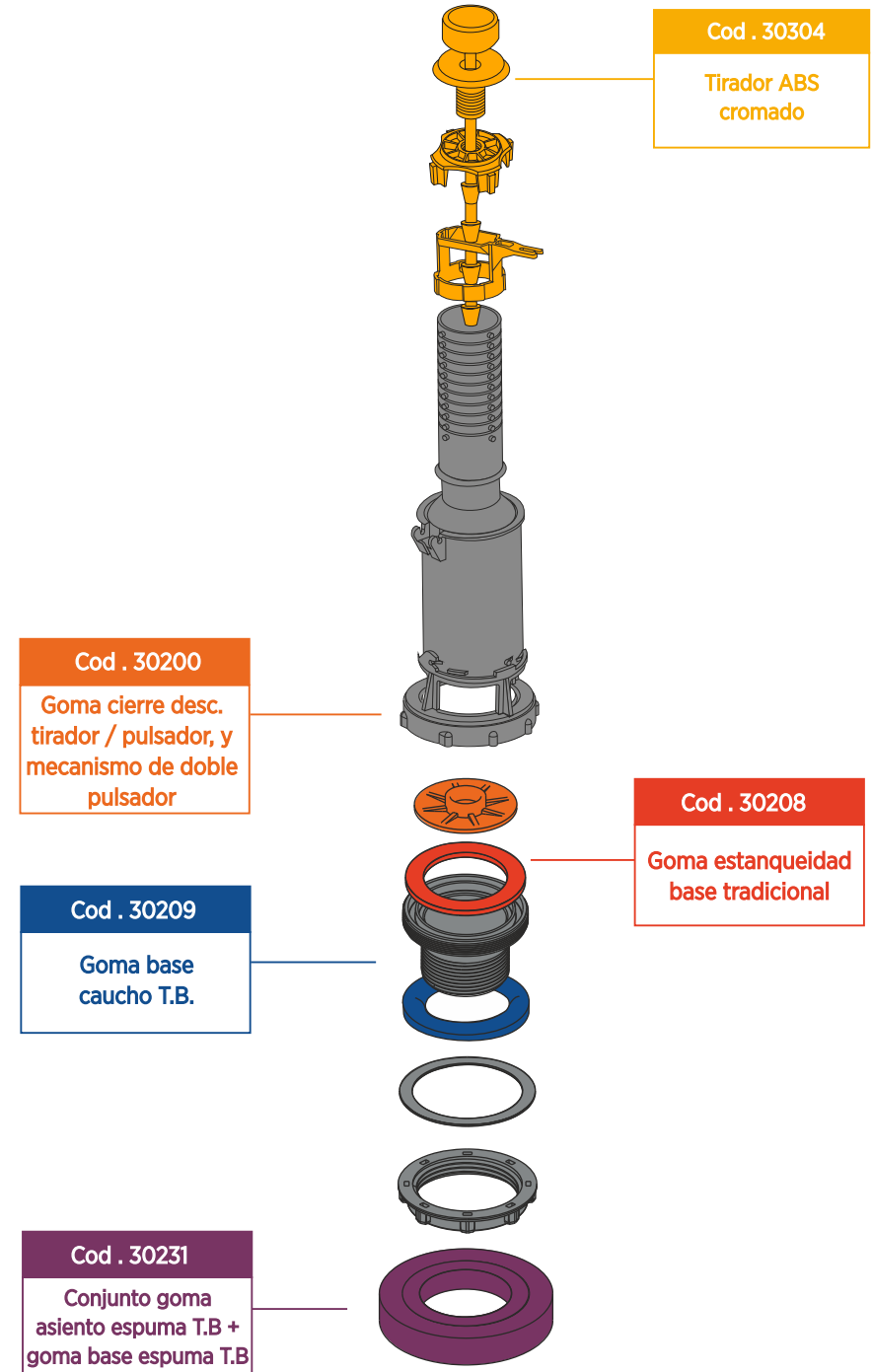
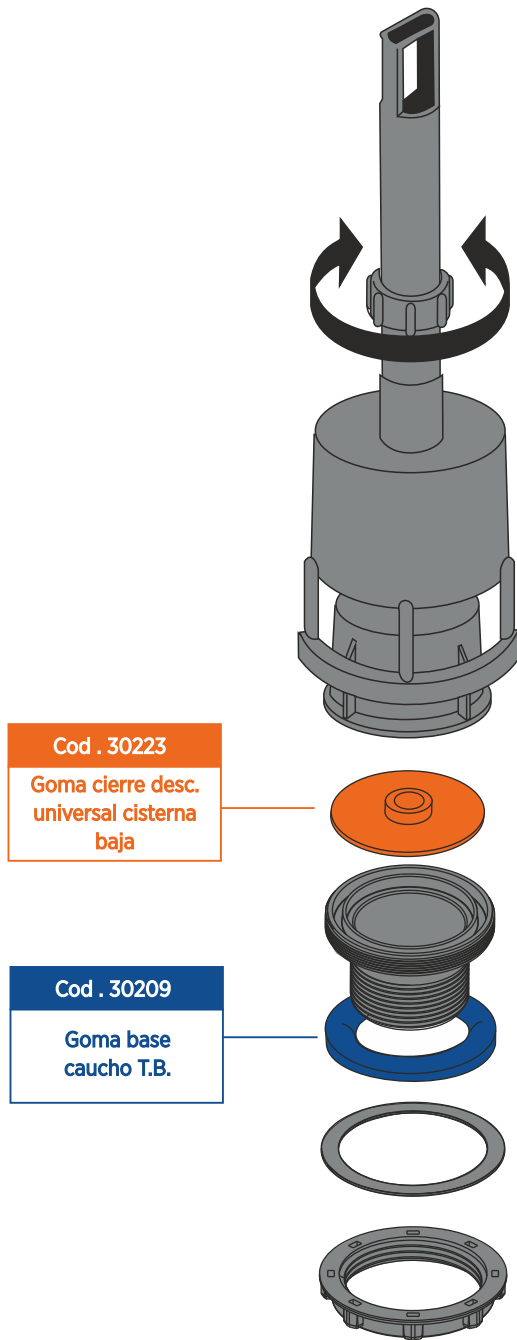



MECANISMOS COMPLETOS

mod. DENIA

DOBLE PULSADOR

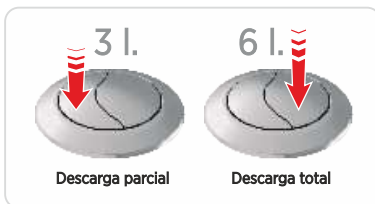

+

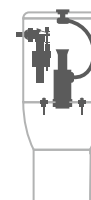

Mecanismo doble pulsador de CABLE, base universal modelo Denia + grifo alimentación LATERAL modelo Servo

Cod.	Emb.	€	
53100	BOLSA	34,60	15

BASE UNIVERSAL COMPACTA



+

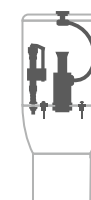

Mecanismo doble pulsador de CABLE, base universal modelo Denia + grifo alimentación INFERIOR telescópico modelo Servo

Cod.	Emb.	€	
53200	BOLSA	34,95	16

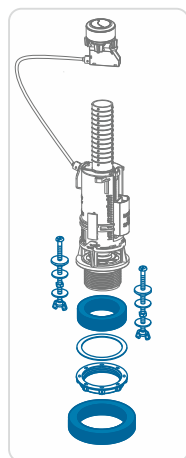

+

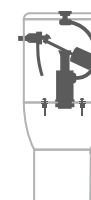

Mecanismo doble pulsador de CABLE, base universal modelo Denia + grifo alimentación LATERAL modelo Lina

Cod.	Emb.	€	
53300	BOLSA	29,50	16

+



Mecanismo doble pulsador de CABLE, base universal modelo Denia + grifo alimentación INFERIOR telescópico modelo Ana

Cod.	Emb.	€	
53400	BOLSA	32,20	15



MECANISMOS COMPLETOS
EQUIPAMIENTO WC

mod. LOJA

DESCARGA INTERRUPTIBLE

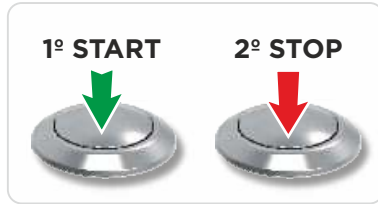

BASE UNIVERSAL COMPACTA

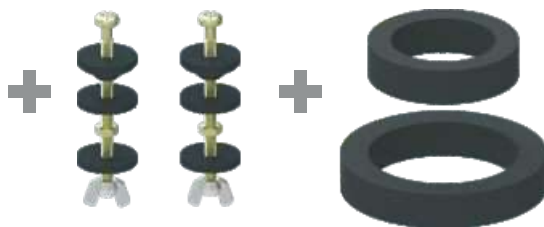
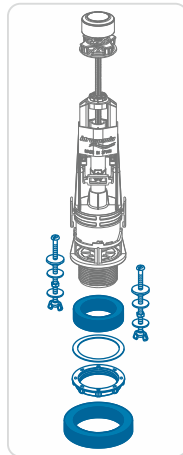

+

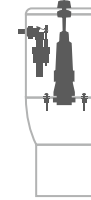

Mecanismo SIMPLE E INTERRUPTIBLE
base universal modelo Loja + grifo
alimentación LATERAL modelo Servo

Cod.	Emb.	€	
51100	BOLSA	28,70	16

+

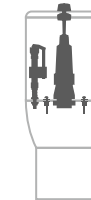

Mecanismo SIMPLE E INTERRUPTIBLE
base universal modelo Loja + grifo
alimentación INFERIOR telescópico
modelo Servo

Cod.	Emb.	€	
51200	BOLSA	28,95	16

+



Mecanismo SIMPLE E INTERRUPTIBLE
base universal modelo Loja + grifo
alimentación LATERAL modelo Lina

Cod.	Emb.	€	
51300	BOLSA	23,60	16

+



Mecanismo SIMPLE E INTERRUPTIBLE
base universal modelo Loja + grifo
alimentación INFERIOR telescópico
modelo Ana

Cod.	Emb.	€	
51400	BOLSA	26,20	16

MECANISMOS COMPLETOS EQUIPAMIENTO WC



MÁXIMA
ADAPTABILIDAD

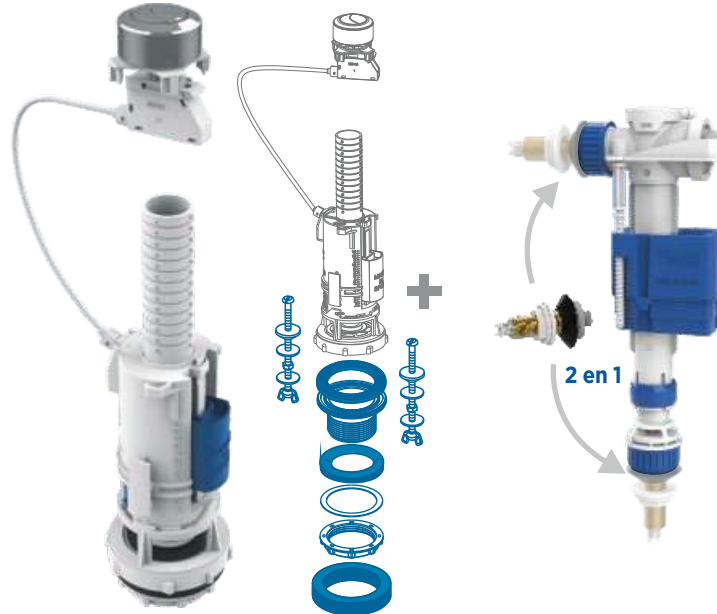

Mecanismo doble pulsador de CABLE modelo Denia, con tornillos taza tanque HB y GOMA de asiento + grifo de alimentación INFERIOR O LATERAL modelo Duo Servo

Cod.	Emb.	€	
53714	BOLSA	37,00	15
53715	CAJA	38,80	10

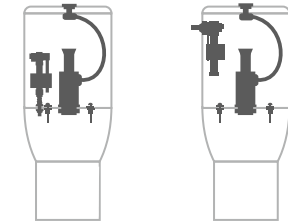

MÁXIMA
ADAPTABILIDAD



¡NOVEDAD!

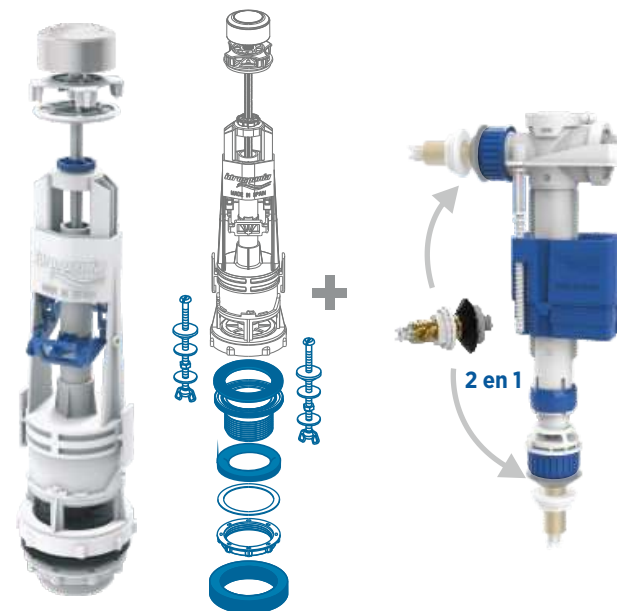

Mecanismo de pulsador SIMPLE E INTERRUPTIBLE modelo Loja, con tornillos taza tanque HB y GOMA de asiento + grifo de alimentación INFERIOR O LATERAL modelo Duo Servo

Cod.	Emb.	€	
51714	BOLSA	33,45	15
51715	CAJA	34,85	10

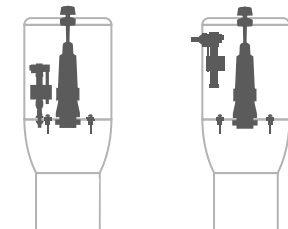



GRIFOS DE ALIMENTACIÓN

mod. DUO SERVO ORIENTABLE

GRIFOS DE ALIMENTACIÓN EQUIPAMIENTO WC



Cabezal orientable 180°

- Ahorro de espacio
- Evita el contacto con el descargador

¡IMPORTANTE!
Para un correcto funcionamiento, el filtro debe estar instalado. Retirar **SOLO** para limpieza y mantenimiento

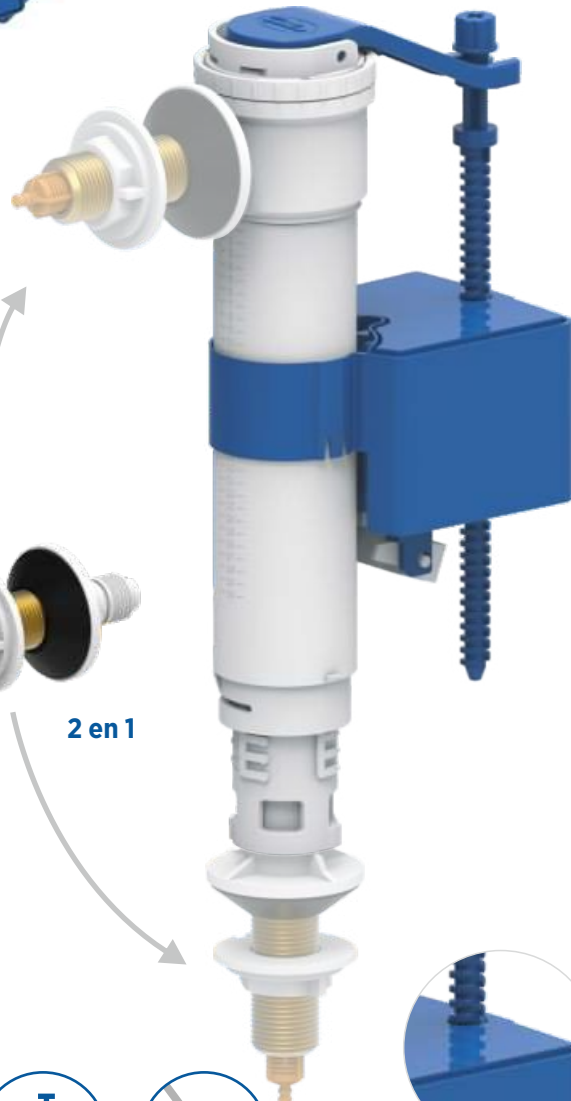

2 en 1



Cierre instantáneo sistema servo

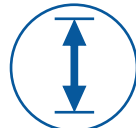

Altura regulable



Filtro de agua incorporado



Fácil y rápida instalación



Llenado rápido y silencioso

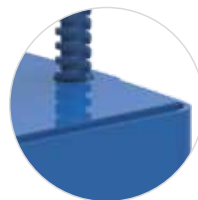

Vaso con boya interna

Características Técnicas:

- ▶ Presiones de trabajo desde 0,2 a 16 bar.
- ▶ Rápida instalación.
- ▶ Compatible con todas las cisternas cerámicas.
- ▶ Fabricado con polímeros plásticos de alta calidad y anticalcáreos.
- ▶ Ahorro de agua mediante retardo en la apertura de llenado.
- ▶ Casquillo latón 3/8"
- ▶ Sistema antirretorno

Grifo flotador compacto alimentación lateral o inferior modelo Duo Servo orientable

Cod.	Emb.	€	
21600	BOLSA	16,20	45
21601	CAJA	17,30	27
21601.1	BOX CAJA	17,30	81

Asegúrese de que el casquillo está enroscado completamente

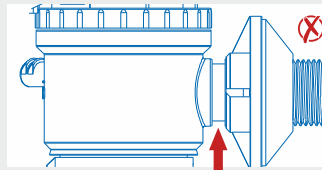

INCORRECTO: Hay un hueco

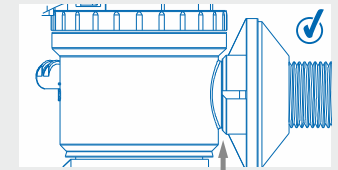

CORRECTO: No hay un hueco

2 EN 1: Con diferentes montajes se configura el grifo para alimentación inferior o lateral
BOYA REGULABLE EN ALTURA
TELESCÓPICO AJUSTABLE EN ALTURA

LATERAL

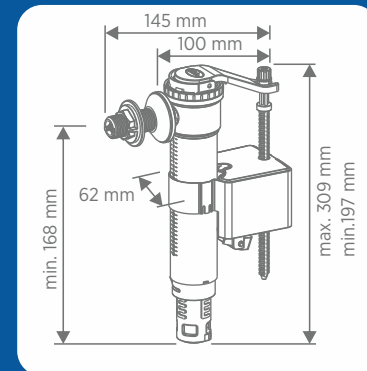
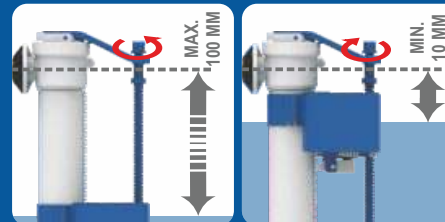

INFERIOR

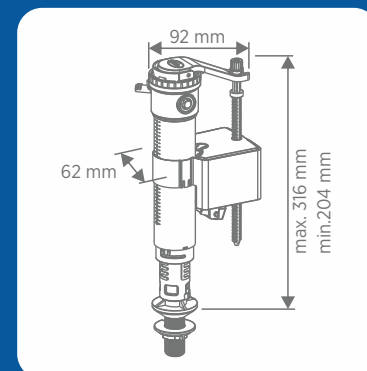
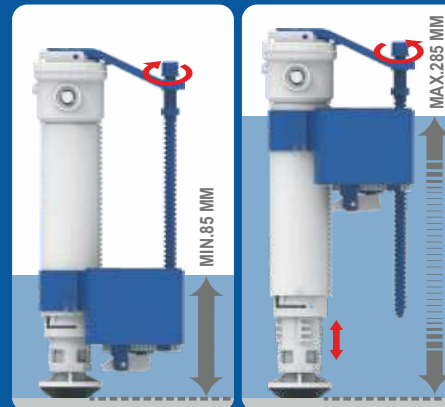

GRIFOS DE ALIMENTACIÓN EQUIPAMIENTO WC

mod. DUO SERVO

Diseño de pasador y sello que proporciona un óptimo comportamiento



Grifo flotador compacto alimentación lateral o inferior modelo Duo Servo

	Cod.	Emb.	€	
CASQUILLO LATÓN 3/8"	21100	BOLSA	15,00	45
CASQUILLO LATÓN 3/8"	21101	CAJA	16,10	27
CASQUILLO LATÓN 3/8"	21101.1	BOX CAJA	16,10	81
CASQUILLO LATÓN 1/2"	21103	BOLSA	15,55	45

Características Técnicas:

- ▶ Presiones de trabajo desde 0,2 a 16 bar. Resiste picos de presión hasta 21 bar.
- ▶ Rápida instalación.
- ▶ Compatible con todas las cisternas cerámicas.
- ▶ Fabricado con polímeros plásticos de alta calidad y anticalcáreos.
- ▶ Casquillo latón 3/8" · 1/2"
- ▶ Sistema antirretorno

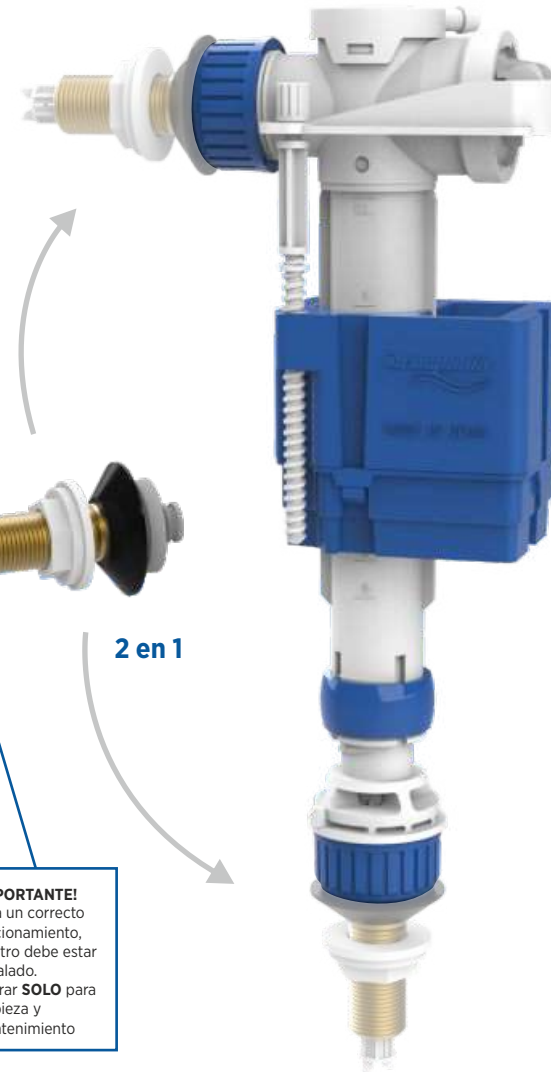

Cierre instantáneo sistema servo

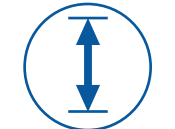

Altura regulable



Filtro de agua incorporado



Fácil y rápida instalación



Llenado rápido y silencioso



2 en 1

¡IMPORTANTE!
Para un correcto funcionamiento, el filtro debe estar instalado. Retirar **SOLO** para limpieza y mantenimiento

LATERAL

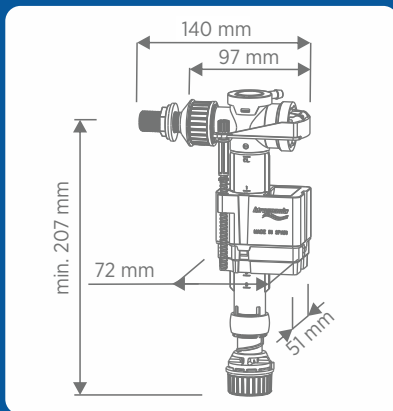

2 EN 1: Con diferentes montajes se configura el grifo para alimentación inferior o lateral

BOYA REGULABLE EN ALTURA

TELESCÓPICO AJUSTABLE EN ALTURA

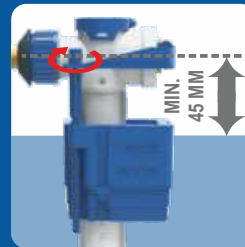
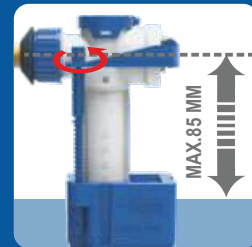

INFERIOR

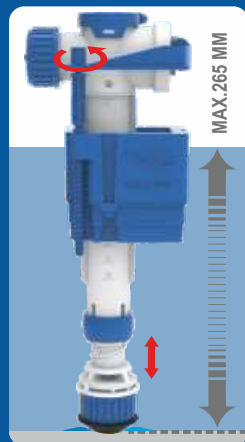
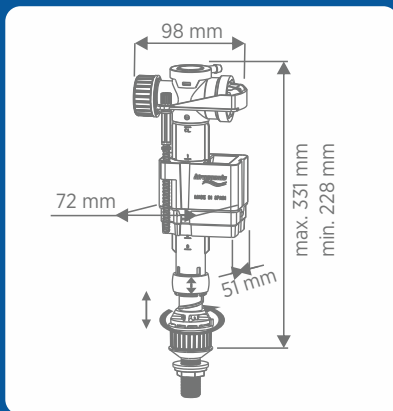

mod. DUO COMPACT GRIFOS DE ALIMENTACIÓN EQUIPAMIENTO WC

NUEVO
Diseño

- Mayor rango de regulación
- Más compacto
- Con nueva goma de cierre más silenciosa



Cierre por pistón



Altura regulable



Apto para todo tipo de agua



Filtro de agua incorporado



Fácil y rápida instalación

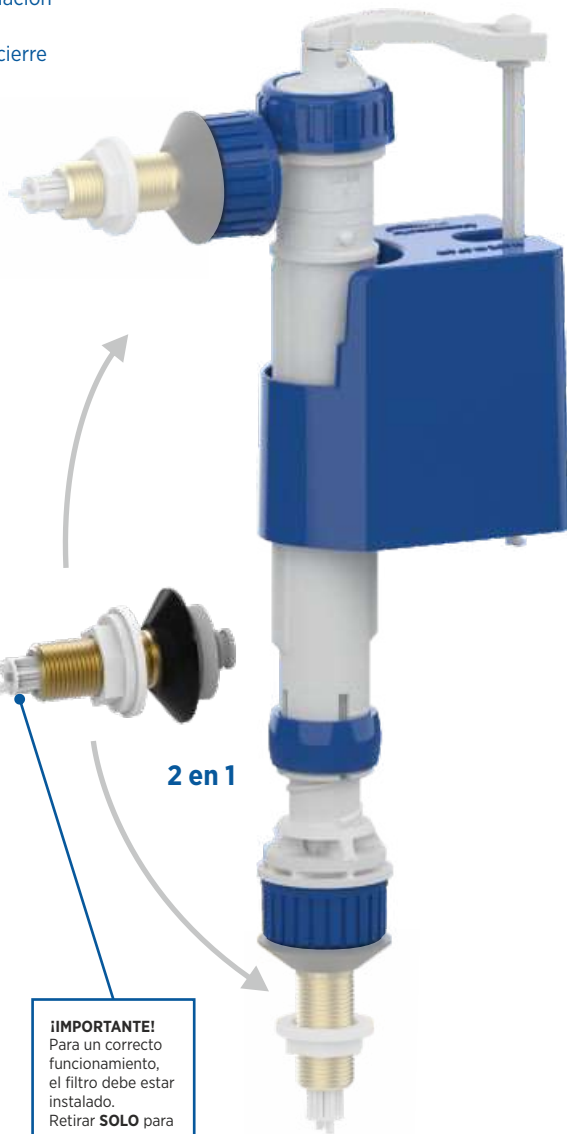

¡IMPORTANTE!
Para un correcto funcionamiento, el filtro debe estar instalado. Retirar **SOLO** para limpieza y mantenimiento

Características Técnicas:

- ▶ Presiones de trabajo desde 0,5 a 10 bar. Resiste picos de presión hasta 12 bar.
- ▶ Rápida instalación.
- ▶ Compatible con todas las cisternas cerámicas.
- ▶ Fabricado con polímeros plásticos de alta calidad y anticálceos.
- ▶ Casquillo latón 3/8" · 1/2"
- ▶ Sistema antirretorno

Grifo flotador compacto alimentación lateral o inferior cierre por pistón modelo Duo Compact

Cod.	Emb.	€		
21300	BOLSA	14,05	35	CASQUILLO LATÓN 3/8"
21301	CAJA	15,10	21	CASQUILLO LATÓN 3/8"
21301.1	BOX CAJA	15,10	84	CASQUILLO LATÓN 3/8"
21303	BOLSA	14,55	35	CASQUILLO LATÓN 1/2"

2 EN 1: Con diferentes montajes se configura el grifo para alimentación inferior o lateral

BOYA REGULABLE EN ALTURA

TELESCÓPICO AJUSTABLE EN ALTURA

LATERAL

INFERIOR

GRIFOS DE ALIMENTACIÓN EQUIPAMIENTO WC

mod. SERVO

Grifo flotador compacto
alimentación lateral modelo Servo

Cod.	Emb.	€	
20100	BOLSA	11,55	45
20101	CAJA	12,60	27

Características Técnicas:

- ▶ Presiones de trabajo desde 0,5 a 12 bar. Resiste picos de presión hasta 16 bar.
- ▶ Rápida instalación.
- ▶ Compatible con todas las cisternas cerámicas.
- ▶ Fabricado con polímeros plásticos de alta calidad y anticálceos.
- ▶ Casquillo latón 3/8"
- ▶ Sistema antirretorno



¡IMPORTANTE!
Para un correcto funcionamiento, el filtro debe estar instalado. Retirar **SOLO** para limpieza y mantenimiento



Cierre instantáneo sistema servo



Filtro de agua incorporado



Fácil y rápida instalación



Lenado rápido y silencioso

BOYA REGULABLE EN ALTURA

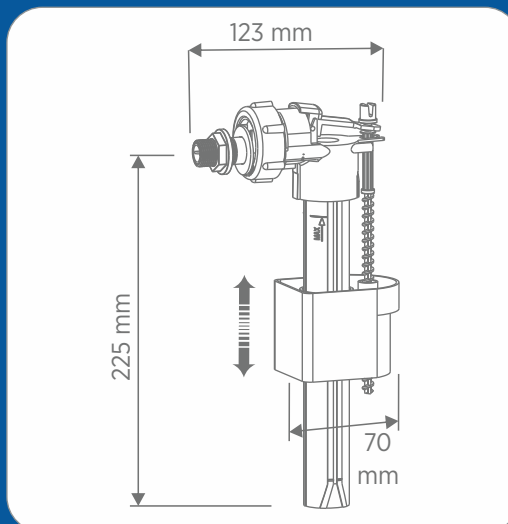
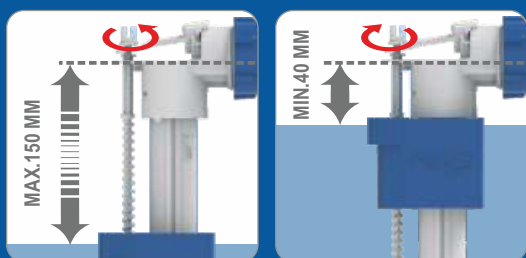

NUEVO
Diseño

- Mayor rango de regulación
- Más compacto
- Con nueva goma de cierre más silenciosa

¡IMPORTANTE!
Para un correcto funcionamiento, el filtro debe estar instalado.
Retirar **SOLO** para limpieza y mantenimiento



Cierre por pistón



Apto para todo tipo de agua



Filtro de agua incorporado



Fácil y rápida instalación

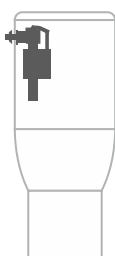

Características Técnicas:

- ▶ Presiones de trabajo desde 0,5 a 10 bar. Resiste picos de presión hasta 12 bar.
- ▶ Rápida instalación.
- ▶ Compatible con todas las cisternas cerámicas.
- ▶ Fabricado con polímeros plásticos de alta calidad y anticálceos.
- ▶ Casquillo latón 3/8" · 1/2"
- ▶ Sistema antirretorno

Grifo flotador compacto alimentación lateral cierre por pistón modelo Compact

Cod.	Emb.	€		
20800	BOLSA	11,25	35	CASQUILLO LATÓN 3/8"
20801	CAJA	12,35	27	CASQUILLO LATÓN 3/8"
20803	BOLSA	11,85	35	CASQUILLO LATÓN 1/2"

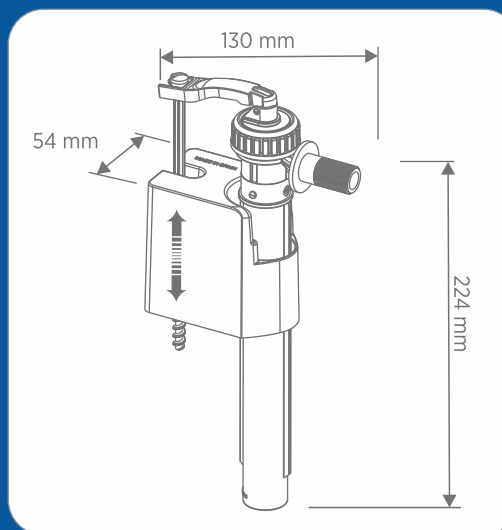

BOYA REGULABLE EN ALTURA

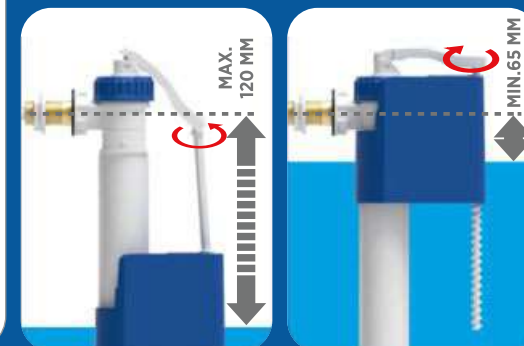

GRIFOS DE ALIMENTACIÓN EQUIPAMIENTO WC

mod. SERVO SUPER COMPACT

Grifo telescópico Servo
alimentación inferior modelo
Servo Super Compact

Cod.	Emb.	€	
21400	BOLSA	14,50	50
21401	CAJA	15,55	24

Características Técnicas:

- ▶ Presiones de trabajo desde 0,2 a 16 bar.
- ▶ Rápida instalación.
- ▶ Compatible con todas las cisternas cerámicas.
- ▶ Fabricado con polímeros plásticos de alta calidad y anticalcáreos.
- ▶ Casquillo latón 3/8"
- ▶ Sistema antirretorno

Seguro de regulación en la parte superior

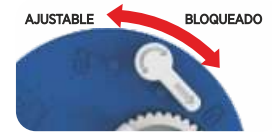

Filtro incorporado en el cabezal que facilita su mantenimiento



Cierre instantáneo sistema servo

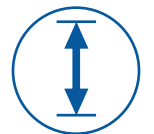

Altura regulable



Filtro de agua incorporado



Fácil y rápida instalación



Llenado rápido y silencioso



TELESCÓPICO AJUSTABLE EN ALTURA

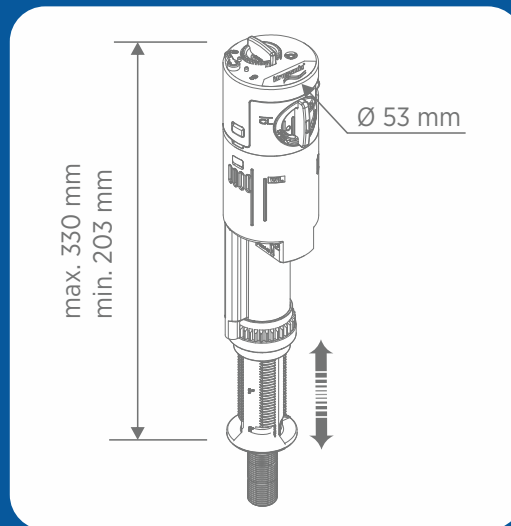



Cierre instantáneo sistema servo

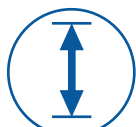

Altura regulable



Filtro de agua incorporado



Fácil y rápida instalación



Llenado rápido y silencioso

¡IMPORTANTE!
Para un correcto funcionamiento, el filtro debe estar instalado. Retirar **SOLO** para limpieza y mantenimiento

Características Técnicas:

- ▶ Presiones de trabajo desde 0,5 a 12 bar. Resiste picos de presión hasta 16 bar.
- ▶ Rápida instalación.
- ▶ Compatible con todas las cisternas cerámicas.
- ▶ Fabricado con polímeros plásticos de alta calidad y anticálceos.
- ▶ Casquillo latón 3/8" · 1/2"
- ▶ Sistema antirretorno

Grifo flotador compacto alimentación inferior telescópico modelo Servo

Cod.	Emb.	€		
20200	BOLSA	11,85	50	CASQUILLO LATÓN 3/8"
20201	CAJA	13,05	27	CASQUILLO LATÓN 3/8"
20203	BOLSA	12,40	50	CASQUILLO LATÓN 1/2"



TELESCÓPICO AJUSTABLE EN ALTURA



GRIFOS DE ALIMENTACIÓN EQUIPAMIENTO WC

mod. COMPACT

Grifo flotador telescópico compacto alimentación inferior cierre por pistón modelo Compact

	Cod.	Emb.	€	
CASQUILLO LATÓN 3/8"	20600	BOLSA	11,25	40
CASQUILLO LATÓN 3/8"	20601	CAJA	12,35	21
CASQUILLO LATÓN 1/2"	20603	BOLSA	11,85	40

Características Técnicas:

- ▶ Presiones de trabajo desde 0,5 a 10 bar. Resiste picos de presión hasta 12 bar.
- ▶ Rápida instalación.
- ▶ Compatible con todas las cisternas cerámicas.
- ▶ Fabricado con polímeros plásticos de alta calidad y anticalcáreos.
- ▶ Casquillo latón 3/8" · 1/2"
- ▶ Sistema antirretorno



NUEVO
Diseño

- Mayor rango de regulación
- Más compacto
- Con nueva goma de cierre más silenciosa



Cierre por pistón

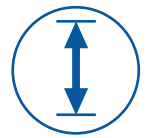

Altura regulable



Apto para todo tipo de agua



Filtro de agua incorporado



Fácil y rápida instalación

¡IMPORTANTE!
Para un correcto funcionamiento, el filtro debe estar instalado. Retirar **SOLO** para limpieza y mantenimiento

TELESCÓPICO AJUSTABLE EN ALTURA

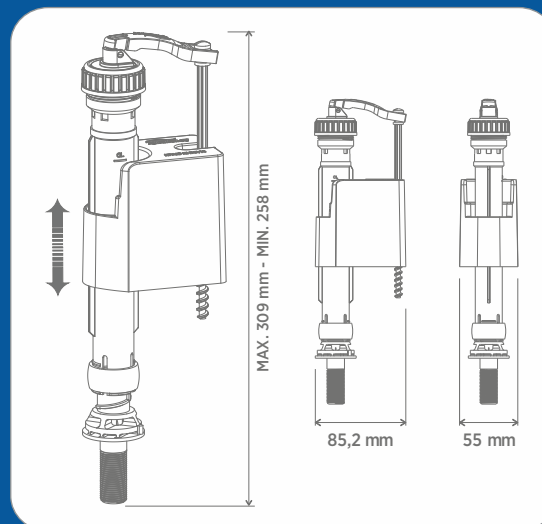
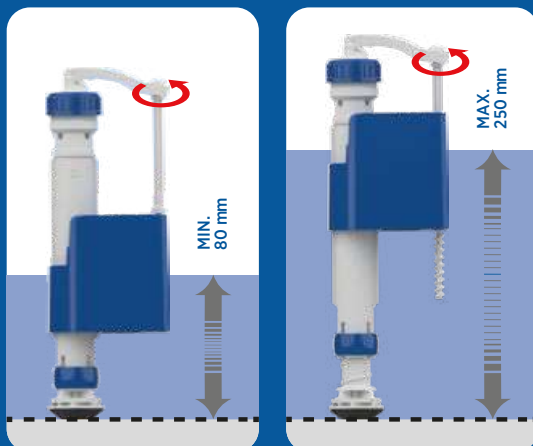



Apto para todo tipo de agua



Fácil y rápida instalación



Apto para todo tipo de agua



Fácil y rápida instalación

Cod.		€	
------	--	---	--

20300

Grifo alimentación lateral con BOYA SOPLADO.
Modelo Lina
-Casquillo latón 3/8"
-Varilla latón
-Tornillo regulación latón

6,50

65

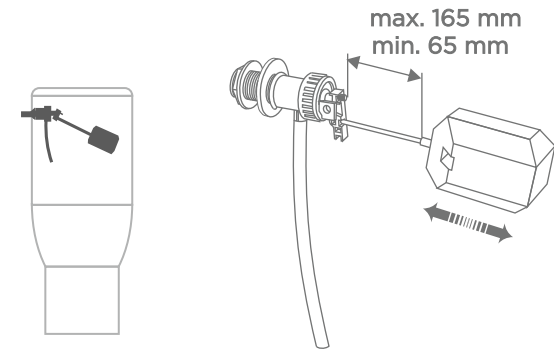

Cod.		€	
------	--	---	--

20301

Grifo alimentación lateral con BOYA ESPUMA.
Modelo Lina
-Casquillo latón 3/8"
-Varilla latón
-Tornillo regulación latón

6,80

60

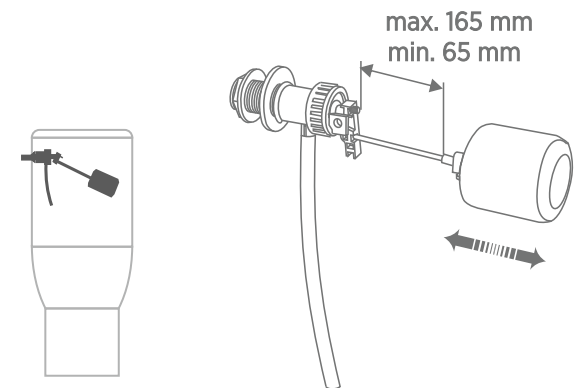

GRIFOS DE ALIMENTACIÓN EQUIPAMIENTO WC

mod. Ana

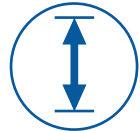

Altura regulable



Apto para todo tipo de agua



Fácil y rápida instalación

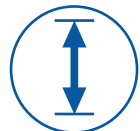

Altura regulable



Apto para todo tipo de agua



Fácil y rápida instalación

Cod.

€



20400

Grifo alimentación inferior telescópico con BOYA SOPLADO.
Modelo Ana
-Casquillo latón 3/8"
-Varilla latón
-Tornillo regulación latón

9,10

55

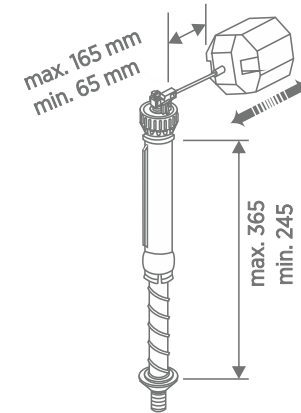
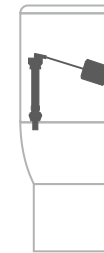

Cod.

€



20401

Grifo alimentación inferior telescópico con BOYA ESPUMA.
Modelo Ana
-Casquillo latón 3/8"
-Varilla latón
-Tornillo regulación latón

9,40

45

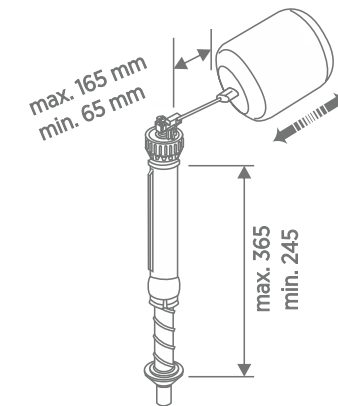





CONJUNTOS HIGIÉNICOS DUCHA-BIDET



Cod.		€	
70078	Conjunto higiénico MODELO OROPESA	139,70	-

Conjunto higiénico MODELO OROPESA, Monomando empotrado mezclador de agua fría-caliente, para sustituir el bidet.

- Compuesto por:
- Monomando con cuerpo empotrado de latón y soporte con toma
 - Ducha-bidet de latón
 - Embellecedor de latón
 - Flexible de doble grapado ACERO INOX de 1,20 m con tuercas ANTI-TWIST de latón

ACABADO CROMADO

AGUA FRÍA Y CALIENTE  

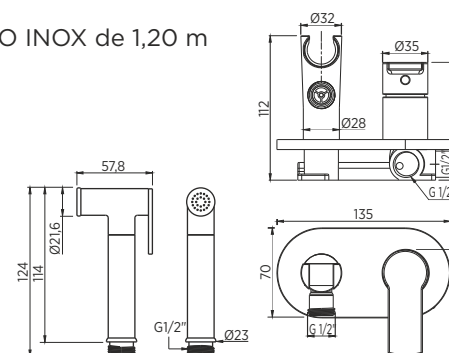

Cod.		€	
70077	Conjunto higiénico MODELO BENICASSIM	90,60	-

Conjunto higiénico MODELO BENICASSIM, Monomando empotrado mezclador de agua fría-caliente, para sustituir el bidet.

- Compuesto por:
- Monomando con cuerpo empotrado de latón
 - Soporte latón ajustable en el monomando
 - Ducha-bidet de latón
 - Embellecedor de latón
 - Flexible de doble grapado ACERO INOX de 1,20 m con tuercas ANTI-TWIST de latón

ACABADO CROMADO

AGUA FRÍA Y CALIENTE  

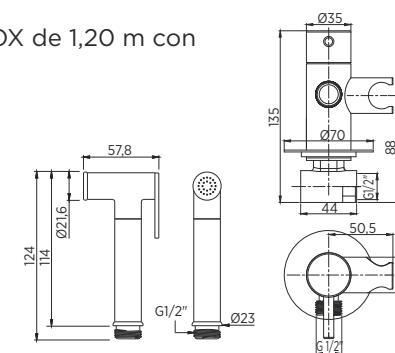

DUCHA-BIDET



Cod.		€	
70078.NE	Conjunto higiénico MODELO OROPESA	172,25	-

Conjunto higiénico MODELO OROPESA, Monomando empotrado mezclador de agua fría-caliente, para sustituir el bidet

- Compuesto por:
- Monomando con cuerpo empotrado de latón y soporte con toma
 - Ducha-bidet de latón
 - Embellecedor de latón
 - Flexible de doble grapado de 1,20m con tuercas ANTI-TWIST de latón



CIERRE SEGURIDAD

ACABADO NEGRO MATE

AGUA FRÍA Y CALIENTE  

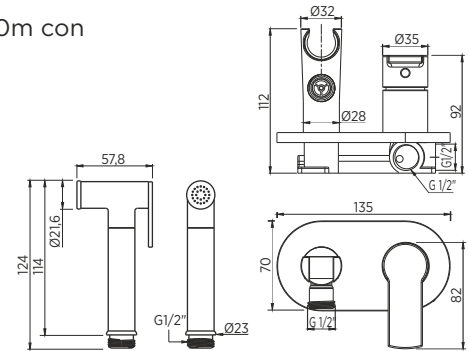

Cod.		€	
70077.NE	Conjunto higiénico MODELO BENICASSIM	117,55	-

Conjunto higiénico MODELO BENICASSIM, Monomando empotrado mezclador de agua fría-caliente, para sustituir el bidet

- Compuesto por:
- Monomando con cuerpo empotrado de latón
 - Soporte latón ajustable en el monomando
 - Ducha-bidet de latón
 - Embellecedor de latón
 - Flexible de PVC de 1,20m con tuercas ANTI-TWIST de latón

ACABADO NEGRO MATE

AGUA FRÍA Y CALIENTE  

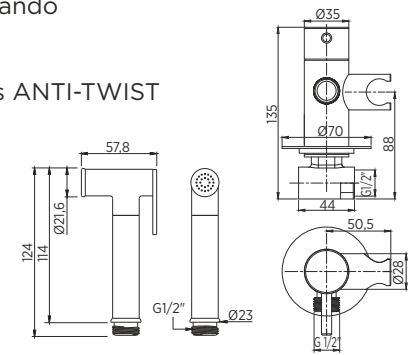

PRODUCTO NUEVO

easy BOX



Cod. €

70110 Conjunto higiénico MODELO BENICASSIM **EASY BOX**

94,90 -

Conjunto higiénico MODELO BENICASSIM **EASY BOX**,
 Monomando empotrado mezclador de agua fría-caliente, para sustituir el bidet.
 Sistema Antirretorno

- Compuesto por:
- Monomando con cuerpo empotrado de latón
 - Soporte latón ajustable en el monomando
 - Ducha-bidet de latón
 - Embellecedor de latón
 - Flexible de doble grapado ACERO INOX de 1,20m con tuercas ANTI-TWIST de latón
 - Caja **EASY BOX** naranja fácil de instalar

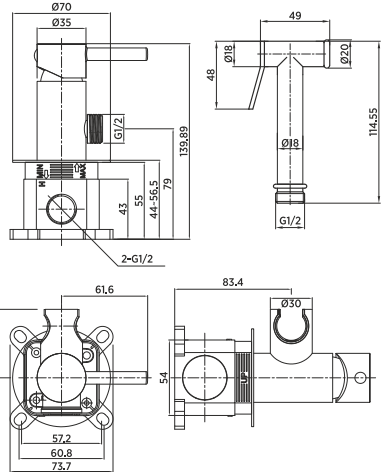

ACABADO CROMADO

AGUA FRÍA Y CALIENTE

Cod. €

70078.ECO Conjunto higiénico MODELO OROPESA **ECO**

90,85 -

Conjunto higiénico MODELO OROPESA **ECO**,
 Monomando empotrado mezclador de agua fría-caliente, para sustituir el bidet.

- Compuesto por:
- Monomando con cuerpo empotrado de latón y soporte con toma
 - Ducha-bidet de latón
 - Embellecedor de latón
 - Flexible de doble grapado ACERO INOX de 1,20 m con tuercas ANTI-TWIST de latón

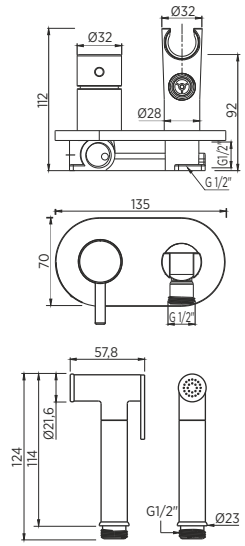

ACABADO CROMADO

AGUA FRÍA Y CALIENTE

DUCHA-BIDET



Cod.		€	
70074	Conjunto higiénico de un agua ducha-bidet con flexible doble grapado ACERO INOX. ANTI-TWIST	30,40	-

- Compuesto por:
- Ducha-bidet latón
 - Soporte ABS
 - Flexible 1,2 m con tuerca de latón

ACABADO CROMADO

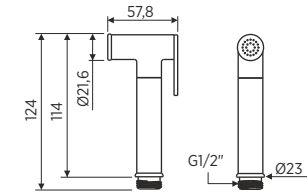

Cod.		€	
70076	Conjunto higiénico de un agua ducha-bidet con flexible doble grapado ACERO INOX. ANTI-TWIST	43,10	-

- Compuesto por:
- Ducha-bidet latón
 - Llave de escuadra latón con soporte
 - Embellecedor ACERO INOX Ø50
 - Flexible 1,2 m con tuerca de latón

ACABADO CROMADO



Llave con soporte incorporado y sistema de cierre automático del suministro de agua al colgar la ducha en el soporte.



Cod.		€	
------	--	---	--

70072 Conjunto higiénico de un agua ducha-bidet con flexible doble grapado ACERO INOX. ANTI-TWIST 45,40 -

- Compuesto por:
- Ducha-bidet latón
 - Soporte ABS
 - Llave de escuadra latón doble salida
 - Embellecedor ACERO INOX Ø50
 - Flexible 1,2 m con tuerca de latón

*No incluye latiguillo a cisterna de inodoro

ACABADO CROMADO



Permite cerrar de una forma independiente el agua a la ducha y al tanque del inodoro.

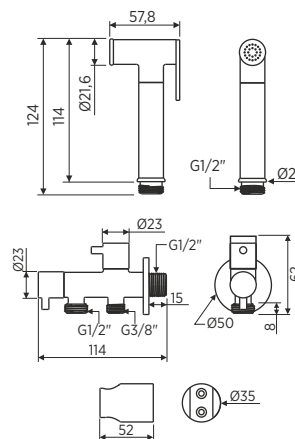

Cod.		€	
------	--	---	--

70071.NE Conjunto higiénico de un agua ducha-bidet con flexible PVC negro mate 86,65 -

- Compuesto por:
- Ducha-bidet latón
 - Soporte latón
 - Llave de escuadra latón doble salida
 - Embellecedor latón Ø50
 - Flexible de PVC de 1,20m con tuercas ANTI-TWIST de latón

*No incluye latiguillo a cisterna de inodoro

ACABADO NEGRO MATE



Permite cerrar de una forma independiente el agua a la ducha y al tanque del inodoro.

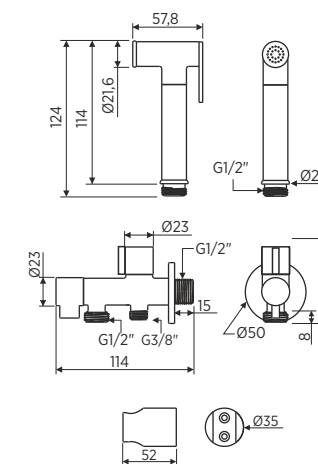

DUCHA-BIDET



CIERRE AUTOMÁTICO DE AGUA



FLUJO CONTÍNUO DE AGUA



Flexible metalizado

Flexible PVC silver grey

- Longitud 1.2 m
- Tuercas de latón cromado G1/2"
- ANTI-TWIST. Tuerca giratoria que evita torceduras del flexo



SERIE ECO

Cod.		€	
70070	Conjunto higiénico de un agua ducha-bidet ABS cromado con soporte de ABS cromado	16,05	-
70060	Conjunto higiénico de un agua ducha-bidet ABS cromado con soporte de ABS cromado y flexible PVC	18,25	-

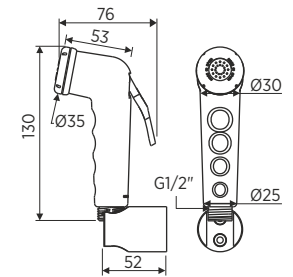

SERIE ECO

Cod.		€	
70030	Conjunto higiénico de un agua ducha-bidet ABS con soporte de ABS	7,50	-
70021	Conjunto higiénico de un agua ducha-bidet ABS con soporte de ABS y flexible PVC	10,20	-

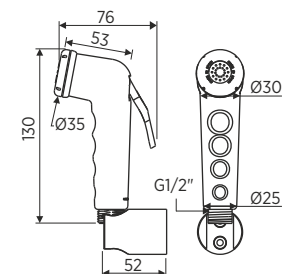

CIERRE AUTOMÁTICO DE AGUA



FLUJO CONTÍNUO DE AGUA



Flexible reforzado

Flexible PVC blanco reforzado

- Longitud 1.2 m
- Tuercas de latón cromado G1/2"
- ANTI-TWIST. Tuerca giratoria que evita torceduras del flexo



ADVERTENCIA: No dejar la ducha-bidet bajo presión continuada.

Utilice este producto correctamente, cerrando siempre la llave de paso después de su uso. Idrospania no se responsabiliza de daños debidos a un uso incorrecto.

RECAMBIOS DUCHA-BIDET



PRODUCTO
NUEVO

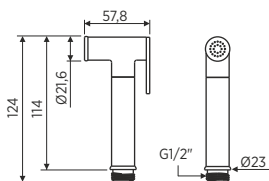

PRODUCTO
NUEVO



Cod.	€	
30425	Flexible PVC BLANCO reforzado Anti-Twist, 1,2 m con tuerca de latón cromado	1,40 -

Cod.	€	
30426	Flexible PVC SILVER GREY Anti-Twist 1,2 m con tuerca de latón cromado	8,80 -

30426.NE	Flexible PVC NEGRO MATE Anti-Twist 1,2 m con tuerca de latón cromado	12,50 -
-----------------	--	---------

Cod.	€	
30427	Flexible doble grapado ACERO INOX Anti-Twist 1,2 m con tuerca de latón cromado	8,90 -

Cod.	€	
30463	Ducha-bidet latón cromado	16,55 -

30463.NE	Ducha-bidet latón negro mate	32,45 -
-----------------	------------------------------	---------

Cod.	€	
30459	Recambio cartucho llaves de paso ducha-bidet 70077 y 70078	4,90 -

RECAMBIOS DUCHA-BIDET

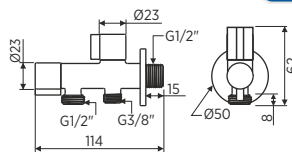
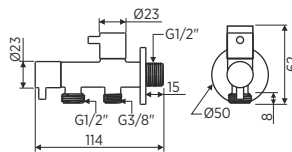

PRODUCTO
NUEVO

Cod.		€	
30460	Maneta recambio llave de paso mezcladora cromada 70077	8,00	-

30460.NE	Maneta recambio llave de paso mezcladora negro mate 70077.NE	9,10	-
-----------------	--	------	---

Cod.		€	
30461	Maneta recambio llave de paso mezcladora cromada 70078	14,95	-

30461.NE	Maneta recambio llave de paso mezcladora negro mate 70078.NE	17,20	-
-----------------	--	-------	---

Cod.		€	
30462	Maneta recambio llave de paso mezcladora cromada 70078.ECO	8,05	-

Cod.		€	
30632	Llave de escuadra doble salida latón acabado cromado	15,05	-

Cod.		€	
30632.NE	Llave de escuadra doble salida latón acabado negro mate	21,95	-





CISTERNAS COMPLETAS: SEMIALTAS, BAJAS Y TANQUE ALTO

Modelo
SUPER



ABS

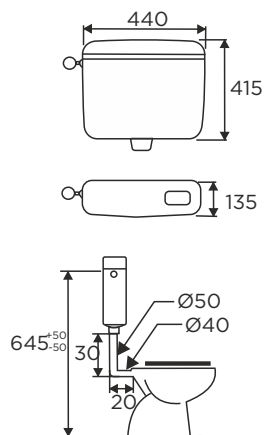

Cod.		€	
40100	Cisterna SEMIALTA completa, con interrupción de descarga equipada con grifo flotador, lateral a derechas o a izquierdas y aislamiento anticondensación y acústico	69,20	5



Modelo
SUPER-DUO



ABS

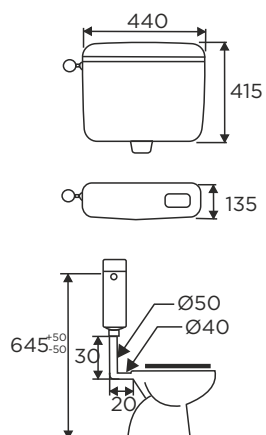

Cod.		€	
40101	Cisterna SEMIALTA completa de doble descarga equipada con grifo flotador, lateral a derechas o a izquierdas y aislamiento anticondensación y acústico	72,40	5

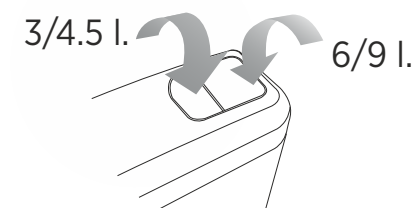

Modelo
LUX-MONOBLOCK



ABS

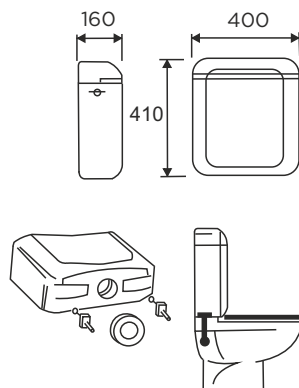

Cod.		€	
40102	Cisterna BAJA completa con interrupción de descarga equipada con grifo flotador, lateral a derechas o a izquierdas y aislamiento anticondensación y acústico	74,55	5

Sistema ajustable desde 135 hasta 280 mm

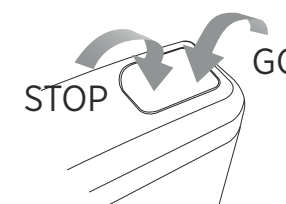
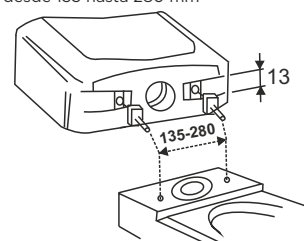

CISTERNA
EQUIPAMIENTO WC



ABS

Cod.		€	
30818	Kit convertidor a pulsador neumático para cisternas: 40100 - 40101- 40102	54,95	-



CISTERNA COMPLETA TANQUE ALTO

EQUIPAMIENTO WC

ABS



Cod.		€	
40103	Cisterna SEMIALTA - ALTA completa con tapa y CON BAJANTE	55,05	5

- Opción de alimentación por la parte izquierda o posterior
- Fácil instalación y mantenimiento.
- Incluye todos los accesorios para su instalación.
- Incluye bajante.

CUMPLE NORMATIVA UNE-EN 14055

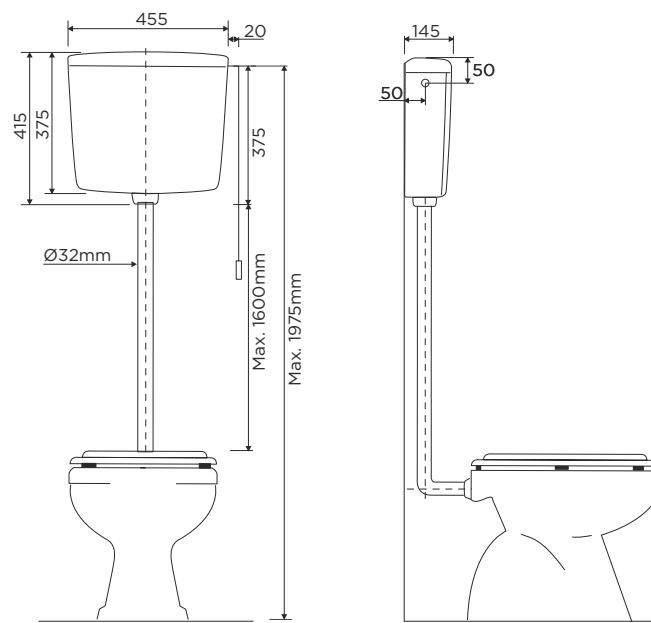

ABS

Cod.		€	
40104	Cisterna SEMIALTA - ALTA completa con tapa SIN BAJANTE	50,65	5

- Opción de alimentación por la parte izquierda o posterior
- Fácil instalación y mantenimiento

CUMPLE NORMATIVA UNE-EN 14055

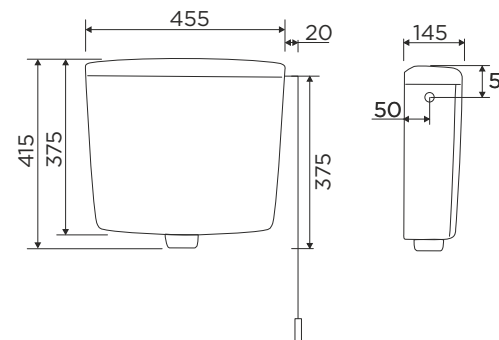



PP

Cod.		€	
40000	Cisterna completa, con grifo lateral convencional, con descargador "A" Capacidad 9 l	30,25	12

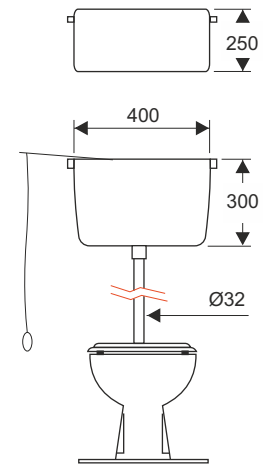



PP

Cod.		€	
40001	Casco de cisterna sin base. Capacidad 9 l	19,25	12

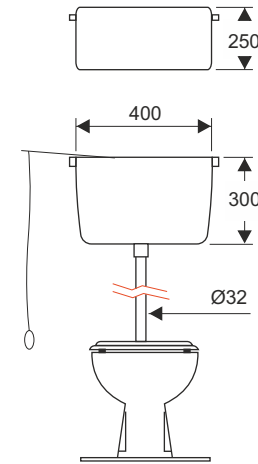

PP

Cod.		€	
40002	Casco de cisterna sin base. Capacidad 9 l	19,45	12

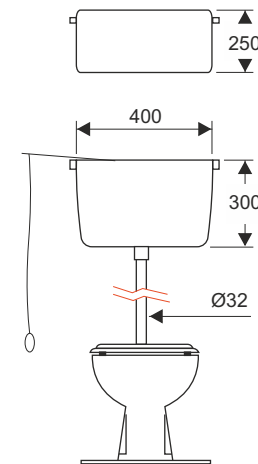



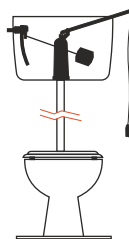

EQUIPAMIENTO TANQUE ALTO

MECANISMOS Y DESCARGADORES TANQUE ALTO EQUIPAMIENTO WC

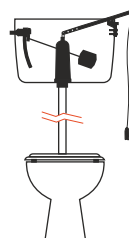

Cod.		€	
28100	Mecanismo completo, para CISTERNA ALTA DE PLÁSTICO con grifo lateral convencional, con descargador "A", con base	15,65	25



Cod.		€	
28101	Mecanismo completo, para CISTERNA ALTA DE PORCELANA, con grifo lateral convencional, con descargador "A"	17,35	25

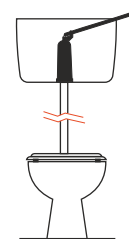

Cod.		€	
28001	Descargador "A" sin base, con soporte y palanca	6,25	60

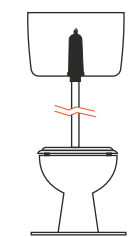

Cod.		€	
28002	Descargador "A", con base	6,95	50

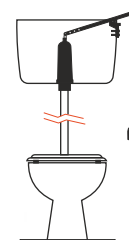

Cod.		€	
28003	Descargador "A" con base, con soporte, palanca, tornillos y cadena	10,65	40



ASIENTOS DE
INODORO



Cod.		Emb.	€	
30701	Asiento de inodoro de PP	CAJA	33,10	6
		BOX	33,10	18



30701.1

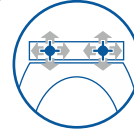

Universal corredera



IDROSPANIA
Mod. 30701
Compatible mod.
VICTORIA® de Roca®
y similares



Fabricado en PP

- Peso: 1700 g
- Color: blanco

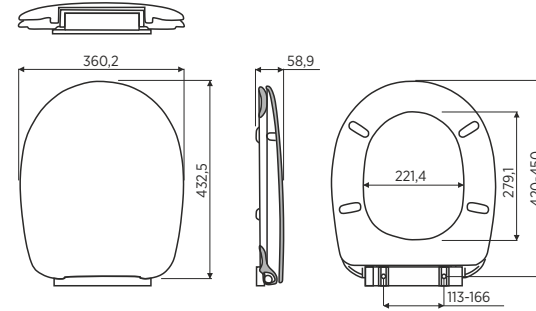

Cod.		Emb.	€	
30702	Asiento de inodoro de PP, con SOFT CLOSE	CAJA	40,90	6
		BOX	40,90	18



30702.1

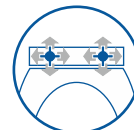

Universal corredera



Soft Close



IDROSPANIA
Mod. 30702
Compatible mod.
VICTORIA® de Roca®
y similares



Fabricado en PP

- Peso: 1700 g
- Color: blanco

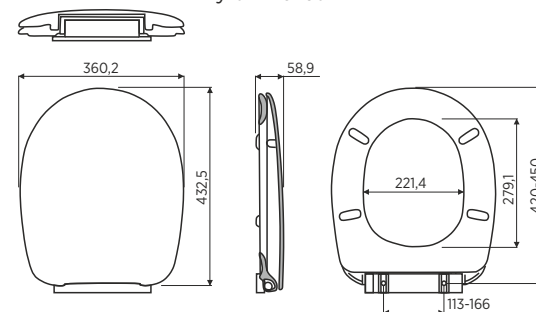

* Las denominaciones son marcas registradas por compañías no relacionadas con H&H IDROSPANIA TECHNIC S.L.

ASIENTOS DE INODORO

EQUIPAMIENTO WC



Cod.		Emb.	€	
30703	Asiento de inodoro de DUROPLAST con QUICK RELEASE	CAJA	47,15	6
30703.1		BOX	47,15	18



Quick Release

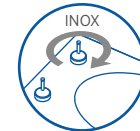

Herrajes ACERO INOX 360°



Fabricado en DUROPLAST



IDROSPANIA
Mod. 30703
Compatible mod. VICTORIA® de Roca® y similares

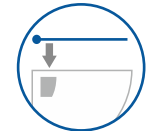

Fijación superior

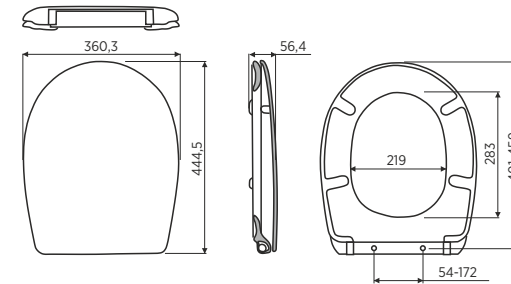

- Peso: 2200 g
- Color: blanco

Cod.		Emb.	€	
30709	Asiento de inodoro SLIM de DUROPLAST con SOFT CLOSE	CAJA	61,90	6
30709.1		BOX	61,90	18



Quick Release



Herrajes ACERO INOX 360°



Slim

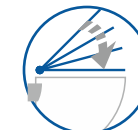

Soft Close



Fabricado en DUROPLAST



IDROSPANIA
Mod. 30709
Compatible mod. VICTORIA® de Roca® y similares



Fijación superior

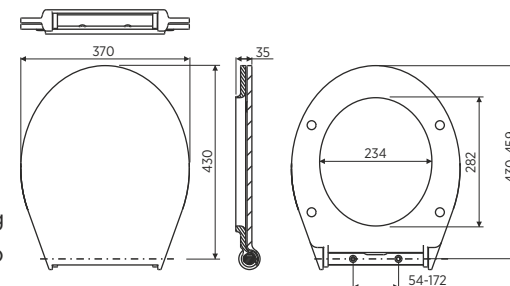

- Peso: 2600 g
- Color: blanco

* Las denominaciones son marcas registradas por compañías no relacionadas con H&H IDROSPANIA TECHNIC S.L.

ASIENTOS DE INODORO EQUIPAMIENTO WC



Cod.		Emb.	€	
30710	Asiento de inodoro de DUROPLAST, con SOFT CLOSE	CAJA	54,10	6
30710.1		BOX	54,10	18



Quick Release

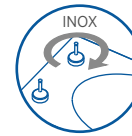

Herrajes ACERO INOX 360°



Soft Close



Fabricado en DUROPLAST



IDROSPANIA
Mod. 30710
Compatible mod. Gap® de Roca®

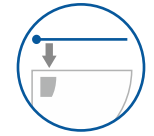

Fijación superior

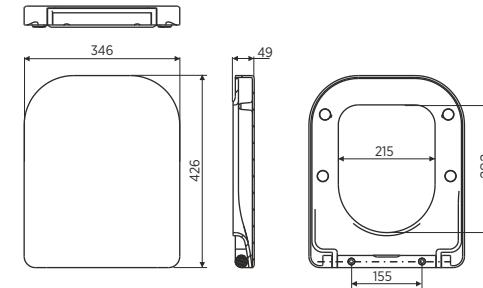

- Peso: 2300 g
- Color: blanco

Cod.		Emb.	€	
30711	Asiento de inodoro SLIM de DUROPLAST con SOFT CLOSE	CAJA	54,10	6
30711.1		BOX	54,10	18



Herrajes ACERO INOX 360°

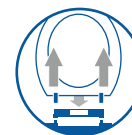

Quick Release



Soft Close



Slim



IDROSPANIA
Mod. 30711
Compatible mod. Meridian® de Roca®

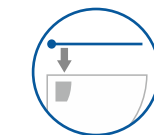

Fijación superior



Fabricado en DUROPLAST

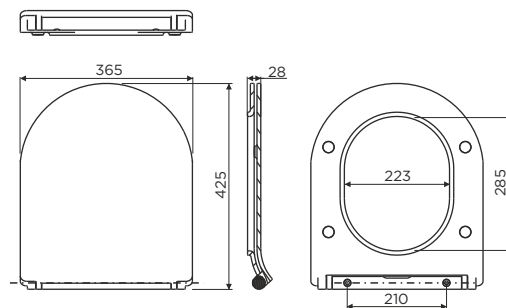

- Peso: 2600 g
- Color: blanco

* Las denominaciones son marcas registradas por compañías no relacionadas con H&H IDROSPANIA TECHNIC S.L.

ASIENTOS DE INODORO

EQUIPAMIENTO WC

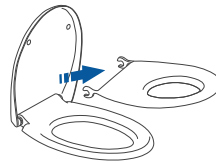

Soft Close



Quick Release



Fabricado en DUROPLAST



Family

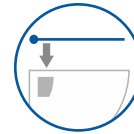

Fijación superior

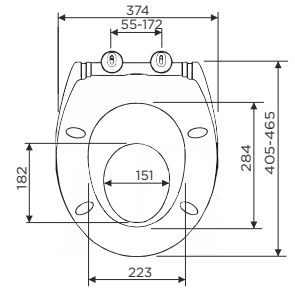

- Peso: 2900 g
- Color: blanco

Cod.		€	
30715	Asiento WC family soft close	73,45	5

Cod.		€	
30716	Asiento WC elevado soft close	89,20	2



Soft Close



Fabricado en DUROPLAST

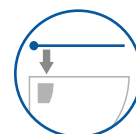

Fijación superior

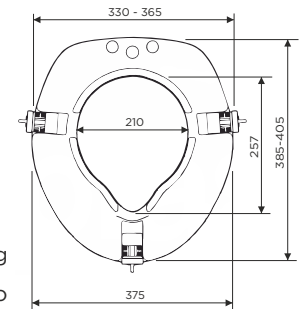

- Peso: 3500 g
- Color: blanco

Cod.		€	
30700	Asiento de inodoro PP UNIVERSAL ECO	16,40	12

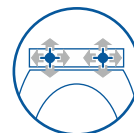

Universal corredera



IDROSPANIA
Mod. 30700
Compatible mod.
VICTORIA® de Roca®
y similares



Fabricado en PP

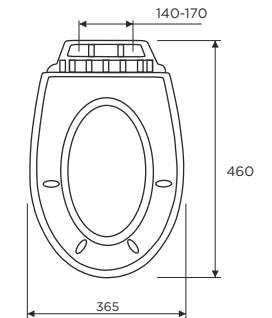

- Peso: 900 g
- Color: blanco

* Las denominaciones son marcas registradas por compañías no relacionadas con H&H IDROSPANIA TECHNIC S.L.

RECAMBIOS DE ASIENTOS EQUIPAMIENTO WC



PRODUCTO
NUEVO

PRODUCTO
NUEVO

PRODUCTO
NUEVO

Cod.		€
30705	Kit fijación, herraje nylon ajustable para asientos cod.30701 y cod.30702	3,60
30707	Juego topes asiento inodoro PP para cod.30701 y cod.30702	2,35
30706	Kit fijación, herraje universal INOX presión, quick release para asiento cod.30703 y cod.30709	14,95
30712	Kit fijación, herraje universal INOX presión, quick release para asiento cod.30710 y cod.30711	11,45
30708	Juego topes asiento inodoro duroplast para cod.30703	2,35
30713	Juego topes asiento inodoro duroplast para cod.30710	2,25
30714	Juego topes asiento inodoro duroplast para cod.30711	2,25
30719	Anclajes fijación tapa WC Family cod.30715	13,80
30720	Kit de 3 uds. de anclajes fijación tapa WC elevada cod.30716	13,80



ASIENTOS DE
DUCHA



Cod.		€	
30717	Asiento de ducha plegable con respaldo	57,00	5

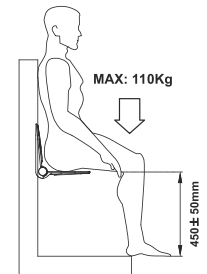

CERTIFICADOS:
 EN 12520: 2010
 EN 1728: 2000
 EN 1022: 2005
 LGA-33 064.01

- Peso: 2380 g
- Color: blanco

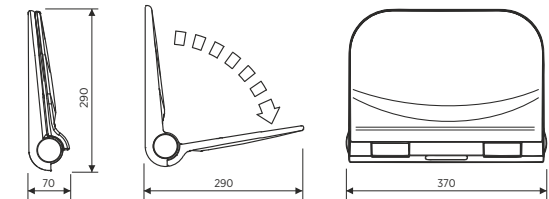

Cod.		€	
30718	Asiento de ducha plegable	104,40	5

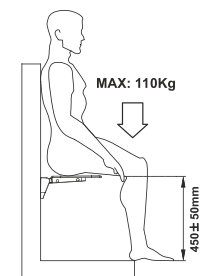

CERTIFICADOS:
 EN 12520: 2010
 EN 1728: 2000
 EN 1022: 2005

- Peso: 2540 g
- Color: blanco-cromo

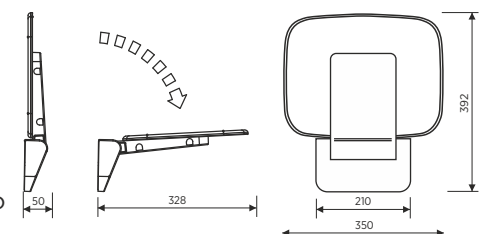



MANGUITOS
DE INODORO

MANGUITOS EQUIPAMIENTO WC

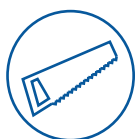
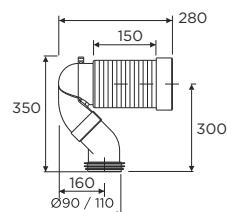
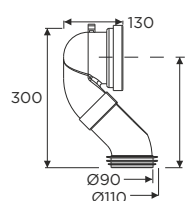
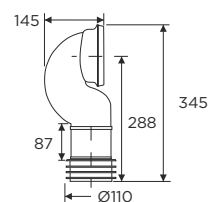
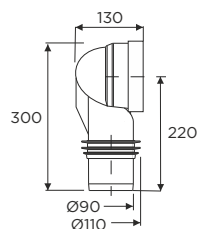

RECORTABLE

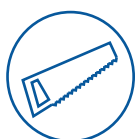
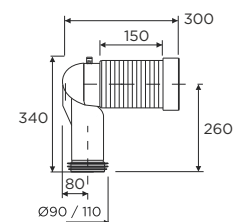

RECORTABLE

PRODUCTO
NUEVO

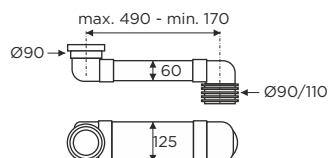

Mat.	Cod.		€	
PP	30510	Manguito conexión inodoro acodado 90° con goma labiada Ø110 mm	15,05	10
PP	30523	Manguito conexión inodoro acodado 90° con goma labiada Ø110 mm	14,60	10
PP	30514	Manguito conexión inodoro acodado 45° con goma labiada Ø110 mm	13,95	10
PVC	30529	Manguito acodado 45° recortable excentrico, con goma labiada Ø90-110 mm	22,70	5
PVC	30530	Manguito acodado 90° recortable con goma labiada Ø90-110 mm	22,10	5
PVC	30526	Manguito horizontal conexión ajustable 490-170mm	34,10	10
	30011	Conjunto fijación manguito dual	4,10	-

MANGUITOS EQUIPAMIENTO WC

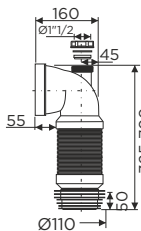
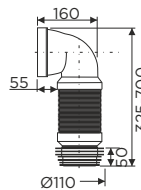
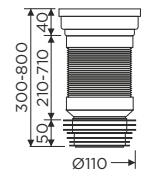
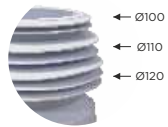
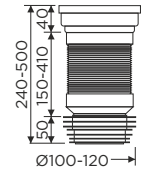
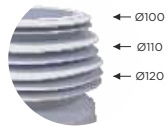
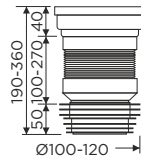

**PRODUCTO
NUEVO**

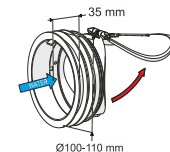

Mat.	Cod.		€	
PP	30521	Manguito conexión inodoro extensible 190-360 mm MINI con goma labiada Ø100,Ø110,Ø120 mm	15,65	15

Mat.	Cod.		€	
PP	30524	Manguito conexión inodoro extensible 240-500 mm con goma labiada Ø100,Ø110,Ø120 mm	16,15	15

Mat.	Cod.		€	
PP	30527	Manguito conexión inodoro extensible 300-800 mm con goma labiada Ø110 mm	17,10	10

Mat.	Cod.		€	
PP	30511	Manguito conexión inodoro extensible 240-480 mm con goma labiada Ø110-120 mm	11,85	15

Mat.	Cod.		€	
PP	30513	Manguito conexión inodoro extensible acodado 90° con goma labiada Ø110mm	20,50	10

Mat.	Cod.		€	
PP	30522	Manguito conexión inodoro extensible acodado 90° con toma 1"1/2 - 40 mm y goma labiada Ø110 mm	20,30	10

Mat.	Cod.		€	
PP CAUCHO	30531	Válvula anti-retorno para conexión de inodoros. Evita malos olores y entrada de insectos/ roedores	9,95	10

MANGUITOS EQUIPAMIENTO WC

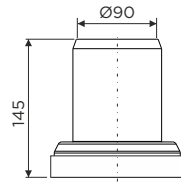

Mat.	Cod.		€	
PVC	30500	Manguito conexión inodoro recto, Ø90 mm	5,20	36

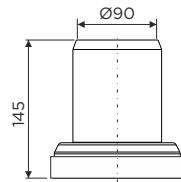

Mat.	Cod.		€	
PP	30501	Manguito conexión inodoro recto, Ø90 mm	4,65	36

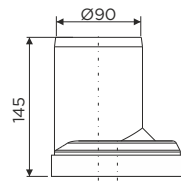

Mat.	Cod.		€	
PVC	30502	Manguito conexión inodoro excéntrico, Ø90 mm	5,20	36

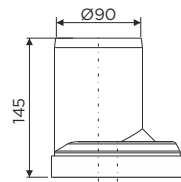

Mat.	Cod.		€	
PP	30503	Manguito conexión inodoro excéntrico, Ø90 mm	4,65	36

MANGUITOS

EQUIPAMIENTO WC

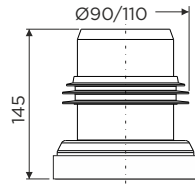

Mat.	Cod.		€	
PVC	30504	Manguito conexión inodoro recto, Ø90 mm, con goma labiada Ø110 mm	6,05	36

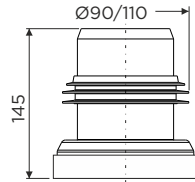

Mat.	Cod.		€	
PP	30505	Manguito conexión inodoro recto, Ø90 mm, con goma labiada Ø110 mm	5,65	36

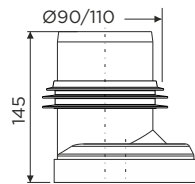

Mat.	Cod.		€	
PVC	30506	Manguito conexión inodoro excéntrico, Ø90 mm, con goma labiada Ø110 mm	6,05	36

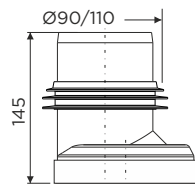

Mat.	Cod.		€	
PP	30507	Manguito conexión inodoro excéntrico, Ø90 mm, con goma labiada Ø110 mm	5,65	36

MANGUITOS EQUIPAMIENTO WC

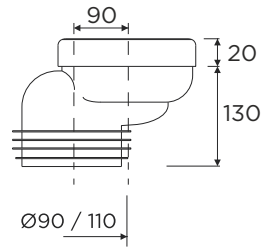

Mat.	Cod.		€	
PP	30528	Manguito super excentrico 90mm, Ø90-110 mm	10,65	18

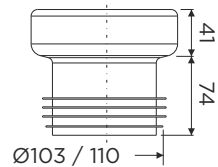

Mat.	Cod.		€	
EVA	30508	Manguito conexión inodoro recto elástico, Ø110 mm	4,35	30

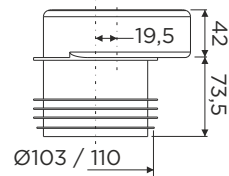

Mat.	Cod.		€	
EVA	30509	Manguito conexión inodoro excéntrico elástico, Ø110 mm	4,35	30

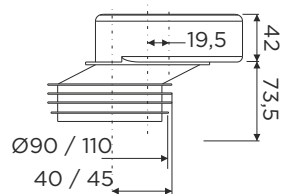

Mat.	Cod.		€	
PP	30512	Manguito elástico Superexcéntrico	5,90	22



RECAMBIOS

GOMAS TANQUE BAJO EQUIPAMIENTO WC

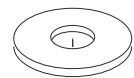

65,6x32x3mm

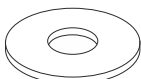

74x23x3mm



68x17x3,2mm



65x18x3mm

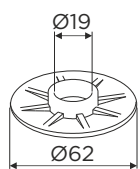
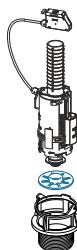
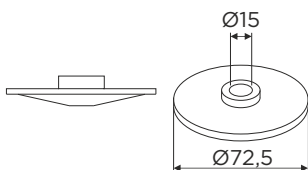

Cod.		€	Embalaje	
30210	Goma de cierre descargador T.B. Tipo Victoria	1,30	Granel	100/caja

Cod.		€	Embalaje	
30211	Goma de cierre sin cuello para descargador cisterna baja	1,25	Granel	100/caja

Cod.		€	Embalaje	
30212	Goma de cierre con cuello para descargador cisterna baja	1,25	Granel	50/caja

Cod.		€	Embalaje	
30218	Goma cierre T.B. nuevo tubo estrecho	1,20	Granel	100/caja

Cod.		€	Embalaje	
30223	Goma cierre cónica descargador universal cisterna baja	1,35	Granel	50/caja

Cod.		€	Embalaje	
30200	Goma cierre descargadores modelo Denia Plus, Denia, Loja, Javea y Palma	1,40	Granel	50/caja

GOMAS TANQUE BAJO

EQUIPAMIENTO WC

Ø110

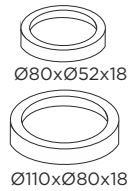
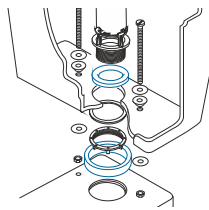

Ø110

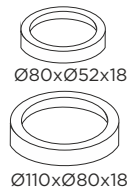
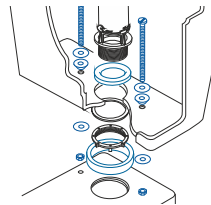

Ø110

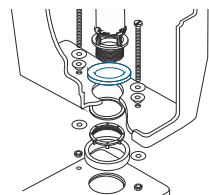
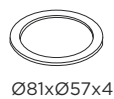
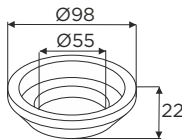
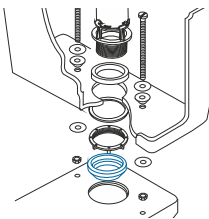

Cod.	€	Embalaje	
30231	1,65	Granel	50/bolsa

Conjunto goma asiento espuma
Øext 110 mm T.B + goma base T.B.

Cod.	€	Embalaje	
30431	3,60	Bolsa	25/bolsa

Conjunto goma asiento espuma
Øext 110 mm T.B + goma base T.B. +
tornillos HB M6x90

Cod.	€	Embalaje	
30432	4,20	Bolsa	25/bolsa

Conjunto goma asiento espuma
Øext 110 mm T.B + goma base T.B. +
tornillos INOX M6x90

Cod.	€	Embalaje	
30216	1,95	Granel	25/bolsa

Goma asiento caucho

Cod.	€	Embalaje	
30208	1,30	Granel	25/bolsa

Goma estanqueidad base rosca
tradicional

Cod.	€	Embalaje	
30209	1,20	Granel	25/bolsa

Goma base PVC T.B.

GOMAS ENCHUFE EQUIPAMIENTO WC

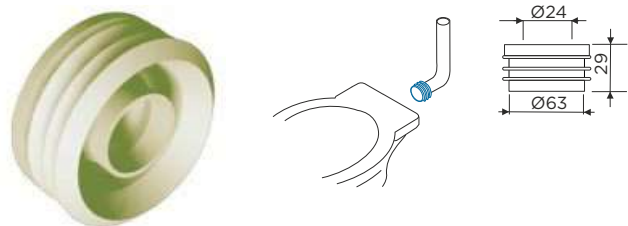

Mat.	Cod.		€	Embalaje	
75% NR 25% SBR	30213	Goma de enchufe interior inodoro	2,25	Granel	50/bolsa

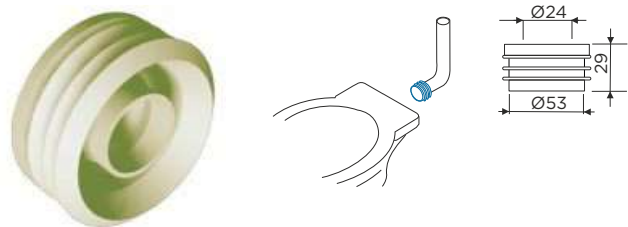

Mat.	Cod.		€	Embalaje	
75% NR 25% SBR	30234	Goma de enchufe interior inodoro	2,05	Granel	50/bolsa

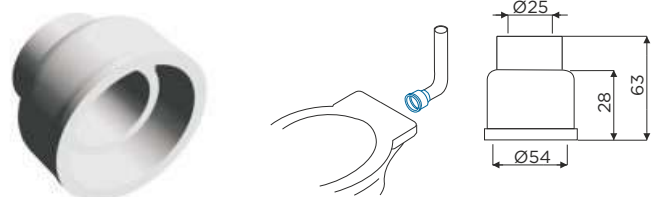

Mat.	Cod.		€	Embalaje	
75% NR 25% SBR	30214	Goma de enchufe exterior inodoro Ø25	1,90	Granel	50/bolsa

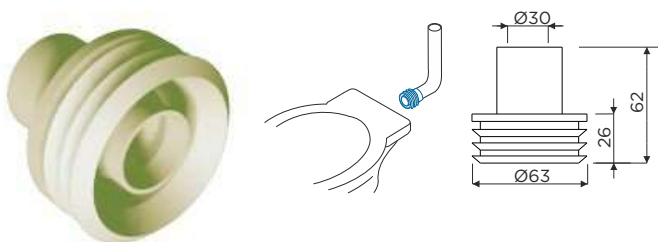

Mat.	Cod.		€	Embalaje	
75% NR 25% SBR	30219	Goma de enchufe interior inodoro con cuello Mod. Victoria	2,10	Granel	50/bolsa

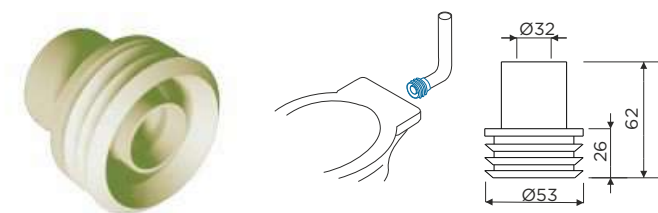

Mat.	Cod.		€	Embalaje	
75% NR 25% SBR	30220	Goma de enchufe interior inodoro con cuello Mod. Lucerna	1,95	Granel	50/bolsa



Mat.	Cod.		€	Embalaje	
75% NR 25% SBR	30222	Goma de enchufe exterior inodoro Ø30	1,75	Granel	50/bolsa

RECAMBIOS EQUIPAMIENTO WC

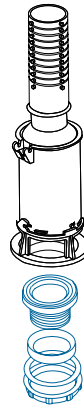

Cod.		€	Embalaje	
30104	Base rosca tradicional de tanque bajo completa	2,55	Granel	25/bolsa

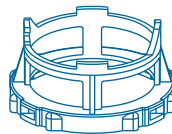

Cod.		€	Embalaje	
30109	Base descargador sistema bayoneta	1,35	Granel	25/bolsa



PRODUCTO NUEVO

Cod.		€	Embalaje	
30812	Reductor de caudal descarga RIMLESS	2,05	Granel	100/caja

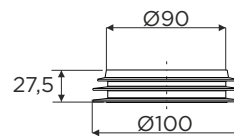
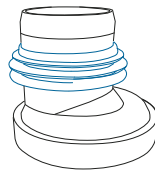

Cod.		€	Embalaje	
30221	Goma manguito interior labiada Ø 90/Ø110 mm	1,70	Granel	25/bolsa

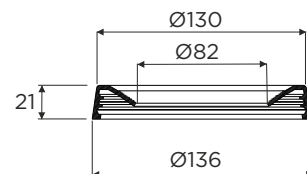
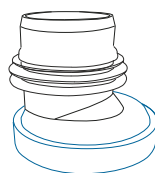

Cod.		€	Embalaje	
30226	Goma manguito conexión inodoro	3,05	Granel	25/bolsa

GOMAS FLOTADORES

EQUIPAMIENTO WC

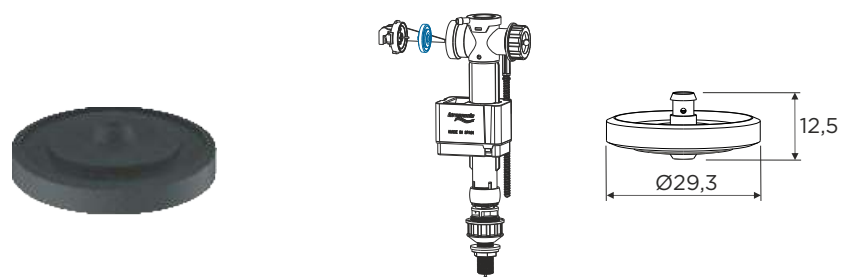

Cod.		€	Embalaje	
30230	Goma de cierre para grifos modelo "Duo"	1,80	Granel	10/bolsa

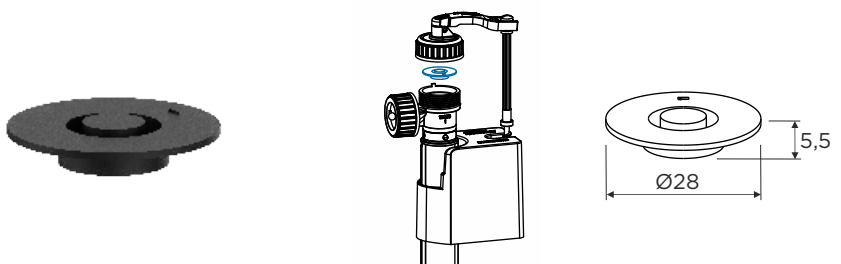

Cod.		€	Embalaje	
30237	Goma de cierre grifos compactos	0,85	Granel	10/bolsa

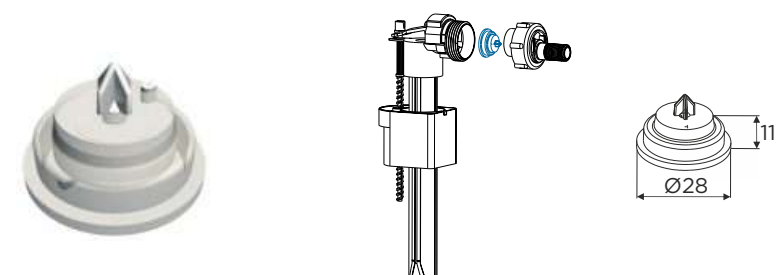

Cod.		€	Embalaje	
30201	Conjunto membrana cierre grifo lateral "Servo"	1,75	Granel	10/bolsa

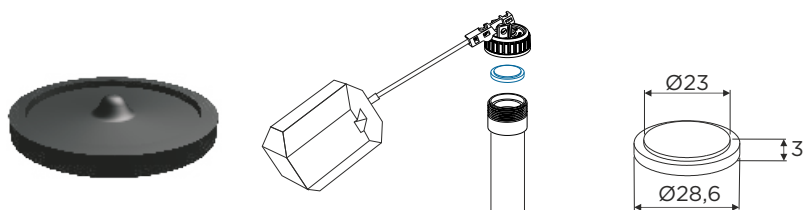

Cod.		€	Embalaje	
30202	Goma de cierre grifos Mod. "Ana" y "Lina"	0,85	Granel	25/bolsa

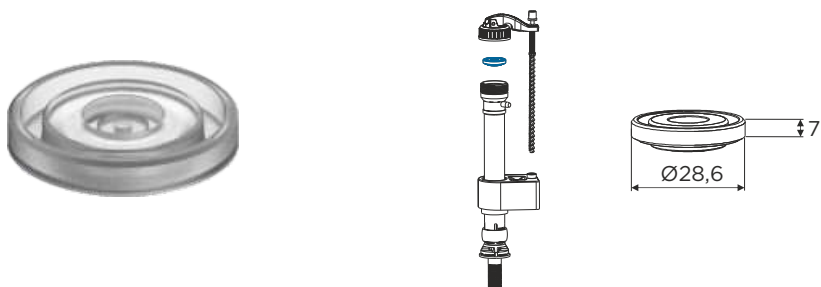

Cod.		€	Embalaje	
30204	Conjunto membrana cierre grifo inferior "Servo"	1,05	Granel	10/bolsa

RECAMBIOS TANQUE ALTO EQUIPAMIENTO WC



PVC

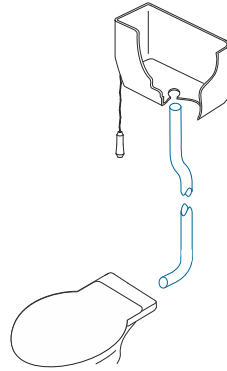

Cod.	€	Embalaje
30402	9,15	20

Bajante exterior en dos piezas
Ø32mm L=180 cm completa con
curva y codo



PRODUCTO
NUEVO

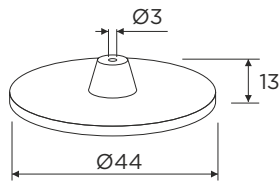

Cod.	€	Embalaje
30224	1,35	Granel 50/bolsa

Goma de cierre con cuello para
descargador cisterna alta



PRODUCTO
NUEVO

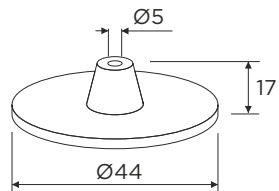

Cod.	€	Embalaje
30235	1,45	Granel 50/bolsa

Goma de cierre con cuello para
descargador cisterna alta

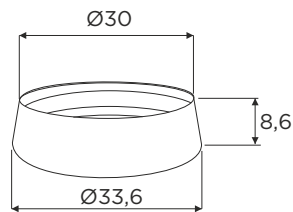

Cod.	€	Embalaje
30215	0,65	Granel 50/bolsa

Junta cónica 1"1/4x32

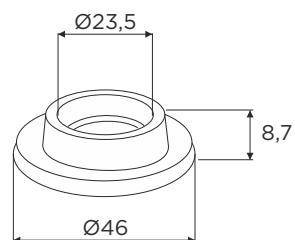
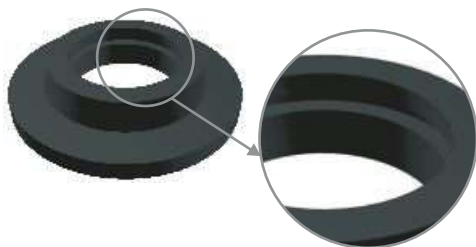

Cod.	€	Embalaje
30207	1,30	Granel 50/bolsa

Goma cierre descargador "A"

RECAMBIOS TANQUE ALTO EQUIPAMIENTO WC



Cod.		€	Embalaje	
30050	Conjunto cadena tirador cisterna alta 75cm	1,95	Bolsa	10/bolsa

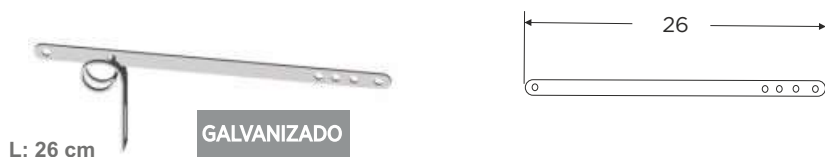

Cod.		€	Embalaje	
30051	Palanca con soporte metálico para cisterna alta	4,30	Granel	10/bolsa



Cod.		€	Embalaje	
30052	Palanca larga desc. "A" para cisterna de porcelana	2,90	Granel	10/bolsa



Cod.		€	Embalaje	
30053	Palanca corta desc. "A" para cisterna de plástico	1,75	Granel	10/bolsa

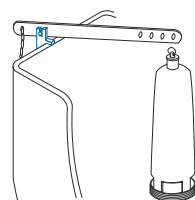

Cod.		€	Embalaje	
30101	Soporte palanca desc. "A" para cisterna de porcelana	1,60	Granel	25/bolsa

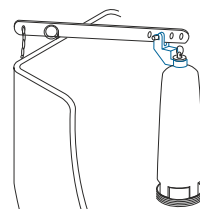

Cod.		€	Embalaje	
30102	Soporte palanca desc. "A" para cisterna alta de plástico	1,05	Granel	25/bolsa

PIEZAS DE RECAMBIO

EQUIPAMIENTO WC

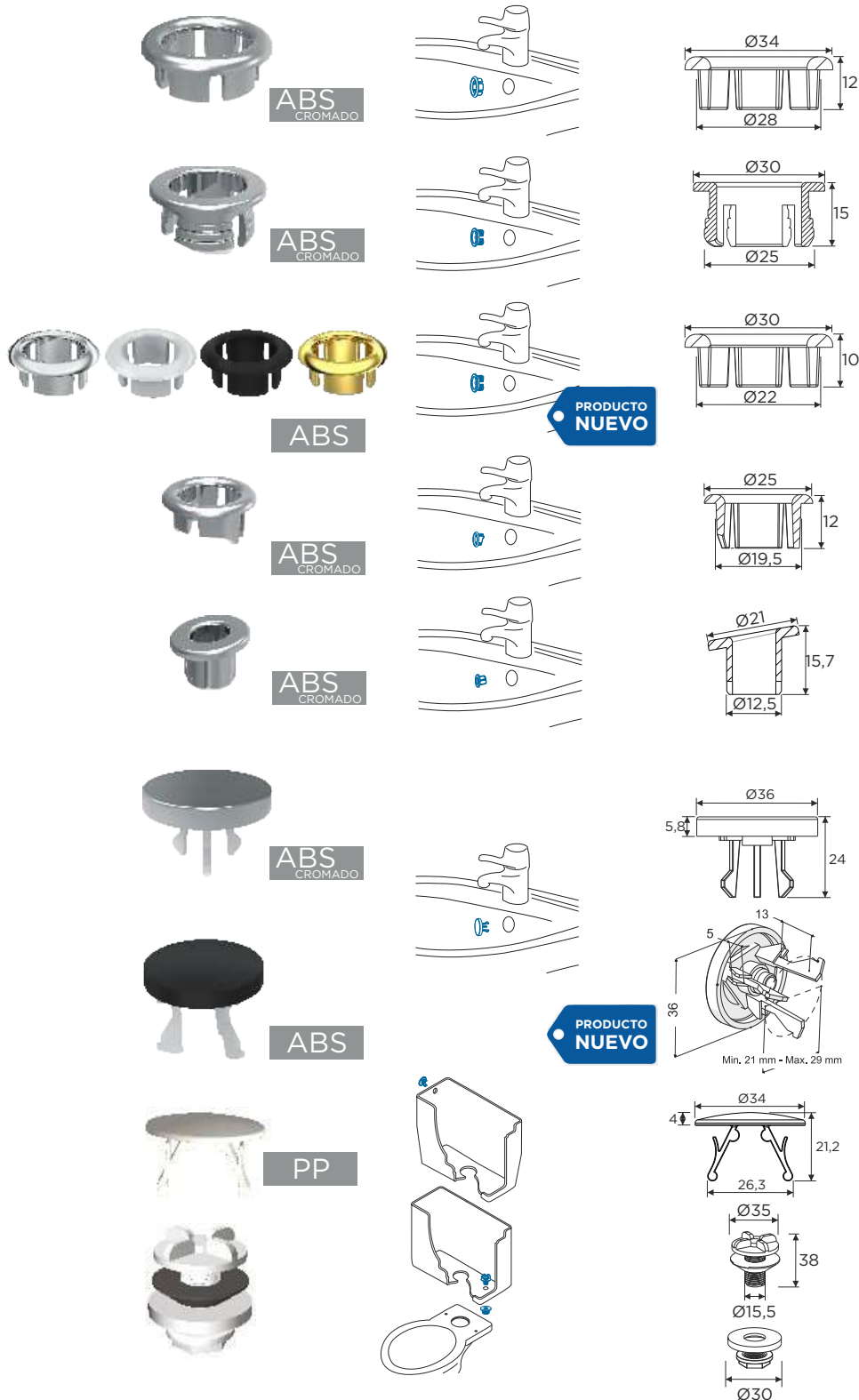

Cod.	€	Embalaje	
30617	1,20	Granel	50/bolsa

Cod.	€	Embalaje	
30618	1,20	Granel	50/bolsa

Cod.	€	Embalaje	
30653	1,35	Granel	25/bolsa
30653.BL	1,20	Granel	25/bolsa
30653.NE	1,45	Granel	25/bolsa
30653.ORO	2,10	Granel	25/bolsa

Cod.	€	Embalaje	
30619	1,15	Granel	50/bolsa

Cod.	€	Embalaje	
30620	1,15	Granel	50/bolsa

Cod.	€	Embalaje	
30621	2,40	Granel	50/bolsa

Cod.	€	Embalaje	
30621.NE	2,70	Granel	50/bolsa

Cod.	€	Embalaje	
30100	0,70	Granel	50/bolsa

Cod.	€	Embalaje	
30400	1,70	Granel	50/bolsa

RECAMBIOS, TORNILLOS EQUIPAMIENTO WC



HB

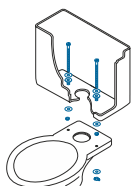

INOX

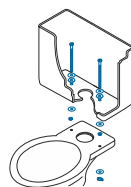

INOX

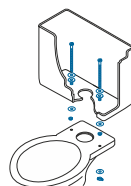

HZ

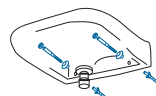

HB

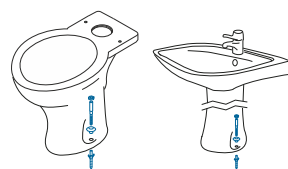

LATÓN



HB

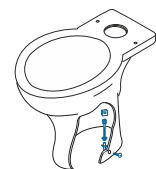

Cod.		€	Embalaje	
------	--	---	----------	--

30000	Tornillos Hierro Bicromatado taza-cisterna baja M6 x 90	1,95	Bolsa	25/bolsa
--------------	---	------	-------	----------

Cod.		€	Embalaje	
------	--	---	----------	--

30005	Tornillos INOX. taza-cisterna baja M6 x 90. Arandelas plástico	2,60	Bolsa	25/bolsa
--------------	--	------	-------	----------

Cod.		€	Embalaje	
------	--	---	----------	--

30015	Tornillos INOX. taza-cisterna baja M6 x 90. Arandelas INOX	3.50	Bolsa	25/bolsa
--------------	--	------	-------	----------

Cod.		€	Embalaje	
------	--	---	----------	--

30001	Tornillos fijación para lavabos HIERRO ZINCADO M10 x 110	2,35	Bolsa	25/bolsa
--------------	--	------	-------	----------

Cod.		€	Embalaje	
------	--	---	----------	--

30002	Tornillos verticales de Hierro Bicromatado fijación para inodoro M5 x 75	1,45	Bolsa	25/bolsa
--------------	--	------	-------	----------

Cod.		€	Embalaje	
------	--	---	----------	--

30003	Tornillos verticales de LATÓN fijación para inodoro M5 x 75	2,60	Bolsa	25/bolsa
--------------	---	------	-------	----------

Cod.		€	Embalaje	
------	--	---	----------	--

30004	Tornillos horizontales Hierro Bicromatado para inodoro M5 x 75	1,85	Bolsa	25/bolsa
--------------	--	------	-------	----------

RECAMBIOS, TORNILLOS

EQUIPAMIENTO WC



INOX

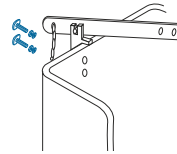

Cod.		€	Embalaje	
30006	Tornillos INOX. sujeción palanca T.A. M3/16x40	1,05	Bolsa	25/bolsa



HZ

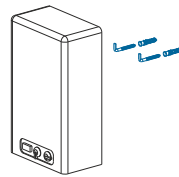

Cod.		€	Embalaje	
30007	Set de fijación alcayatas para calentadores HIERRO ZINCADO 10x75	2,10	Bolsa	25/bolsa



HZ

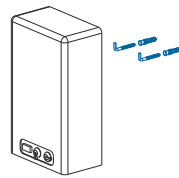

Cod.		€	Embalaje	
30009	Set de fijación alcayatas para calentadores HIERRO ZINCADO 8x65	1,80	Bolsa	25/bolsa



HZ

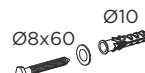
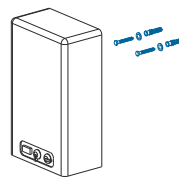

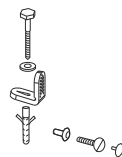
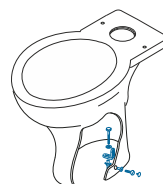

Cod.		€	Embalaje	
30010	Set de fijación tornillo hexagonal para calentadores HIERRO ZINCADO 8x60	1,30	Bolsa	25/bolsa



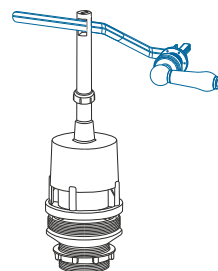
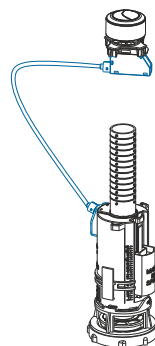
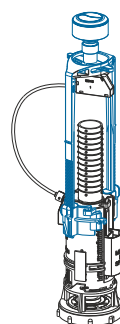
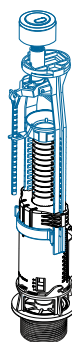

Cod.		€	Embalaje	
30616	Juego tornillos fijación inodoro con soporte nylon horizontal y tapones cromados	3,60	Bolsa	25/bolsa



Cod.		€	Embalaje	
30300	Kit fijación tapa pulsador doble descarga mod. Palma Ø16 mm / Ø40 mm	5,95	Bolsa	10/bolsa

Cod.		€	Embalaje	
30325	Kit fijación tapa pulsador doble descarga mod. Denia Plus Ø16 mm / Ø40 mm	7,40	Bolsa	10/bolsa

Cod.		€	Embalaje	
30317	Conjunto accionamiento cable descargador mod. Denia, Denia Plus y Javea Ø16 mm / Ø40 mm	4,30	Bolsa	10/bolsa

Cod.		€	Embalaje	
30323	Palanca accionamiento frontal manecilla porcelana cerámica	18,75	Bolsa	5/bolsa

RECAMBIOS PULSADORES

EQUIPAMIENTO WC

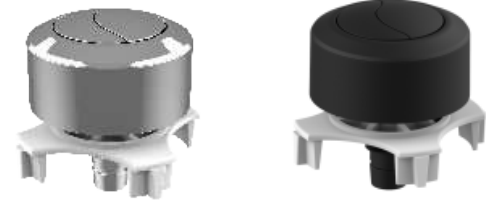

PRODUCTO
NUEVO

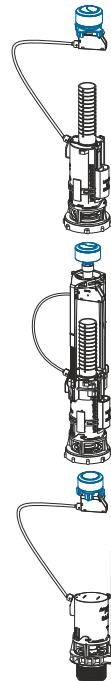
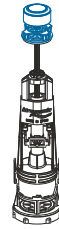
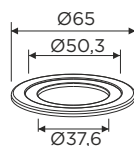
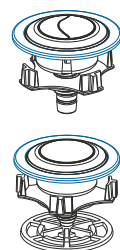

Cod.	€	Embalaje	
30310	4,00	Bolsa	25/bolsa
Conjunto pulsador cromado, descargador interrumpible Loja Ø12 mm / Ø40 mm			
30310.NE	4,50	Bolsa	25/bolsa
Conjunto pulsador negro mate, descargador interrumpible Loja Ø12 mm / Ø40 mm			
Cod.	€	Embalaje	
30314	4,00	Bolsa	25/bolsa
Conjunto pulsador doble descarga por cable, descargador Denia Ø16 mm / Ø40 mm			
30314.NE	4,50	Bolsa	25/bolsa
Conjunto pulsador negro mate doble descarga por cable, descargador Denia Ø16 mm / Ø40 mm			
Cod.	€	Embalaje	
30321	3,35	Bolsa	25/bolsa
Conjunto pulsador doble descarga por cable descargador Denia Plus Ø16 mm / Ø40 mm			
Cod.	€	Embalaje	
30315	3,45	Bolsa	25/bolsa
Conjunto pulsador descarga simple por cable descargador Javea Ø16 mm / Ø40 mm			
Cod.	€	Embalaje	
30339	4,00	Bolsa	25/bolsa
Conjunto pulsador descargador DF mod.Orcera Ø12 mm/Ø40 mm			
Cod.	€	Embalaje	
30319	1,45	Bolsa	25/bolsa
Adaptador cromado pulsadores para orificios de Ø60 mm			
30319.NE	1,55	Bolsa	25/bolsa
Adaptador Negro mate pulsadores para orificios de Ø60 mm			

RECAMBIOS TIRADORES

EQUIPAMIENTO WC

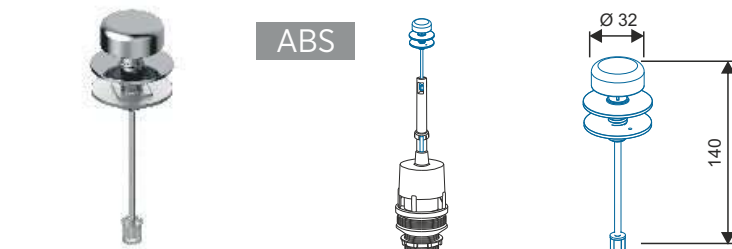

ABS

Cod.		€	Embalaje	
30305	Tirador UNIVERSAL ABS cromado con varilla metálica recta	4,50	Bolsa	25/bolsa

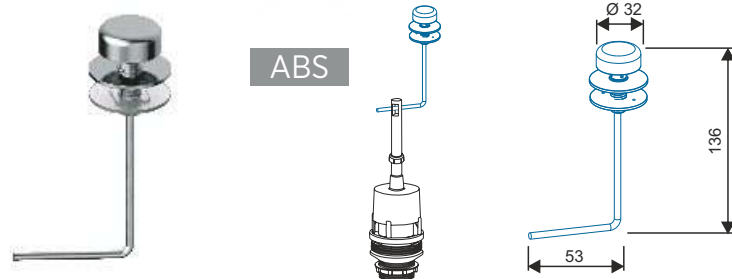

ABS

Cod.		€	Embalaje	
30306	Tirador ABS cromado con varilla metálica en ángulo	4,50	Bolsa	25/bolsa

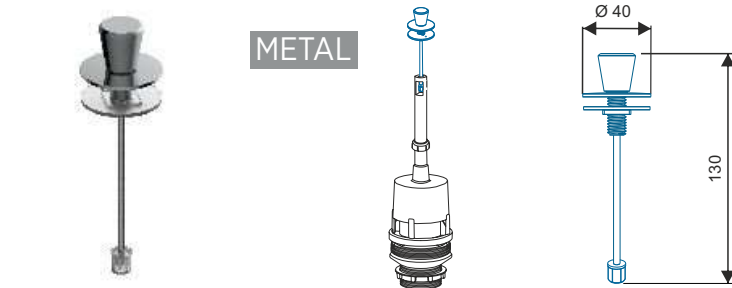

METAL

Cod.		€	Embalaje	
30308	Tirador pomo metálico cromado con varilla metálica recta	6,50	Bolsa	25/bolsa

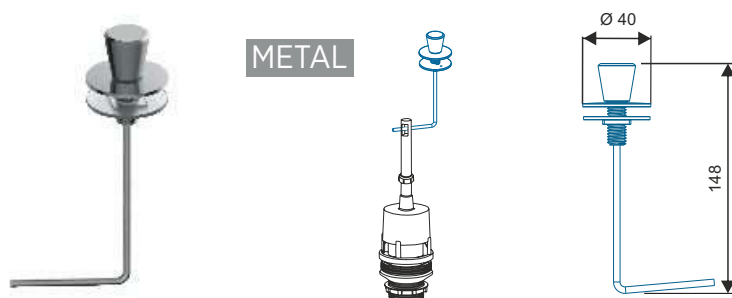

METAL

Cod.		€	Embalaje	
30309	Tirador pomo metálico cromado con varilla metálica en ángulo	6,95	Bolsa	25/bolsa

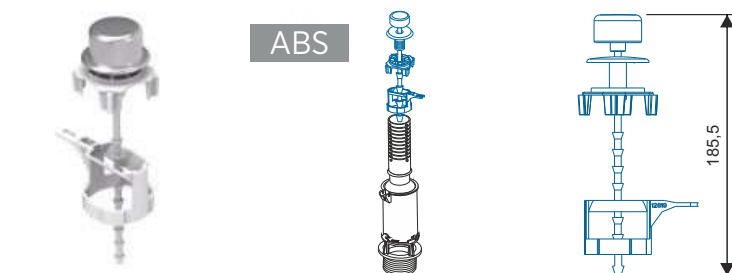

ABS

Cod.		€	Embalaje	
30304	Tirador ABS cromado para mod. Alcora	2,75	Bolsa	10/bolsa

RECAMBIOS CISTERNA SEMI-ALTA, BAJA EQUIPAMIENTO WC

Modelo / Modelo
SUPER / SUPER-DUO

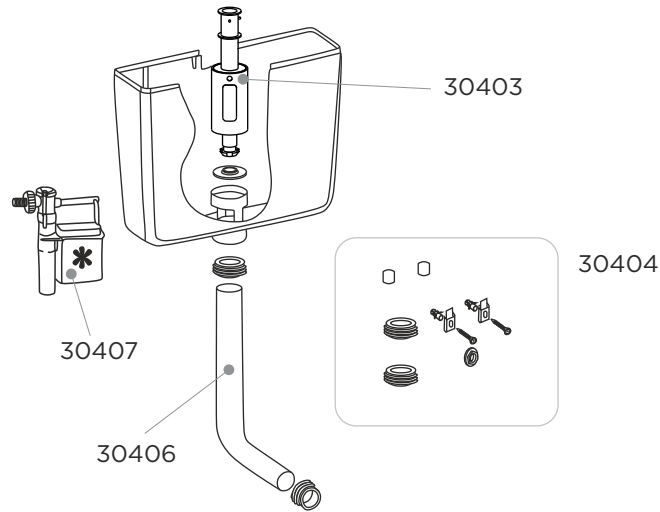

Modelo
LUX-MONOBLOCK

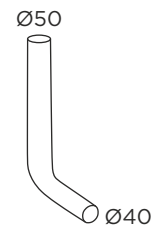
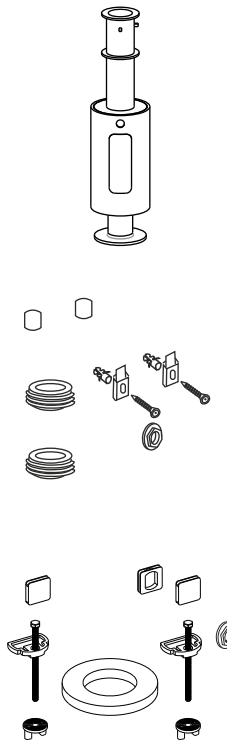
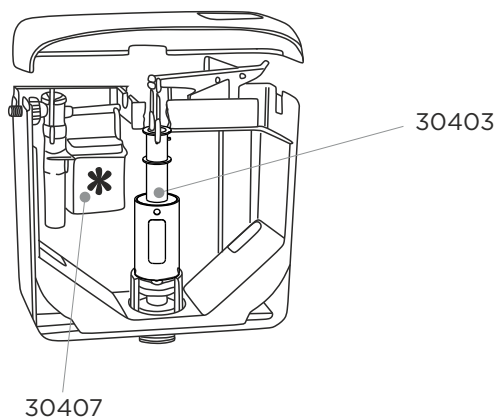

Cod.		€	
30403	Descargador para cisterna SUPER, SUPER-DUO y LUX-MONOBLOCK con goma de cierre	17,30	-

Cod.		€	
30404	Kit de complementos para cisternas semi-altas SUPER y SUPER-DUO	11,45	-

Cod.		€	
30405	Kit de complementos para cisterna baja LUX-MONOBLOCK	14,75	-

Cod.		€	
30406	Codo para cisternas semi-altas SUPER y SUPER-DUO	9,60	-

Cod.		€	
30407	Grifo alimentación lateral para cisternas SUPER, SUPER-DUO y LUX-MONOBLOCK	21,95	-

Cod.		€	
30408	Tapa cisterna modelo Super 40100	21,95	-
30409	Tapa cisterna modelo Super-Duo 40101	23,95	-
30410	Tapa cisterna modelo Lux-Monoblock 40102	26,80	-

Nos adaptamos a tus necesidades

En Idrosponia contamos con distintos formatos de presentación para nuestros productos, de forma que puedas elegir según tus necesidades

Consultar condiciones

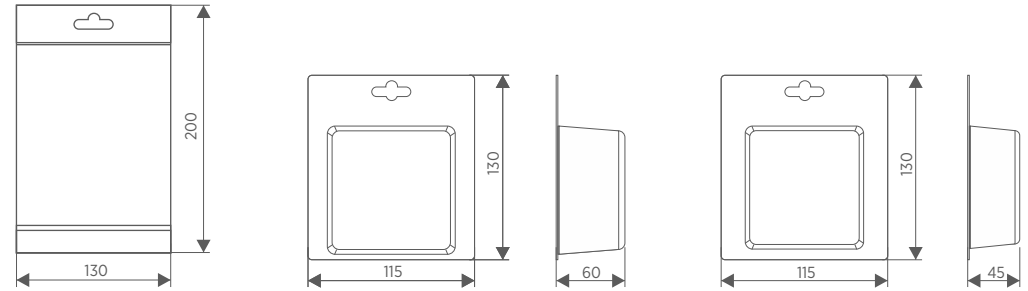

FORMATO BOLSA



FORMATO BLISTER

CLICK-CLACK Y SIFONES
LATÓN/ZINC
ACERO INOXIDABLE



VÁLVULAS CLICK-CLACK CROMADAS

SIFONES Y VÁLVULAS

TODOS LOS MODELOS SE PRESENTAN EN CAJA INDIVIDUAL

Cod.		€	
30611	Válvula latón cromado click-clack. Tapón exterior grande Ø63	14,30	50

COMPLETA

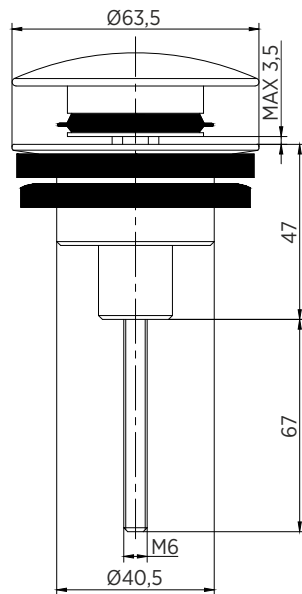
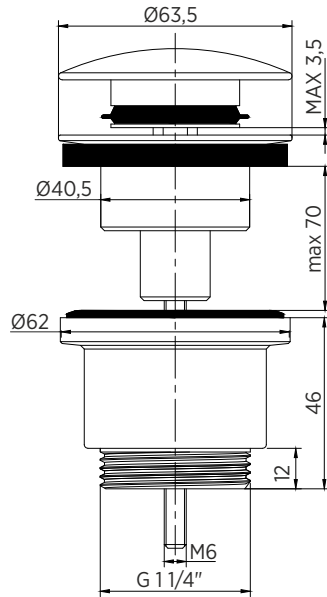

Cod.		€	
30624	Conjunto superior latón cromado click-clack. Tapón exterior grande Ø63	11,30	50

RECAMBIO

Transforma su válvula convencional en sistema click-clack



*(Recambios en pág. 128)

VÁLVULAS CLICK-CLACK CROMADAS

SIFONES Y VÁLVULAS

TODOS LOS MODELOS SE PRESENTAN EN CAJA INDIVIDUAL

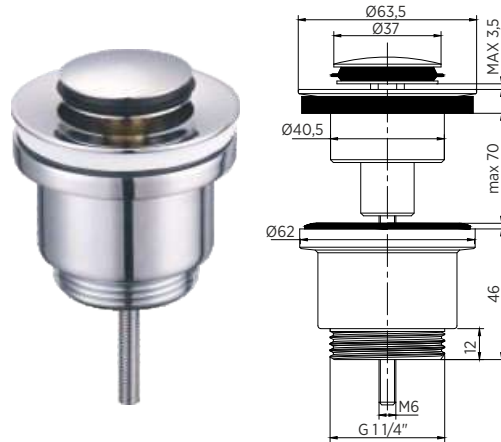

Cod.		€	
30607	Válvula latón cromado click-clack. Tapón interior pequeño Ø37	14,05	50

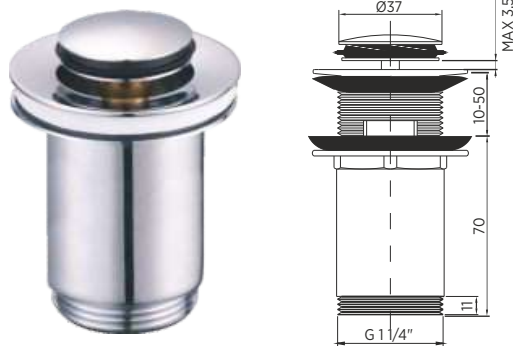

Cod.		€	
30650	Válvula cromado larga click-clack. Tapón interior pequeño Ø37	14,95	50

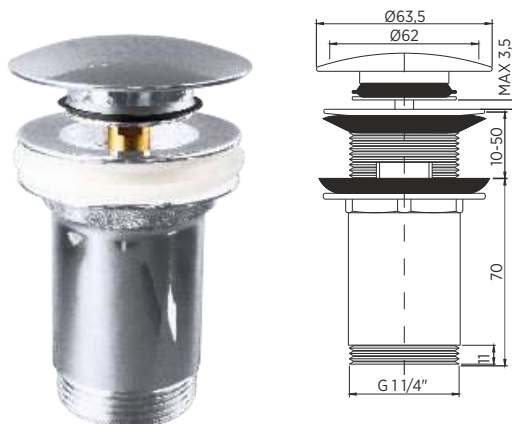

Cod.		€	
30608	Válvula cromado larga click-clack. Tapón exterior grande Ø63	15,10	50

TODOS LOS MODELOS SE PRESENTAN EN CAJA INDIVIDUAL

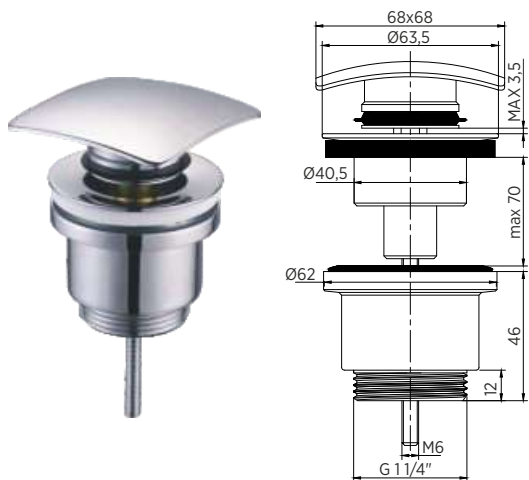

Cod.		€	
30612	Válvula latón cromado click-clack. Tapón exterior cuadrado	17,05	50

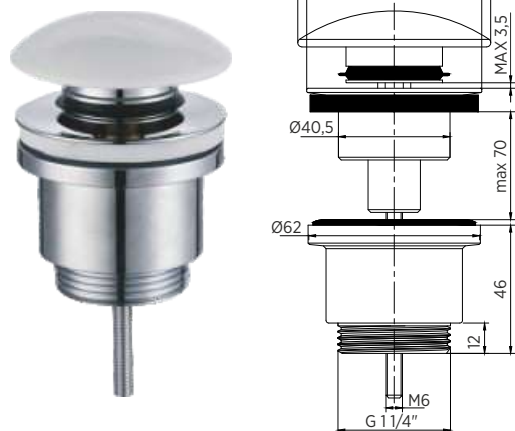

Cod.		€	
30625	Válvula latón cromado click-clack. Tapón exterior PORCELANA CERÁMICA COLOR BLANCO	18,20	50

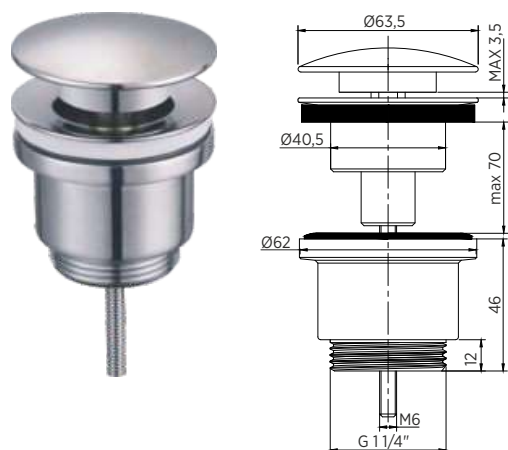

Cod.		€	
30649	Válvula latón cromado SIEMPRE ABIERTA. Tapón exterior grande Ø63	13,90	50

SIEMPRE ABIERTA

VÁLVULAS CLICK-CLACK CROMADAS

SIFONES Y VÁLVULAS



INOX

PRODUCTO NUEVO

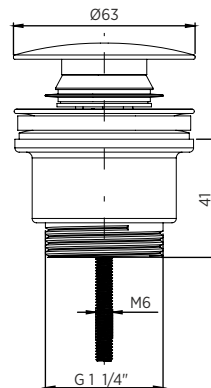
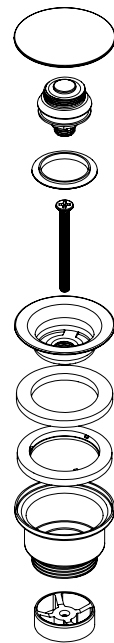

ASPA DE MATERIAL POM/PLÁSTICO

EJE DE MATERIAL POM/PLÁSTICO ANTICAL

Cod.		€	
30655	Válvula click-clack acero inoxidable. Sistema anticalcáreo. Acabado cromado	12,60	25
30655.NE	Válvula click-clack acero inoxidable. Sistema anticalcáreo. Acabado negro mate	13,40	25
30655.BLM	Válvula click-clack acero inoxidable. Sistema anticalcáreo. Acabado blanco mate	13,40	25

VÁLVULAS CLICK-CLACK CROMADAS

SIFONES Y VÁLVULAS

TODOS LOS MODELOS SE PRESENTAN EN CAJA INDIVIDUAL



REGISTRABLE



REGISTRABLE



REGISTRABLE

Cod.		€	
30600	Sifón botella LATÓN cromado diseño minimalista cilíndrico Embalaje LUXE	37,05	-

30600.Z	Sifón botella ZINC cromado diseño minimalista cilíndrico	32,35	-
----------------	--	-------	---

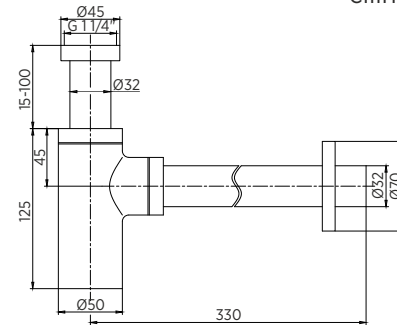

Cod.		€	
30622	Sifón botella LATÓN cromado diseño minimalista cuadrado Embalaje LUXE	48,85	-

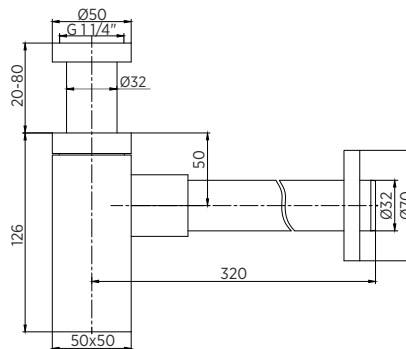

Cod.		€	
30636	Sifón botella LATÓN cromado diseño minimalista cilíndrico ahorro de espacio Embalaje LUXE	72,35	-

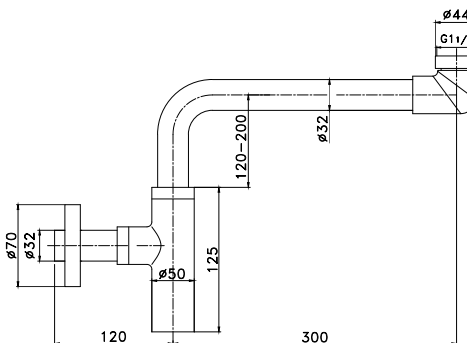

*(Recambios en pág. 128)

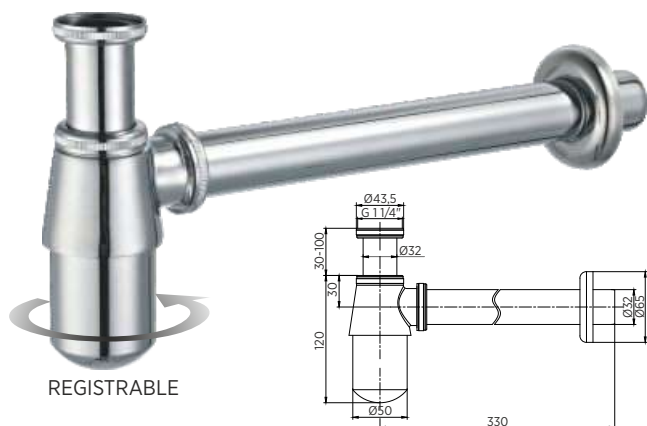

TODOS LOS MODELOS SE PRESENTAN EN CAJA INDIVIDUAL

Cod.		€	
30602	Sifón botella LATÓN cromado	22,65	-
30602.Z	Sifón botella ZINC cromado	19,45	-

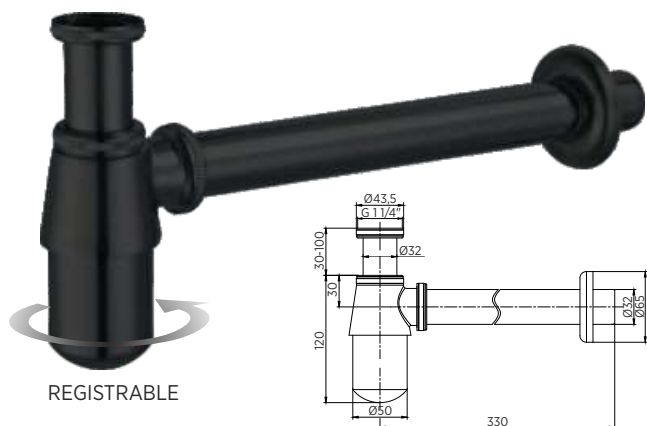

Cod.		€	
30602.NE	Sifón botella LATÓN negro mate	28,70	-
30602.Z.NE	Sifón botella ZINC negro mate	23,75	-

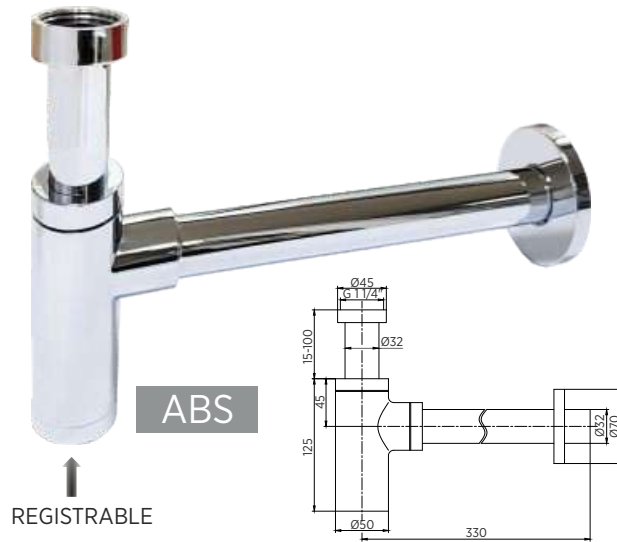

Cod.		€	
30647	Sifón botella ABS cromado diseño minimalista cilíndrico	18,40	25
	ECO		



Cod.		€	
30648	Válvula ABS cromado click-clack. Tapón exterior grande Ø63 INOX	9,80	50
	ECO		

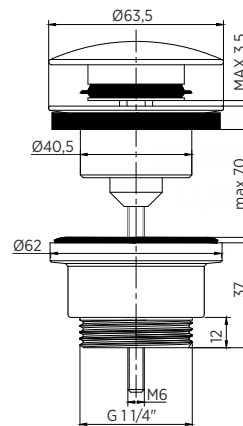



CLICK-CLACK Y
SIFONES ACABADOS ESPECIALES

TODOS LOS MODELOS SE PRESENTAN EN CAJA INDIVIDUAL

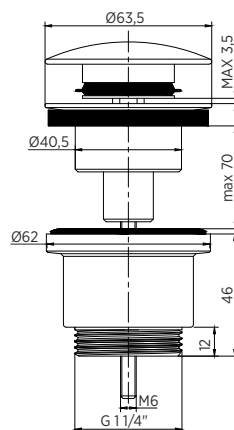
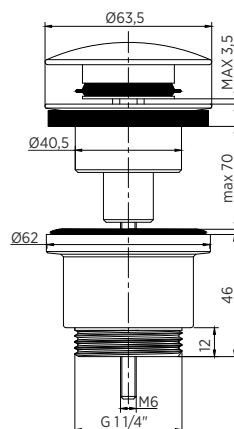
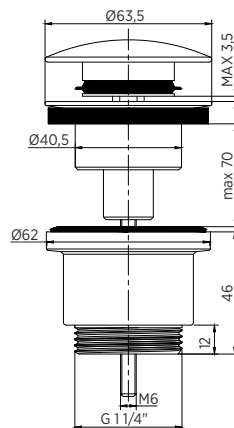

Cod.		€	
30611.NE	Válvula click-clack latón. Acabado NEGRO MATE. Tapón exterior grande Ø63	25,10	50

Cod.		€	
30611.BLM	Válvula click-clack latón. Acabado BLANCO MATE. Tapón exterior grande Ø63	24,20	50

Cod.		€	
30611.CO	Válvula click-clack latón. Acabado COBRE CEPILLADO. Tapón exterior grande Ø63	24,20	50

VÁLVULAS CLICK-CLACK

ACABADOS ESPECIALES

TODOS LOS MODELOS SE PRESENTAN EN CAJA INDIVIDUAL

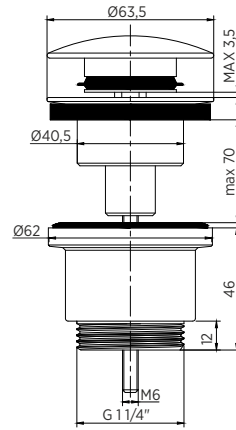

Cod.

€



30611.NI

Válvula click-clack latón.
Acabado NÍQUEL INOX CEPILLADO.
Tapón exterior grande Ø63

24,20

50

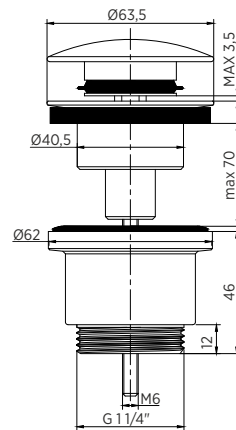

Cod.

€



30611.ORO

Válvula click-clack latón
Acabado ORO CEPILLADO.
Tapón exterior grande Ø63

24,20

50

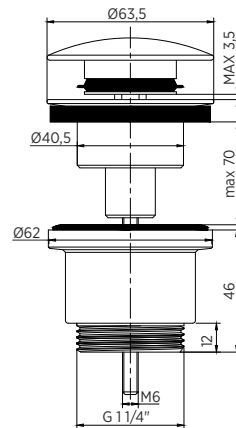

Cod.

€



30611.BRV

Válvula click-clack latón.
Acabado BRONCE VIEJO CEPILLADO.
Tapón exterior grande Ø63

24,20

50



TODOS LOS MODELOS SE PRESENTAN EN CAJA INDIVIDUAL



Cod.	€	
------	---	--

30600.NE

Sifón botella latón.
Acabado NEGRO MATE.
Diseño minimalista cilíndrico

67,10



-

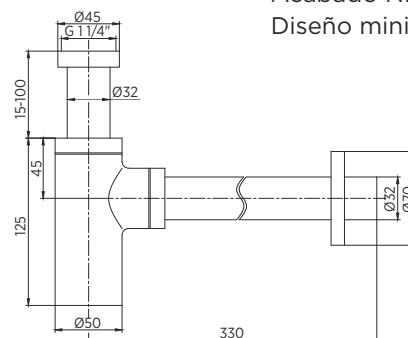

Cod.	€	
------	---	--

30600.BLM

Sifón botella latón.
Acabado BLANCO MATE.
Diseño minimalista cilíndrico

67,10



-

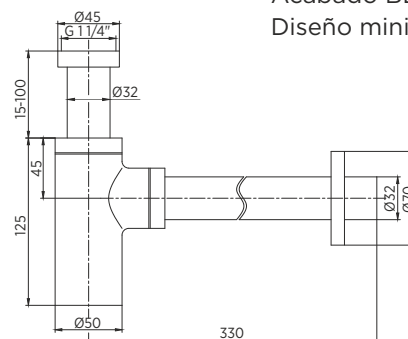

Cod.	€	
------	---	--

30600.CO

Sifón botella latón.
Acabado COBRE CEPILLADO.
Diseño minimalista cilíndrico

60,40



-

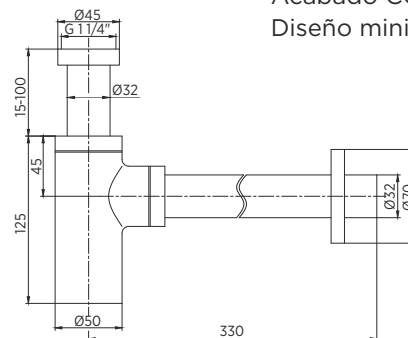

*(Recambios en pág. 128)

SIFONES
ACABADOS ESPECIALES

TODOS LOS MODELOS SE PRESENTAN EN CAJA INDIVIDUAL



Cod.

€



30600.NI

Sifón botella latón.
Acabado NÍQUEL INOX CEPILLADO.
Diseño minimalista cilíndrico

60,40

-

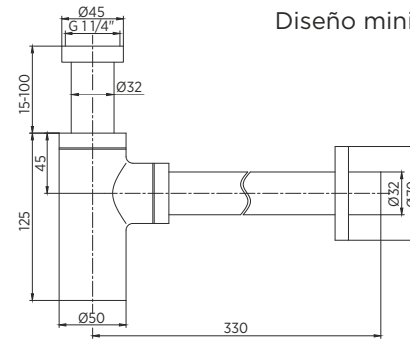

Cod.

€



30600.ORO

Sifón botella latón.
Acabado ORO CEPILLADO.
Diseño minimalista cilíndrico

60,40

-

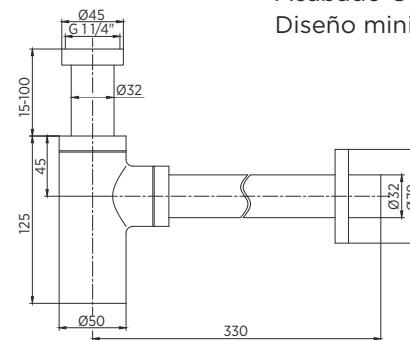

Cod.

€



30600.BRV

Sifón botella latón.
Acabado BRONCE VIEJO CEPILLADO.
Diseño minimalista cilíndrico

60,40

-

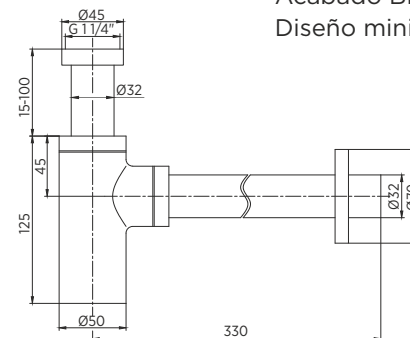

*(Recambios en pág. 128)



TODOS LOS MODELOS SE PRESENTAN EN CAJA INDIVIDUAL

Cod.		€	
30652.BLM	Sifón botella ABS. Acabado BLANCO MATE. Diseño minimalista cuadrado	21,50	-
30652.NE	Sifón botella ABS. Acabado NEGRO MATE. Diseño minimalista cuadrado	22,50	-

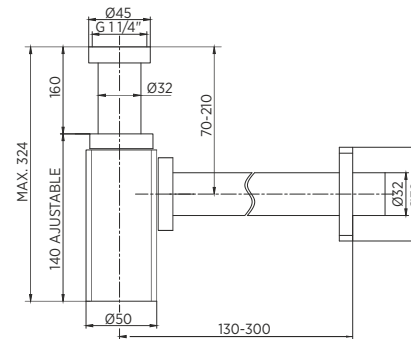

ADAPTOR GASKET



Cod.		€	
30647.BLM	Sifón botella ABS. Acabado BLANCO MATE. Diseño minimalista cilíndrico	20,50	-
30647.NE	Sifón botella ABS. Acabado NEGRO MATE. Diseño minimalista cilíndrico	21,50	-

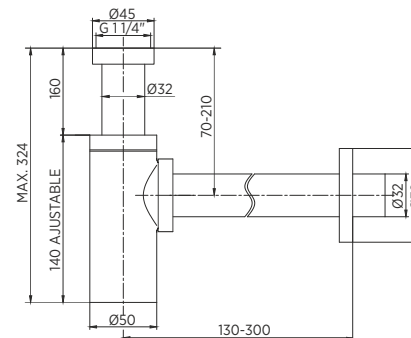

ADAPTOR GASKET



RECAMBIOS CLICK-CLACK Y SIFONES

RECAMBIOS CLICK-CLACK Y SIFONES



Cod.		€	
30629	Tubo para sifón botella latón longitud 300 mm acabado CROMADO	5,50	50
30629.NE	Tubo para sifón botella latón longitud 300 mm acabado NEGRO MATE	8,95	50
30629.BLM	Tubo para sifón botella latón longitud 300 mm acabado BLANCO MATE	6,85	50
30629.CO	Tubo para sifón botella latón longitud 300 mm acabado COBRE CEPILLADO	6,85	50
30629.NI	Tubo para sifón botella latón longitud 300 mm acabado NÍQUEL INOX CEPILLADO	6,85	50
30629.ORO	Tubo para sifón botella latón longitud 300 mm acabado ORO CEPILLADO	6,85	50
30629.BRV	Tubo para sifón botella latón longitud 300 mm acabado BRONCE VIEJO CEPILLADO	6,85	50

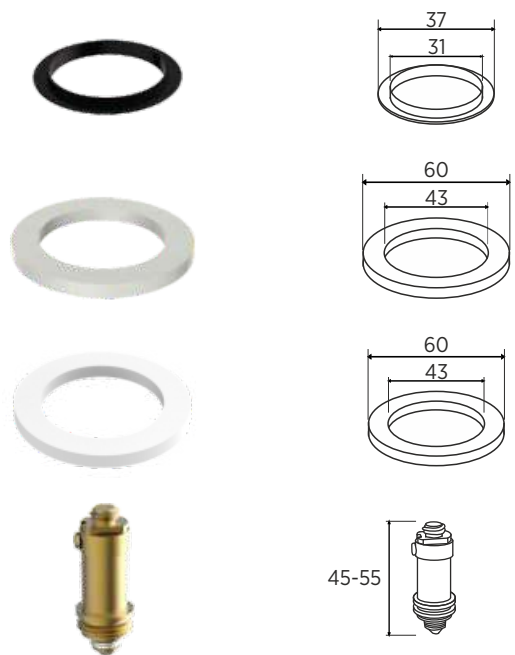

Cod.		€	
30416	Goma cierre valvulas click-clack	0,70	50
30417	Junta PVC valvulas click-clack	0,85	50
30418	Junta goma espuma valvulas click-clack	0,65	50
30419	Mecanismo interior valvulas click clack de tapón exterior grande	3,20	50



LAVABO BIDET

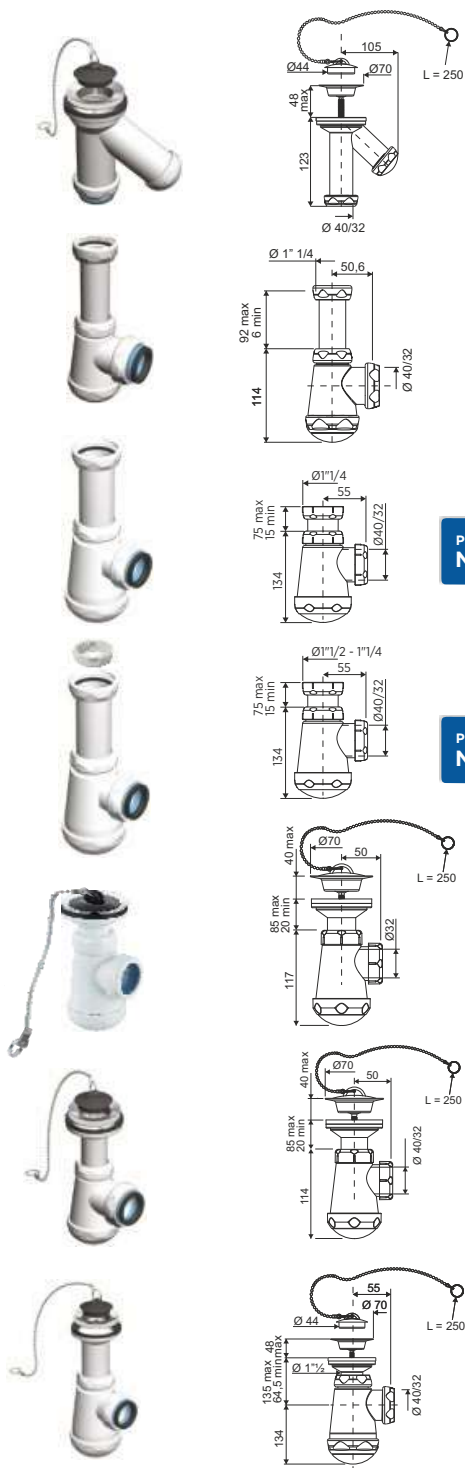

PRODUCTO
NUEVO

PRODUCTO
NUEVO

EASYFIT

Ref.	Cod.		€	
I-01	660401	Sifón "Y" compacto, válvula lavabo-bidet, con salida Ø40 mm, y junta cónica reductora Ø32 mm	6,65	50

Ref.	Cod.		€	
I-02	660402	Sifón botella corto extensible, salida horizontal Ø40 mm, con reductora Ø32 mm, racor 1" 1/4 para lavabo-bidet	4,45	80

Ref.	Cod.		€	
	661205	Sifón botella extensible, salida horizontal Ø40 mm, con reductora Ø32 mm, y racor 1"1/4	4,65	45

Ref.	Cod.		€	
	660533	Sifón botella racor extensible 1" 1/2 con reductora 1/4 salida horizontal 40/32	5,25	60

Ref.	Cod.		€	
I-03	660403	Sifón botella corto extensible, salida horizontal Ø32 mm, válvula lavabo-bidet 1" 1/4 x 70	6,65	65

EASYFIT

Ref.	Cod.		€	
I-03	660403.E	Sifón botella corto extensible, salida horizontal Ø40 mm, con reductora Ø32 mm, válvula lavabo-bidet 1" 1/4 x 70	7,25	60

EASYFIT

Ref.	Cod.		€	
I-04	660404	Sifón botella extensible, salida horizontal Ø40 mm, con reductora Ø32 mm, válvula lavabo-bidet 1" 1/2 x70	7,45	45

LAVABO-BIDET

SIFONES Y VÁLVULAS

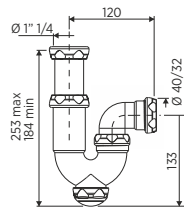
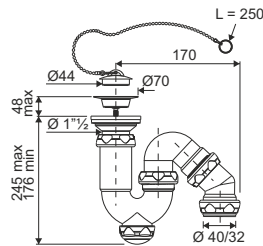
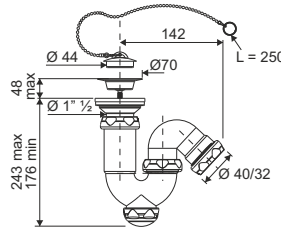
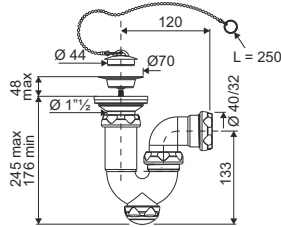

PRODUCTO NUEVO

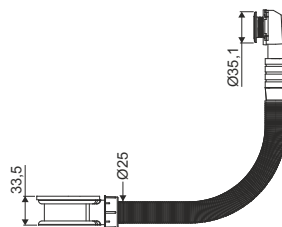

EASYFIT

Ref.	Cod.		€	
I-05	660405	Sifón curvo extensible, salida horizontal Ø40 mm, con reductora Ø32 mm, válvula lavabo-bidet 1" 1/2 x 70	7,45	40

EASYFIT

Ref.	Cod.		€	
I-06	660406	Sifón curvo extensible, salida inclinada Ø40 mm, con reductora Ø32 mm, válvula lavabo-bidet 1" 1/2 x 70	7,45	35

EASYFIT

Ref.	Cod.		€	
I-07	660407	Sifón curvo extensible, salida orientable Ø40 mm, con reductora Ø32 mm, válvula lavabo-bidet 1" 1/2 x 70	7,95	30

Ref.	Cod.		€	
	660527	Sifón curvo extensible, salida horizontal Ø40 mm, con reductora Ø32 mm, racor 1"1/4	4,95	40

Ref.	Cod.		€	
I-270	660518	Adaptador extensible para lavabos con rebosadero redondo ABS CROMADO. SIN VÁLVULA	3,85	50



EASYFIT

Ref.	Cod.		Emb.	€	
I-60	660435.E	Válvula lavabo-bidet 1" 1/4 x 70	BOLSA	4,85	65

Ref.	Cod.		Emb.	€	
I-60	660435	Válvula lavabo-bidet 1" 1/4 x 70	BOLSA	3,70	65
I-272	660520		BLISTER	4,60	85

EASYFIT

Ref.	Cod.		Emb.	€	
I-61	660436.E	Válvula lavabo-bidet 1" 1/2 x 70	BOLSA	5,05	65

Ref.	Cod.		Emb.	€	
I-273	660521	Válvula lavabo-bidet 1" 1/2 x 70	BLISTER	4,65	85

Ref.	Cod.		Emb.	€	
I-275	660523	Válvula lavabo-bidet 1" 1/4 x 70 con tapón metálico	BOLSA	4,20	75
I-276	660524		BLISTER	4,90	85

Ref.	Cod.		Emb.	€	
I-277	660525	Válvula lavabo-bidet 1" 1/2 x 70 con tapón metálico	BOLSA	4,35	75
I-278	660526		BLISTER	4,95	85

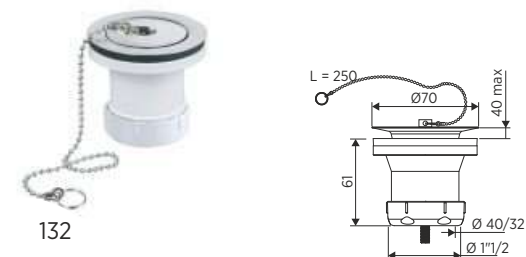
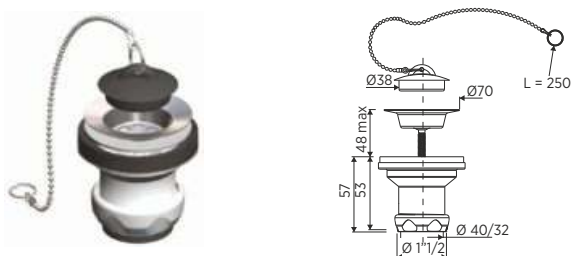
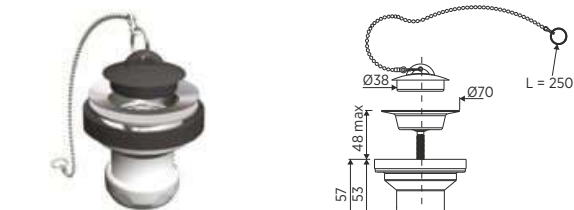



FREGADERO



Cod.		€	
661164	Válvula cesta ACERO INOX para fregadero 1"1/2 x115 con tornillo para instalación tanto de fregaderos inoxidables como sintéticos	13,45	50
661164.NE	Válvula cesta ACERO INOX acabado NEGRO para fregadero 1"1/2 x115 con tornillo para instalación tanto de fregaderos inoxidables como sintéticos	17,80	50
661164.GR	Válvula cesta ACERO INOX acabado GRAFITO para fregadero 1"1/2 x115 con tornillo para instalación tanto de fregaderos inoxidables como sintéticos	17,80	50
661164.ORO	Válvula cesta ACERO INOX acabado ORO para fregadero 1"1/2 x115 con tornillo para instalación tanto de fregaderos inoxidables como sintéticos	17,80	50



Cod.		€	
661165	Válvula cesta ACERO INOX para fregadero con dos rebosaderos flexibles rectangular/redondo 1"1/2 x 115 con tornillo para instalación tanto de fregaderos inoxidables como sintéticos	17,80	30
661165.NE	Válvula cesta ACERO INOX acabado NEGRO para fregadero con dos rebosaderos flexibles rectangular/redondo 1"1/2 x 115 con tornillo para instalación tanto de fregaderos inoxidables como sintéticos	22,90	30
661165.GR	Válvula cesta ACERO INOX acabado GRAFITO para fregadero con dos rebosaderos flexibles rectangular/redondo 1"1/2 x 115 con tornillo para instalación tanto de fregaderos inoxidables como sintéticos	22,90	30
661165.ORO	Válvula cesta ACERO INOX acabado ORO para fregadero con dos rebosaderos flexibles rectangular/redondo 1"1/2 x 115 con tornillo para instalación tanto de fregaderos inoxidables como sintéticos	22,90	30

FREGADERO

SIFONES Y VÁLVULAS

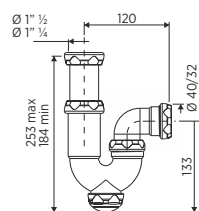
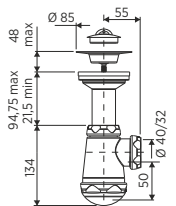
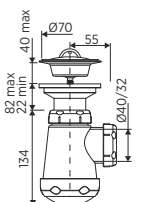
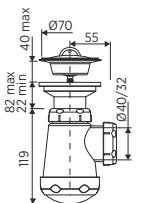
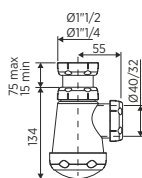

PRODUCTO NUEVO

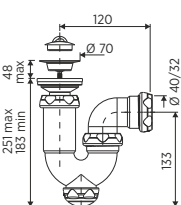

Ref.	Cod.		€	
I-20	660410.E	Sifón botella extensible, salida horizontal Ø40 mm, con reductora Ø32 mm, y racor 1"1/2 para fregadero	4,65	60

Ref.	Cod.		€	
I-21	660411	Sifón botella extensible, salida horizontal Ø40 mm, con reductora Ø32 mm, válvula fregadero 1"1/2 x 70	5,40	45

Ref.	Cod.		€	
I-21	660411.E	Sifón botella extensible, salida horizontal Ø40 mm, con reductora Ø32 mm, válvula fregadero 1"1/2 x 70	6,45	45

EASYFIT

Ref.	Cod.		€	
I-22	660412	Sifón botella extensible, salida horizontal Ø40 mm, con reductora Ø32 mm, válvula fregadero 1"1/2 x 85	6,50	45

Ref.	Cod.		€	
I-23	660413	Sifón curvo extensible, salida horizontal Ø40 mm, con reductora Ø32 mm, racor 1"1/2 para fregadero	5,10	40

	660527	Sifón curvo extensible, salida horizontal Ø40 mm, con reductora Ø32 mm, racor 1"1/4	4,95	40
--	---------------	---	------	----

EASYFIT

Ref.	Cod.		€	
I-24	660414	Sifón curvo extensible, salida horizontal Ø40 mm con reductora Ø32 mm, válvula fregadero 1"1/2 x 70	6,65	35



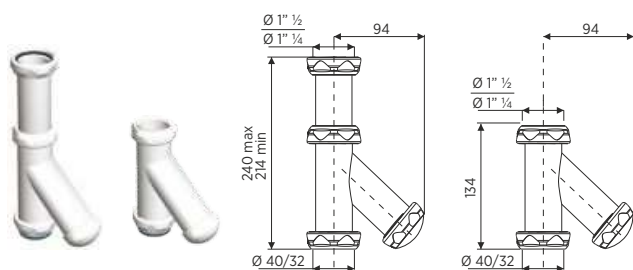

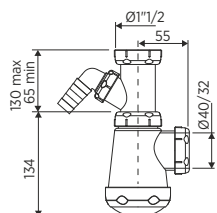

Ref.	Cod.		€	
I-29	660419	Sifón "Y" extensible, salida Ø40 mm, con reductora Ø32 mm, y racor 1" 1/2 para fregadero	4,75	50
I-94	660462	Sifón "Y" extensible, salida Ø40 mm, con reductora Ø32 mm, y racor 1" 1/4 para fregadero	4,80	50
I-282	660532	Sifón "Y" SIN EXTENSIBLE, salida Ø40 mm, con reductora Ø32	4,15	50

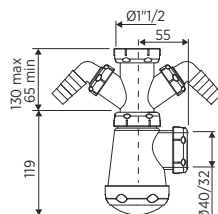

Ref.	Cod.		€	
I-30	660420.E	Sifón botella extensible, salida horizontal Ø40 mm, con reductora Ø32 mm, racor 1"1/2 con una toma auxiliar para fregadero	5,40	45



Ref.	Cod.		€	
I-31	660421	Sifón botella extensible, salida horizontal Ø40 mm, con reductora Ø32 mm, racor 1" 1/2 con dos tomas auxiliares para fregadero	4,95	40

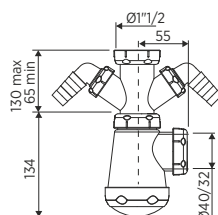

Ref.	Cod.		€	
I-31	660421.E	Sifón botella extensible, salida horizontal Ø40 mm, con reductora Ø32 mm, racor 1" 1/2 con dos tomas auxiliares para fregadero	5,80	40

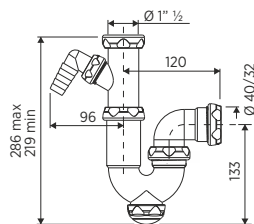

Ref.	Cod.		€	
I-32	660422	Sifón curvo extensible, salida horizontal Ø40 mm, con reductora Ø32 mm, racor 1" 1/2 con una toma auxiliar para fregadero	5,90	35

FREGADERO

SIFONES Y VÁLVULAS

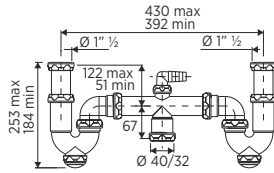

Ref.	Cod.		€	
------	------	--	---	--

I-40	660425	Sifón curvo doble, extensible, salida orientable, con racores 1"1/2 y toma auxiliar para fregadero	10,65	15
------	---------------	--	-------	----

EASYFIT

Ref.	Cod.		€	
------	------	--	---	--

I-41	660426	Sifón curvo doble, extensible, salida orientable con válvulas 1" 1/2 x 70 y toma auxiliar para fregadero	13,35	14
------	---------------	--	-------	----

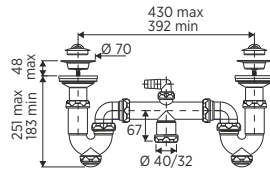

Ref.	Cod.		€	
------	------	--	---	--

I-42	660427	Sifón curvo, extensible, salida horizontal Ø40 mm, con reductora Ø32 mm, con doble racor extensible 1"1/2 y una toma auxiliar para fregadero	11,40	14
------	---------------	--	-------	----

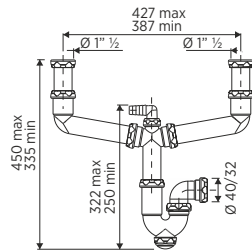

EASYFIT

Ref.	Cod.		€	
------	------	--	---	--

I-43	660428	Sifón curvo, extensible, salida horizontal Ø40 mm, con reductora Ø32 mm, con doble válvula fregadero 1" 1/2 x 70 y una toma auxiliar	14,35	12
------	---------------	--	-------	----

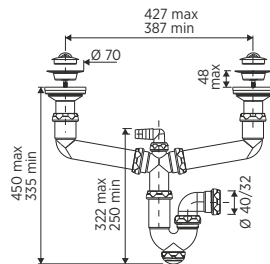

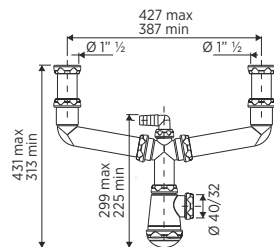

Ref.	Cod.		€	
I-44	660429	Sifón botella extensible, salida horizontal Ø40 mm, con reductora Ø32 mm, con doble racor extensible 1" 1/2 y una toma auxiliar para fregadero	11,20	15

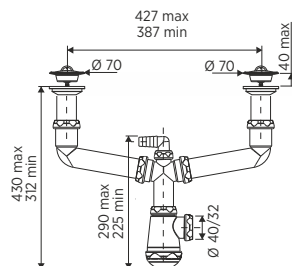

EASYFIT

Ref.	Cod.		€	
I-45	660430.E	Sifón botella, extensible, salida horizontal Ø40 mm, con reductora Ø32 mm, con doble válvula fregadero 1"1/2x70 y una toma auxiliar	13,80	12

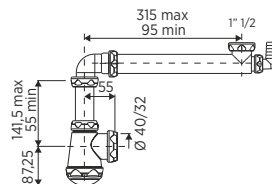

Ref.	Cod.		€	
I-50	661181	Sifón botella extensible salida horizontal Ø40 mm, con reductora Ø32 mm, ahorro espacio y toma auxiliar (un seno) para fregadero	8,45	22

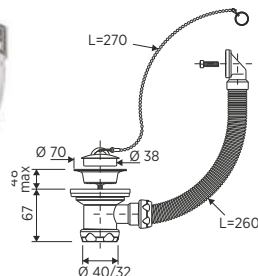

EASYFIT

Ref.	Cod.		€	
I-65	660440	Válvula con rebosadero flexible rectangular sin chapa, válvula 1"1/2 x 70 para fregadero	8,90	40

FREGADERO

SIFONES Y VÁLVULAS

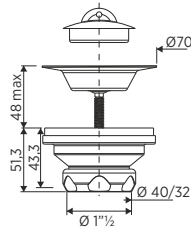

EASYFIT

Ref.	Cod.		€	
I-62	660437.E	Válvula fregadero 1"1/2x 70	4,20	65

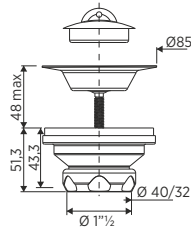

EASYFIT

Ref.	Cod.		€	
I-63	660438	Válvula fregadero 1"1/2 x 85	4,55	50

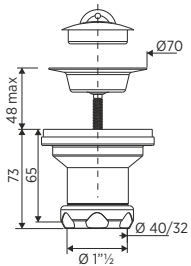



EASYFIT

Ref.	Cod.		€	
I-64	660439	Válvula alta fregadero 1"1/2 x 70	4,50	50

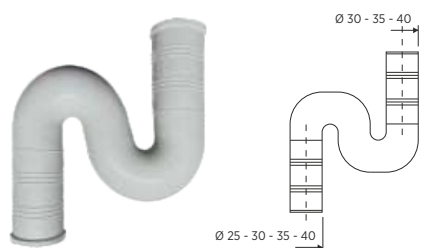

Ref.	Cod.		€	
I-303	660553	Sifón flexible desagüe pared 25x30 mm	7,25	-
I-304	660554	Sifón flexible desagüe pared 30x30 mm	7,25	-
I-305	660555	Sifón flexible desagüe pared 35x35 mm	7,25	-
I-306	660556	Sifón flexible desagüe pared 35x40 mm	7,25	-
I-307	660557	Sifón flexible desagüe pared 40x40 mm	7,40	-



Ref.	Cod.		€	
I-308	660558	Sifón flexible desagüe a suelo 25x30 mm	7,40	-
I-309	660559	Sifón flexible desagüe a suelo 30x30 mm	7,40	-
I-310	660560	Sifón flexible desagüe a suelo 35x35 mm	7,40	-
I-311	660561	Sifón flexible desagüe a suelo 40x40 mm	7,60	-

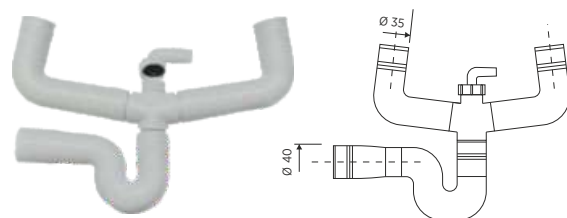

Ref.	Cod.		€	
I-312	660562	Sifón doble completo desagüe fregadero Ø 35 x40 mm con toma para lavavajillas. Codos cortos	18,55	-
I-313	660563	Sifón doble completo desagüe fregadero Ø 35 x40 mm con toma para lavavajillas. Codos largos	20,50	-

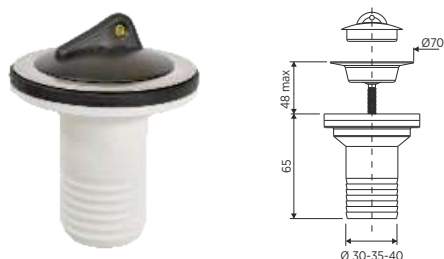

Ref.	Cod.		€	
I-300	660550	Válvula de fregadero con junta incorporada en cuerpo Ø 30 mm	8,80	-
I-301	660551	Válvula de fregadero con junta incorporada en cuerpo Ø 35 mm	8,80	-
I-302	660552	Válvula de fregadero con junta incorporada en cuerpo Ø 40 mm	8,80	-



DUCHA

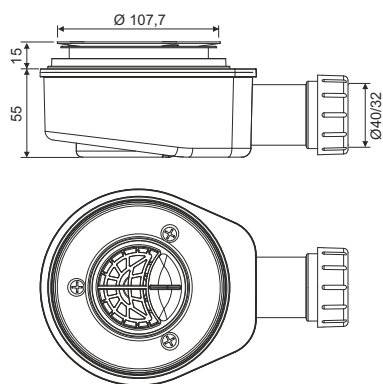

Ref.	Cod.		Emb.	€	
I-265	660513	Válvula sifónica extraplana plato de ducha SIN EMBELLECEDOR	CAJA	15,65	32

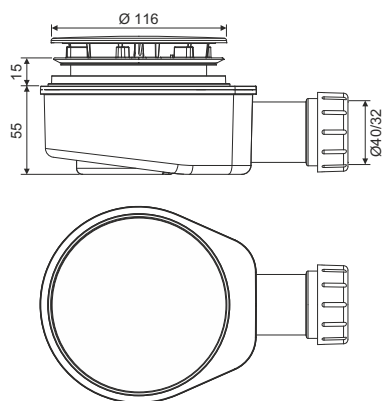

Ref.	Cod.		Emb.	€	
I-267	660515	Válvula sifónica extraplana plato de ducha CON EMBELLECEDOR ABS CROMADO	CAJA	18,50	24



Ref.	Cod.		€	
	660534	Válvula sifónica extraplana plato de ducha SIN EMBELLECEDOR. Brida de fijación INOX	17,15	32

SISTEMA anclaje a rejilla

DUCHA

SIFONES Y VÁLVULAS

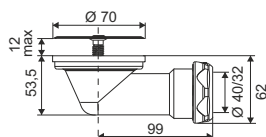

Ref.	Cod.		€	
I-100	660465	Válvula para plato ducha con orificio Ø50 mm, salida horizontal Ø40 mm con reductora Ø32 mm, rejilla inox. Ø70 mm (bote sifónico)	4,40	50

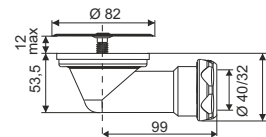

Ref.	Cod.		€	
I-101	660466	Válvula para plato ducha con orificio Ø60 mm, salida horizontal Ø40 mm con reductora Ø32 mm, con rejilla inox. Ø82 mm (bote sifónico)	4,45	75

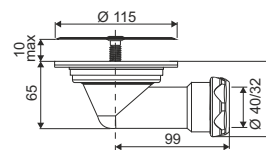

Ref.	Cod.		€	
I-108	661152	Válvula para plato ducha con orificio Ø90 mm, salida horizontal Ø40 mm con reductora Ø32 mm, con rejilla inox. Ø115 mm (bote sifónico)	6,00	55

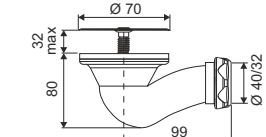

Ref.	Cod.		€	
I-103	660468	Válvula sifónica para plato ducha con orificio Ø50 mm, salida horizontal Ø40 mm con reductora Ø32 mm, rejilla inox. Ø70 mm	4,95	75

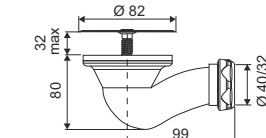

Ref.	Cod.		€	
I-104	660469	Válvula sifónica para plato ducha con orificio Ø60 mm, salida horizontal Ø40 mm con reductora Ø32 mm, rejilla inox. Ø82 mm	5,40	75

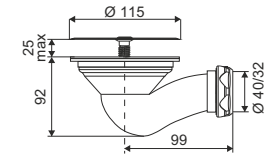



Ref.	Cod.		€	
I-107	661151	Válvula sifónica para plato ducha con orificio Ø90 mm, salida horizontal Ø40 mm con reductora Ø32 mm, con rejilla inox. Ø115 mm	6,55	50

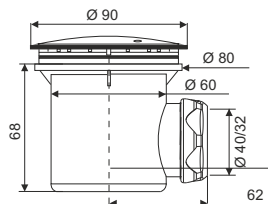



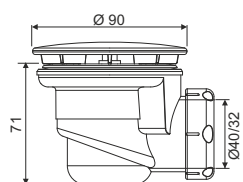

Ref.	Cod.		€	
I-105	660470	Válvula sifónica para plato ducha con orificio Ø60 mm, salida horizontal Ø40 mm con reductora Ø32 mm, CON EMBELLECEDOR ABS CROMADO REGISTRABLE	6,75	60

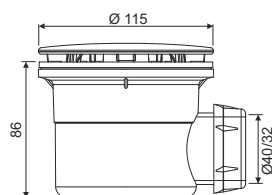

Ref.	Cod.		€	
I-112	661158	Válvula sifónica para plato ducha con orificio Ø60 mm, salida horizontal Ø40 mm con reductora Ø32 mm, CON EMBELLECEDOR ABS CROMADO REGISTRABLE	6,85	75



Ref.	Cod.		€	
I-113	661159	Válvula sifónica para plato ducha con orificio Ø90 mm, salida horizontal Ø40 mm con reductora Ø32 mm, CON EMBELLECEDOR ABS CROMADO REGISTRABLE	11,45	36

DUCHA

SIFONES Y VÁLVULAS

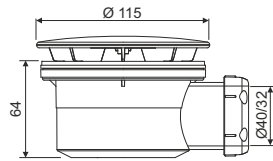

Ref.	Cod.		€	
I-109	661155	Válvula sifónica para plato ducha con orificio Ø90 mm, salida horizontal Ø40 mm, con reductora Ø32 mm, CON EMBELLECEDOR ABS CROMADO REGISTRABLE	11,45	45

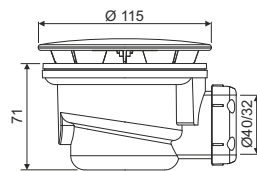

Ref.	Cod.		€	
I-111	661157	Válvula sifónica para plato ducha con orificio Ø90 mm, salida horizontal Ø40 mm, con reductora Ø32 mm, CON EMBELLECEDOR ABS CROMADO REGISTRABLE	11,45	45

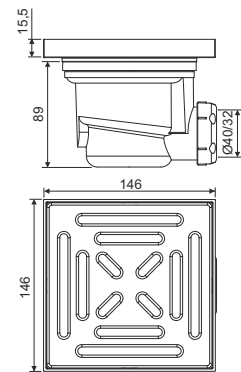

Ref.	Cod.		€	
I-110	661156	Sumidero para plato ducha de obra, con válvula sifónica salida horizontal Ø40 mm con reductora Ø32 mm CON TAPA ACERO INOX	14,00	30

INOX

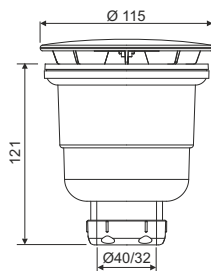

Ref.	Cod.		€	
I-82	661154	Válvula sifónica para plato ducha con orificio Ø90 mm, salida vertical Ø 40mm, con reductora Ø32 mm, CON EMBELLECEDOR ABS CROMADO REGISTRABLE	12,35	35



PRODUCTO NUEVO

*disponible 11/25

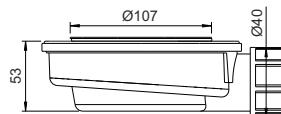

Ref.	Cod.		Emb.	€	
I-283	660535	Válvula sifónica extraplana plato de ducha sin embellecedor, salida horizontal 40 mm Brida de fijación INOX	CAJA	15,65	32



PRODUCTO NUEVO

*disponible 11/25

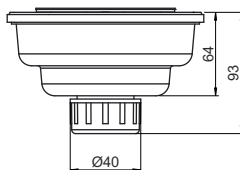

Ref.	Cod.		Emb.	€	
I-286	660538	Válvula sifónica extraplana plato de ducha sin embellecedor, salida vertical 40 mm Brida de fijación INOX	CAJA	15,65	25



PRODUCTO NUEVO

*disponible 11/25

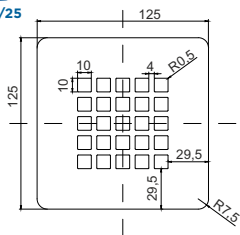

Ref.	Cod.		€	
I-287	660539	Rejilla ducha 12,5 * 12,5. Inox Cepillado	3,65	25
	660539.BLM	Rejilla ducha 12,5 * 12,5. Blanco Mate	6,00	25
	660539.NE	Rejilla ducha 12,5 * 12,5. Negro Mate	6,00	25

BAÑERA



PRODUCTO
NUEVO

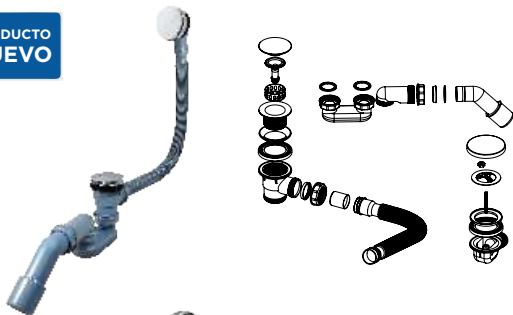

Ref.	Cod.	€	
------	------	---	--

660540	Válvula sifónica bañera click-clack salida horizontal con tuerca Ø40, con rebosadero flexible	28,90	18
---------------	---	-------	----

PRODUCTO
NUEVO

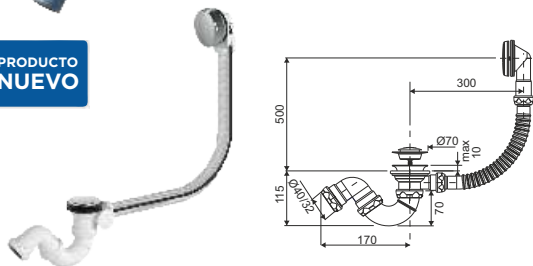

Ref.	Cod.	€	
------	------	---	--

660457	Válvula sifónica bañera automática, salida orientable (S) con tuerca Ø40mm, con rebosadero flexible	31,40	18
---------------	---	-------	----

PRODUCTO
NUEVO

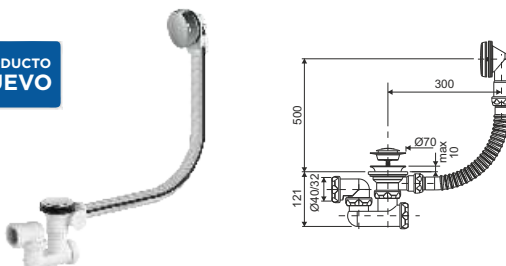

Ref.	Cod.	€	
------	------	---	--

660458	Válvula sifónica bañera automática, autolimpiable salida horizontal con tuerca Ø40mm, con rebosadero flexible	31,30	18
---------------	---	-------	----

PRODUCTO
NUEVO

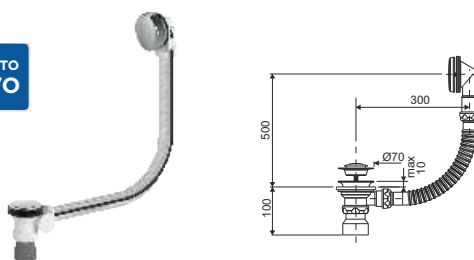

Ref.	Cod.	€	
------	------	---	--

660447	Válvula bañera automática, salida vertical PVC encolar Ø40mm	30,25	18
---------------	--	-------	----

PRODUCTO
NUEVO

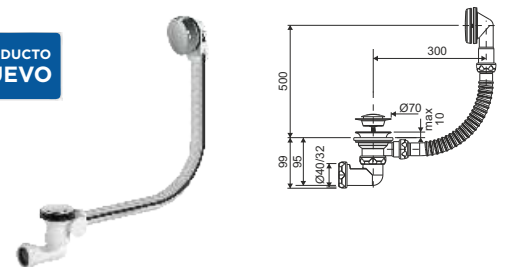



Ref.	Cod.	€	
------	------	---	--

660448	Válvula bañera automática, salida horizontal orientable con tuerca Ø40mm	30,50	18
---------------	--	-------	----

BAÑERA

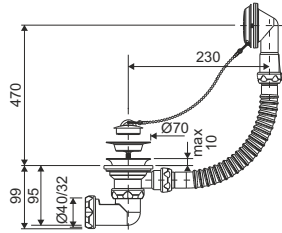
SIFONES Y VÁLVULAS



Ref.	Cod.		€	
I-80	660445	Válvula bañera salida horizontal, orientable con tuerca Ø40 mm, con rebosadero extensible	10,00	30

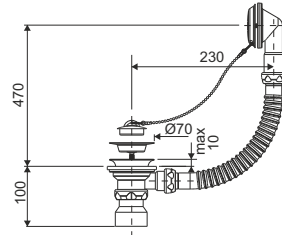

Ref.	Cod.		€	
I-81	660446	Válvula bañera salida vertical PVC encolar Ø40 mm, con rebosadero extensible	9,60	35

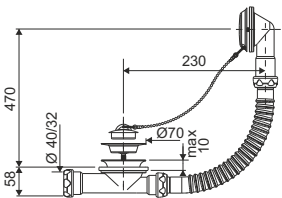

Ref.	Cod.		€	
I-84	660449	Válvula bañera salida horizontal extraplana, orientable con tuerca Ø40 mm	9,65	40

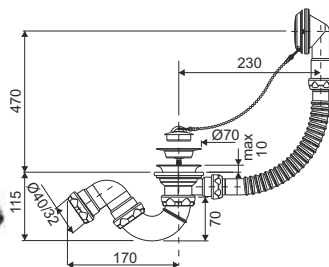

Ref.	Cod.		€	
I-90	660455	Válvula sifónica bañera salida orientable con tuerca Ø40 mm, con rebosadero extensible (S)	10,75	25

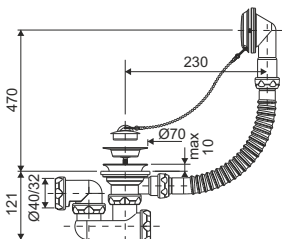



Ref.	Cod.		€	
I-91	660456	Válvula sifónica bañera autolimpiante, salida horizontal con tuerca Ø40 mm, con rebosadero extensible	10,60	25



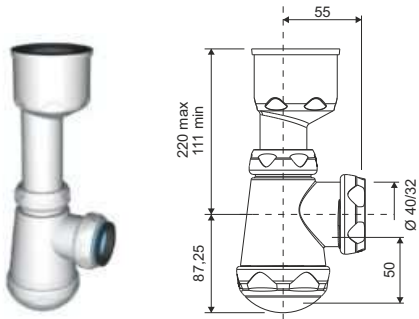

URINARIO





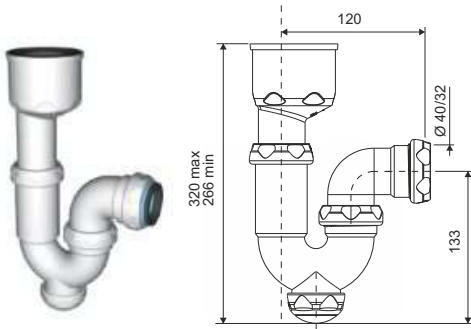

Ref.	Cod.		€	
I-250	661161	Sifón botella extensible, salida horizontal Ø40 mm, con reductora Ø32 mm, acople a urinario	14,55	35

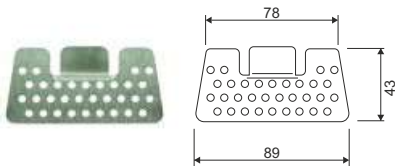

Ref.	Cod.		€	
I-251	661162	Sifón curvo extensible, salida horizontal Ø40 mm, con reductora Ø32 mm, acople a urinario	14,55	30



Ref.	Cod.		€	
	660531	Rejilla urinario. Fabricada en acero inoxidable	1,45	10

TUBOS FLEXIBLES

Tª trabajo: -5% +60°C

TODOS LOS MODELOS INCLUYEN JUNTA PLANA Y EMBELLECEDOR

Mat.	Ref.	Cod.	€			
	PP	I-164	30603	Tubo flexible BLANCO lavabo-bidet 1"1/4 Ø32-40 Lmax = 72 cm, Lmin = 30 cm	3,25	50
	PP	I-165	30604	Tubo flexible BLANCO fregadero 1"1/2 Ø40-50 Lmax = 72 cm, Lmin = 30 cm	3,40	50
	PP	I-173	30651	Tubo flexible BLANCO fregadero 1"1/2 Ø32-40 Lmax = 72 cm, Lmin = 30 cm	3,60	50
	PP	I-166	30605	Tubo flexible CROMADO lavabo-bidet 1"1/4 Ø32-40 Lmax = 72 cm, Lmin = 30 cm	7,45	50
	PP	I-167	30606	Tubo flexible CROMADO fregadero 1"1/2 Ø40-50 Lmax = 72 cm, Lmin = 30 cm	7,45	50
	PP	I-168	30610	Tubo flexible BLANCO lavabo-bidet 1"1/4 Ø32-40 , con tuerca METÁLICA. Lmax = 72 cm, Lmin = 30 cm	3,60	50
	PP	I-169	30609	Tubo flexible BLANCO fregadero 1"1/2 Ø40-50, con tuerca METÁLICA. Lmax = 72 cm, Lmin = 30 cm	3,70	50

TUBOS FLEXIBLES EQUIPAMIENTO WC

Tª trabajo: -5% +60°C

TODOS LOS MODELOS INCLUYEN JUNTA PLANA Y EMBELLECEDOR

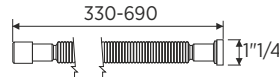

Mat.	Ref.	Cod.		€	
PP	I-172	30634	Tubo flexible BLANCO 1"1/2 Ø32-40 con reductor 1"1/4 Lmax = 69cm, Lmin = 33 cm	5,00	50

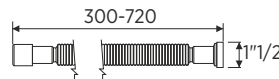
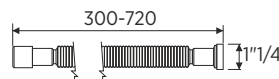
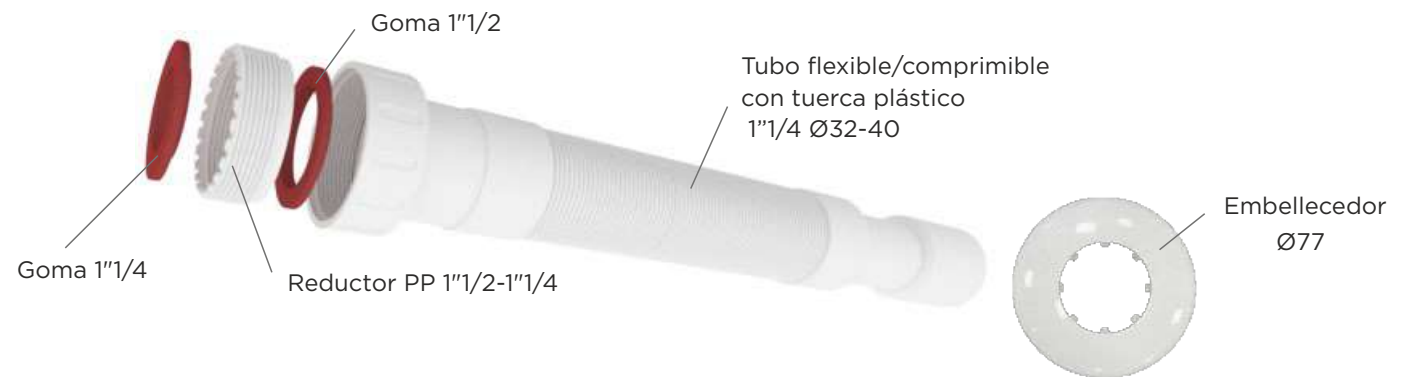

Mat.	Ref.	Cod.		€	
ABS		30637	Tubo flexible BLANCO 1"1/4 Ø32-40. ENCOLABLE.	4,55	50
ABS		30638	Tubo flexible BLANCO 1"1/2 Ø40-50. ENCOLABLE.	4,60	50

*Disponibles convertidores de roscas en página 159.



Ø77



Ø77



Mat.	Ref.	Cod.		€	
PP		30641	Florón embellecedor BLANCO Ø 32	0,80	50

PP		30642	Florón embellecedor BLANCO Ø 40	0,80	50
----	--	--------------	---------------------------------	------	----

Mat.	Ref.	Cod.		€	
PP		30643	Florón embellecedor CROMO Ø 32	1,60	50

PP		30644	Florón embellecedor CROMO Ø 40	1,60	50
----	--	--------------	--------------------------------	------	----

Mat.	Ref.	Cod.		€	
		30645	Junta para flexible 1" 1/4	0,60	50

		30646	Junta para flexible 1" 1/2	0,60	50
--	--	--------------	----------------------------	------	----

RECAMBIOS



PIEZAS DE RECAMBIO SIFONES Y VÁLVULAS



INOX



PRODUCTO
NUEVO



INOX



INOX



INOX



Cod.		€	Embalaje	
660502	Rejilla filtro INOX para válvula cesta 80 pasador metálico.	5,80	Granel	10/bolsa
660502.NE	Rejilla filtro INOX para válvula cesta 80 pasador metálico. Acabado Negro	9,20	Granel	10/bolsa
660502.GR	Rejilla filtro INOX para válvula cesta 80 pasador metálico. Acabado Grafito	9,20	Granel	10/bolsa
660502.ORO	Rejilla filtro INOX para válvula cesta 80 pasador metálico. Acabado Oro	9,20	Granel	10/bolsa

Cod.		€	Embalaje	
660503	Rejilla filtro INOX para válvula cesta Ø80 con pasador plástico	3,90	Granel	10/bolsa

Cod.		€	Embalaje	
660504	Rejilla filtro INOX para válvula cesta Ø60 tipo araña	3,70	Granel	10/bolsa

Cod.		€	Embalaje	
660505	Rejilla filtro INOX para válvula cesta Ø80 tipo araña	3,90	Granel	10/bolsa

PIEZAS DE RECAMBIO

SIFONES Y VÁLVULAS

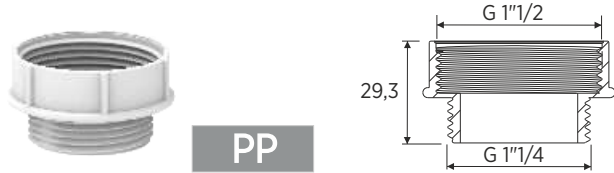

PP

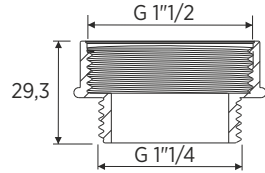

PP

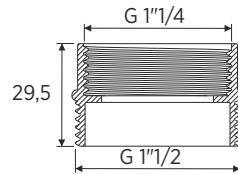

PP

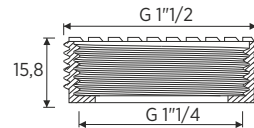

PVC

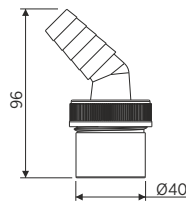

PVC

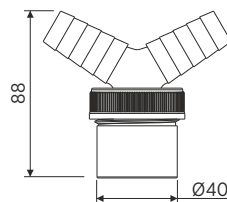

ABS

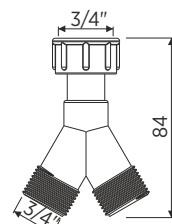

PVC

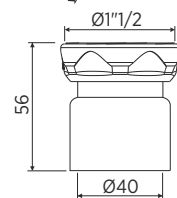

Cod.	€	Embalaje
30614	1,05	Granel 10/bolsa

Adaptador convertidor PP roscas macho 1"1/4 - hembra 1"1/2

Cod.	€	Embalaje
30615	1,05	Granel 10/bolsa

Adaptador convertidor PP roscas macho 1"1/2 - hembra 1"1/4

Cod.	€	Embalaje
30628	1,05	Granel 10/bolsa

Reductor PP 1"1/2 a 1"1/4

Ref.	Cod.	€	Embalaje
I-156	660500	2,50	Bolsa 10/bolsa

Conexión PVC Ø40 (encolar) con una toma para electrodomésticos

Ref.	Cod.	€	Embalaje
I-157	660501	3,25	Bolsa 10/bolsa

Conexión PVC Ø40 (encolar) con toma doble para electrodomésticos

Ref.	Cod.	€	Embalaje
I-268	660516	3,00	Bolsa 10/bolsa

Racor doble lavadora lavavajillas 3/4"

Ref.	Cod.	€	Embalaje
I-140	660484	1,80	Bolsa 10/bolsa

Enlace mixto PVC 1"1/2x40 (encolar)



PIEZAS DE RECAMBIO SIFONES Y VÁLVULAS

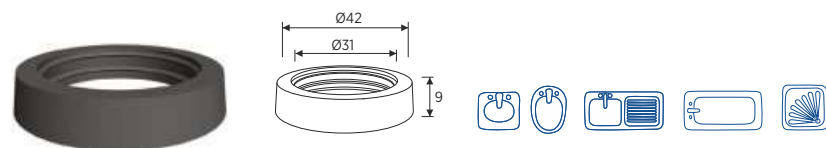

Cod.		€	Embalaje	
660315	Junta cónica reductora Ø32	0,55	Granel	25/bolsa

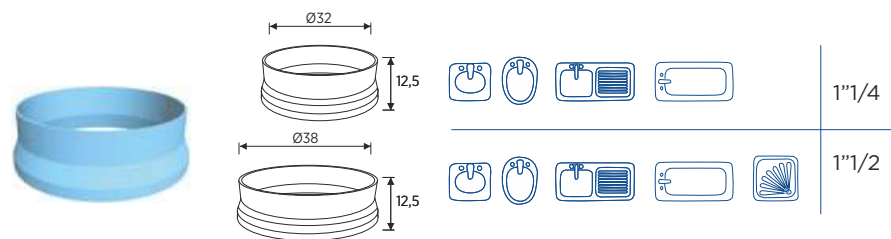

Cod.		€	Embalaje	
660332	Junta cónica (PE) SOFT	0,55	Granel	50/bolsa
660314		0,55	Granel	50/bolsa

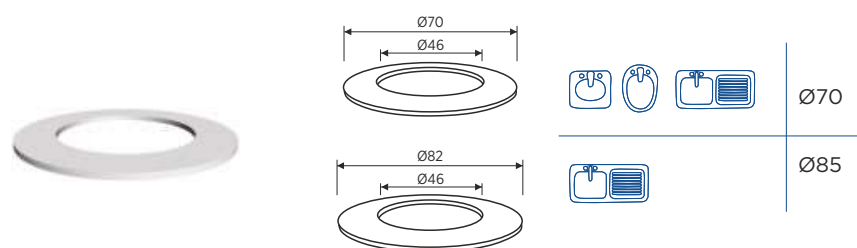

Cod.		€	Embalaje	
660334	Junta plana superior válvula	0,55	Granel	50/bolsa
660339		0,70	Granel	50/bolsa

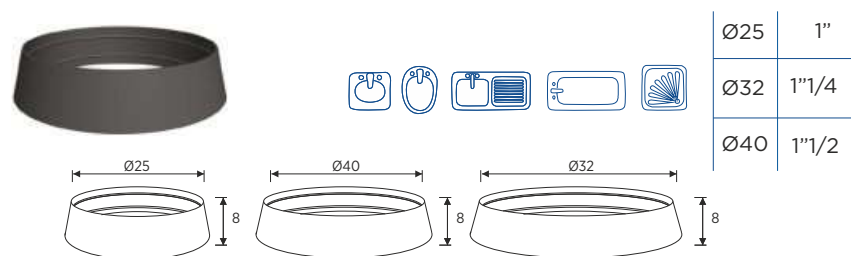

Cod.		€	Embalaje	
660311	Junta cónica	0,50	Granel	50/bolsa
660310		0,50	Granel	50/bolsa
660320		0,50	Granel	50/bolsa

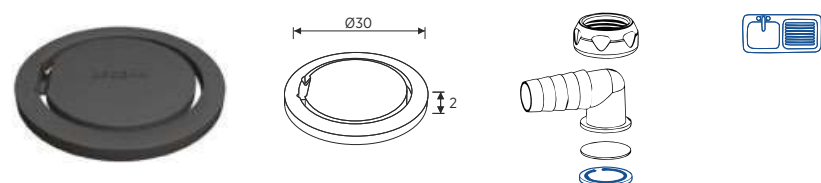

Cod.		€	Embalaje	
660344	Junta retención toma auxiliar	0,55	Granel	50/bolsa

PIEZAS DE RECAMBIO

SIFONES Y VÁLVULAS

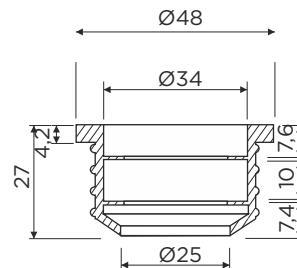
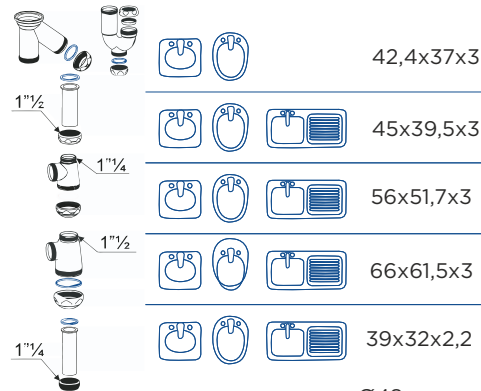
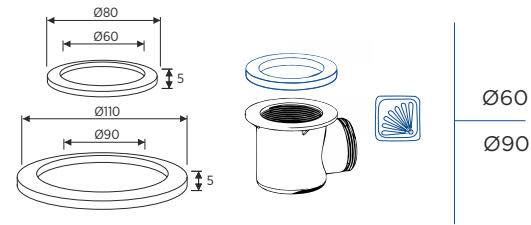
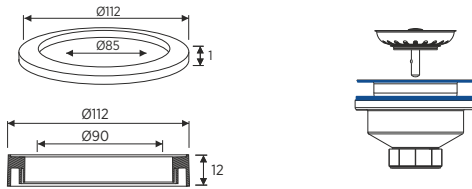
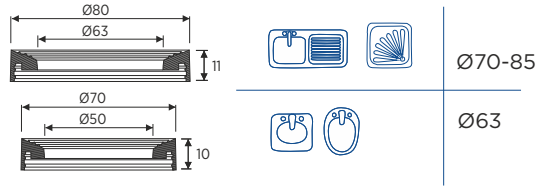

Cod.		€	Embalaje	
660340	Junta inferior válvula EASYFIT	0,75	Granel	25/bolsa
660305	Junta inferior válvula EASYFIT	0,80	Granel	25/bolsa

Cod.		€	Embalaje	
660336	Junta blanca válvula fregadero ref. 661164, 661165	0,90	Granel	25/bolsa
660335	Junta válvula fregadero ref. 661164, 661165	1,35	Granel	25/bolsa

Cod.		€	Embalaje	
660396	Junta plana válvula sifónica ducha	0,95	Granel	10/bolsa
660380		1,15	Granel	10/bolsa

Cod.		€	Embalaje	
660325	Junta plana	0,50	Granel	25/bolsa
660331		0,55	Granel	25/bolsa
660312		0,50	Granel	25/bolsa
660322		0,55	Granel	25/bolsa
660318		0,50	Granel	25/bolsa

Cod.		€	Embalaje	
30635	Goma unión tubo 40 x 26/32	1,25	Granel	25/bolsa



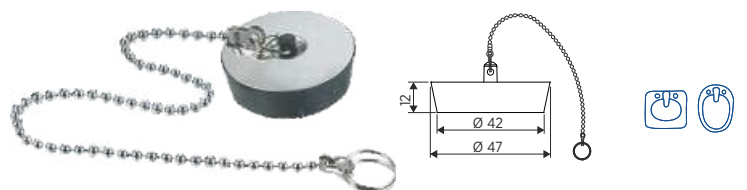

L=250mm



Cod.	€	Embalaje	
660491	2,35	Bolsa	10/bolsa

Conjunto tapón PVC con cubierta INOX y cadenilla 250 mm



L=380mm



Ref.	Cod.	€	Embalaje	
I-145	660489	2,25	Bolsa	25/bolsa

Tapón válvulas con cadena y anillas

L=250mm



I-146	660490	1,85	Bolsa	25/bolsa
-------	---------------	------	-------	----------



L=380mm



Ref.	Cod.	€	Embalaje	
I-162	660271	1,60	Granel	25/bolsa

Cadena con dos anillas

L=250mm



I-163	660301	1,30	Granel	25/bolsa
-------	---------------	------	--------	----------

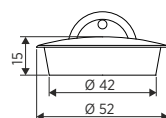

Cod.	€	Embalaje	
660337	0,80	Granel	25/bolsa

Tapón válvula

PIEZAS DE RECAMBIO

SIFONES Y VÁLVULAS



				Ø70
				Ø85



	Ø70
	Ø85
	Ø115



		M12x36
--	--	--------



		M6x35		
		M6x45		
		M6x55		
				M6x65



		1"			
				1"1/4	
					1"1/2



			1"1/2
			1"1/4
			Ø50

Cod.		€	Embalaje	
660333	Rejilla inoxidable	1,05	Granel	10/bolsa
660338		1,55	Granel	10/bolsa

Cod.		€	Embalaje	
660370	Rejilla inoxidable ducha	1,25	Granel	10/bolsa
660363		1,30	Granel	10/bolsa
660373		1,85	Granel	10/bolsa

Cod.		€	Embalaje	
30613	Tornillo largo válvula cesta para fregaderos sintéticos	1,85	Granel	10/bolsa

Cod.		€	Embalaje	
660364	Tornillo inoxidable	0,85	Granel	10/bolsa
660381		0,85	Granel	10/bolsa
660365		0,85	Granel	10/bolsa
660306		0,95	Granel	10/bolsa

Cod.		€	Embalaje	
660346	Tuerca	0,70	Granel	10/bolsa
660309		0,80	Granel	10/bolsa
660316		0,80	Granel	10/bolsa

Cod.		€	Embalaje	
660323	Tapón registro sifones	0,85	Granel	10/bolsa
660313		0,90	Granel	10/bolsa
660326		1,20	Granel	10/bolsa



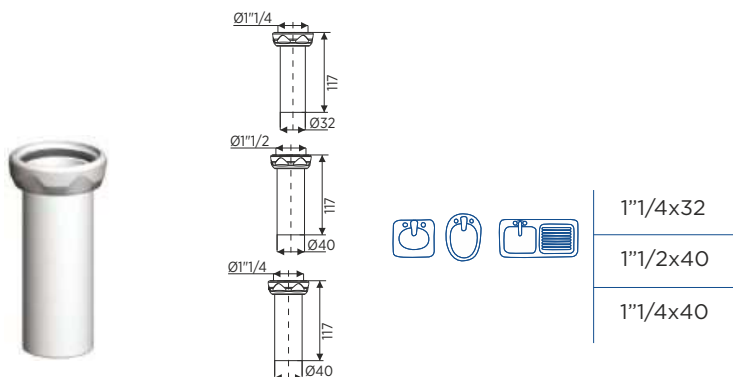

1"1/4x32
1"1/2x40
1"1/4x40

Ref.	Cod.		€	Embalaje	
I-133	660477	Racor con valona y tuerca loca	1,95	Bolsa	1/bolsa
I-132	660476		1,95	Bolsa	1/bolsa
I-260	660508		2,20	Bolsa	1/bolsa

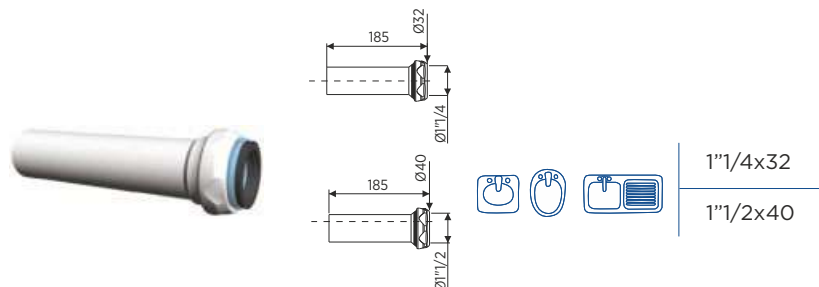

1"1/4x32
1"1/2x40

Ref.	Cod.		€	Embalaje	
I-160	660463	Alargadera con una entrada roscada	2,20	Bolsa	1/bolsa
I-142	660486		2,25	Bolsa	1/bolsa

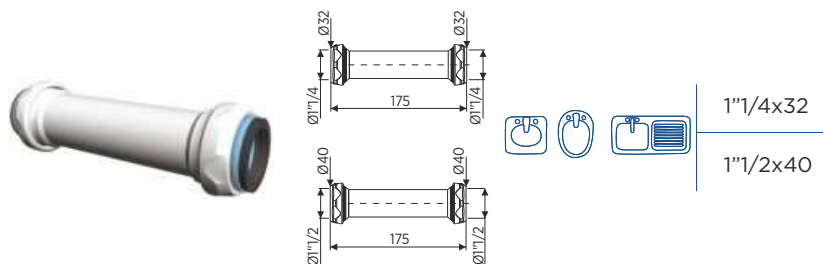

1"1/4x32
1"1/2x40

Ref.	Cod.		€	Embalaje	
I-139	660483	Alargadera dos entradas roscadas	2,35	Bolsa	1/bolsa
I-141	660485		2,45	Bolsa	1/bolsa

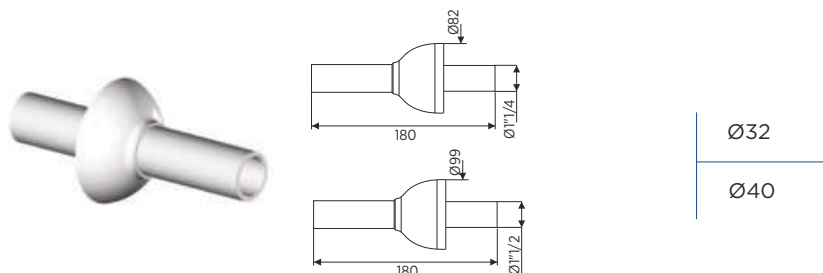

Ø32
Ø40

Ref.	Cod.		€	Embalaje	
I-154	660498	Alargadera acoplamiento a pared con plafón embellecedor	2,20	Bolsa	1/bolsa
I-155	660499		2,35	Bolsa	1/bolsa

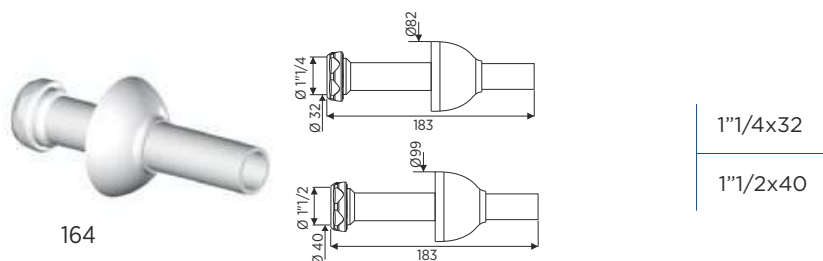

1"1/4x32
1"1/2x40

Ref.	Cod.		€	Embalaje	
I-152	660496	Alargadera acoplamiento a pared con plafón embellecedor y con una entrada roscada	2,45	Bolsa	1/bolsa
I-153	660497		2,55	Bolsa	1/bolsa

PIEZAS DE RECAMBIO

SIFONES Y VÁLVULAS

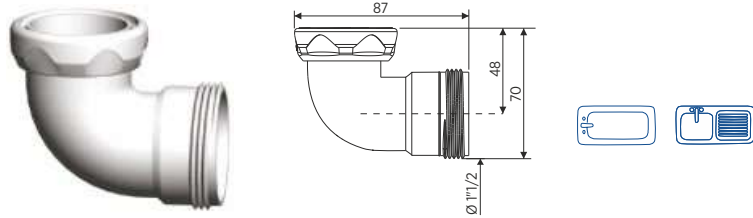

Ref.	Cod.		€	Embalaje	
I-136	660480	Codo rosca una entrada, con valona y tuerca loca	1,65	Bolsa	1/Bolsa

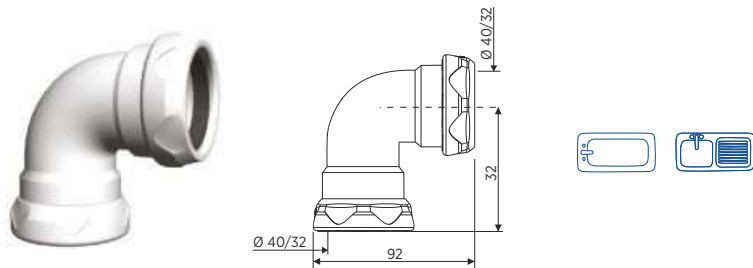

Ref.	Cod.		€	Embalaje	
I-137	660481	Codo para tubos dos entradas roscadas 1" 1/2, con reductora Ø32	2,35	Bolsa	1/Bolsa

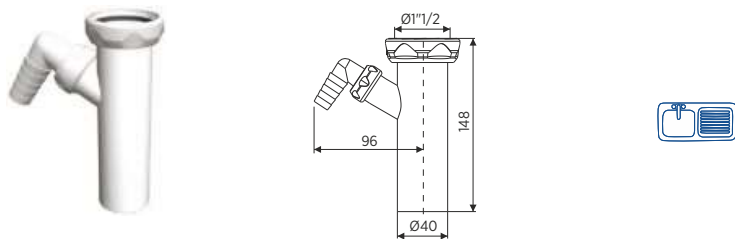

Ref.	Cod.		€	Embalaje	
I-130	660474	Racor con valona y tuerca loca 1" 1/2, con una toma auxiliar	2,60	Bolsa	1/Bolsa

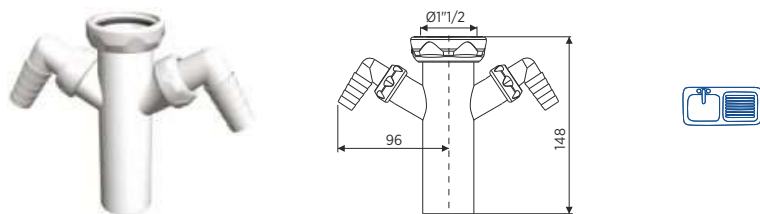

Ref.	Cod.		€	Embalaje	
I-131	660475	Racor con valona y tuerca loca 1" 1/2, con dos tomas auxiliares	2,80	Bolsa	1/Bolsa

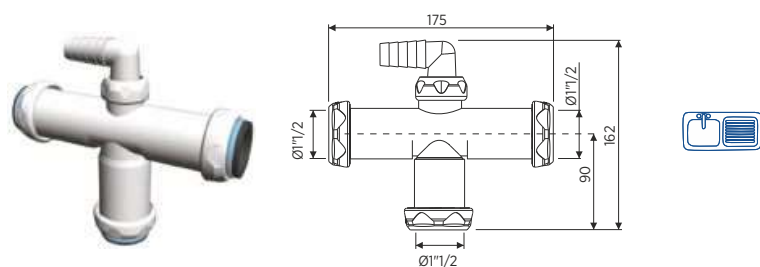

Ref.	Cod.		€	Embalaje	
I-138	660482	"T" con entradas roscadas y toma auxiliar roscada	3,65	Bolsa	1/Bolsa



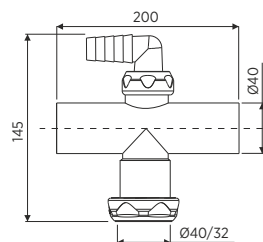

Ref.	Cod.		€	Embalaje	
I-151	660495	"T" lisa con toma auxiliar y tuerca 1" 1/2	4,15	Bolsa	1/Bolsa

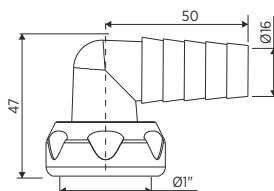

Ref.	Cod.		€	Embalaje	
I-149	660493	Codo toma auxiliar con tuerca	1,40	Bolsa	1/Bolsa

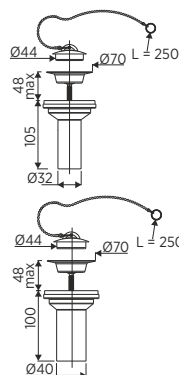

Ø32x70

Ø40x70

Ref.	Cod.		€	Embalaje	
I-143	660487	Válvula extensible lavabo-bidet	4,35	Bolsa	1/Bolsa
I-144	660488		4,50	Bolsa	1/Bolsa

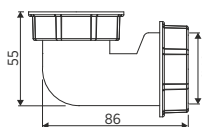

Ref.	Cod.		€	Embalaje	
I-150	660494	Codo extraplano horizontal 1"1/2x40	1,70	Bolsa	1/Bolsa

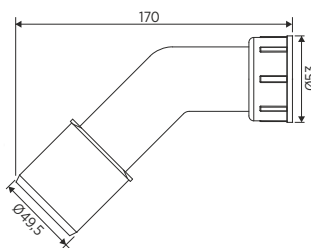

Ref.	Cod.		€	Embalaje	
I-271	660519	Tubo conexión acodado orientable 1"1/2x50 encolable	1,75	Bolsa	1/Bolsa

PRESENTACIÓN DE PRODUCTO



Caja individual

Embalaje disponible para
 varios de nuestros productos



Bolsa

Embalaje disponible para
 varios de nuestros productos

PRESENTACIÓN DE PRODUCTO
EXPOSITORES



Expositor de metacrilato descargadores y grifos

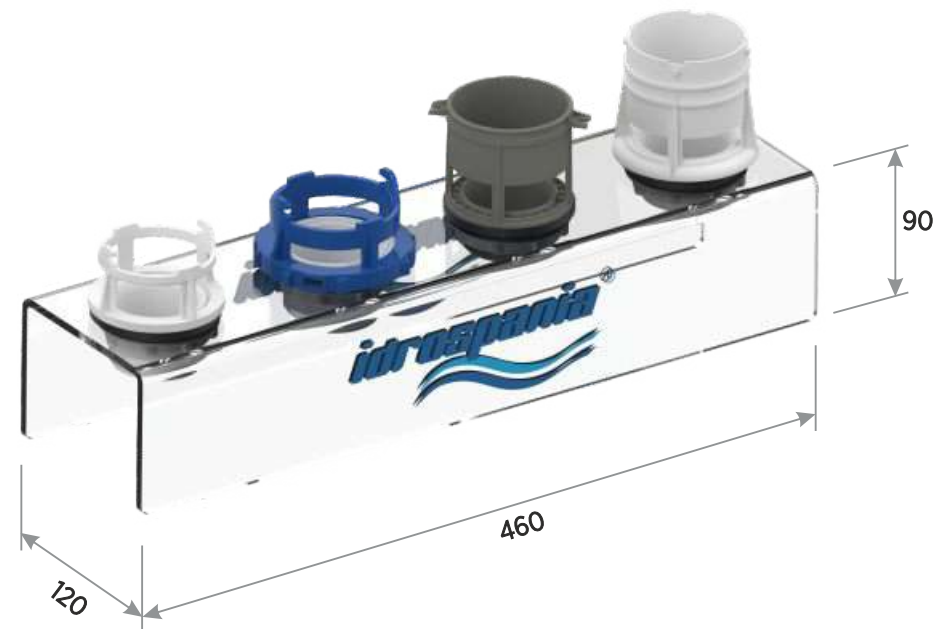

Expositor bases descargadores



Expositor cisternas
Consultar condiciones



Expositor pulsadores cisternas empotradas
Consultar condiciones

PRESENTACIÓN DE PRODUCTO

EXPOSITORES

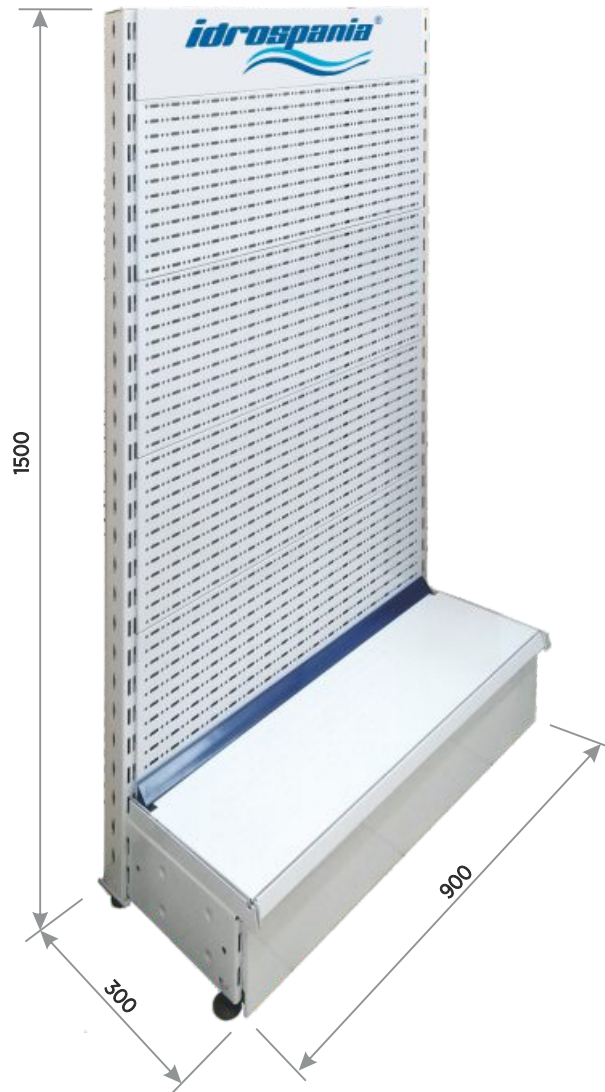

Expositor metálico
Consultar condiciones

EXPOSITOR BOX



Práctico, funcional y ahora más eficiente. Nuestro expositor BOX es la solución perfecta para presentar productos como **mecanismos de descarga, flotadores y asientos de inodoro** de forma ordenada y visualmente atractiva en tienda. A partir de 2025, el expositor se **envía desmontado**, lo que permite un transporte más cómodo y optimizado. Su montaje es sencillo e intuitivo, con instrucciones incluidas.





Expositor de conjuntos higiénicos

CONDICIONES GENERALES

PRECIOS

Los precios reflejados en nuestra tarifa son los recomendados de venta al público y expresados en euros.

Precios válidos salvo error tipográfico.

Este catálogo/tarifa anula a los anteriores.

Idrosponia se reserva el derecho de poder cambiar su política de precios en cualquier momento con su correspondiente preaviso.

IMPUESTOS

Serán aplicados en factura, sobre los precios indicados en nuestra tarifa, los impuestos pertinentes de acuerdo con la ley vigente.

PEDIDOS

Los pedidos deberán ser remitidos por escrito, ello supone la aceptación por parte del cliente de todas las condiciones generales de venta.

ANULACIONES DE PEDIDOS

Las anulaciones al igual que los pedidos deberán ser remitidas por escrito, no admitiendo las mismas cuando la expedición del material haya sido realizada.

PORTES PAGADOS

Para los pedidos por importe superior a **350 euros** (base imponible) para península, **500 euros** para Baleares y **1.000 euros** para las Islas Canarias y Andorra, el transporte será por cuenta de IDROSPANIA.

EXPEDICIONES

La mercancía viaja por cuenta y riesgo del comprador.

EMBALAJES

El material se servirá en la forma de embalaje establecida por IDROSPANIA en cada una de la forma reflejada en nuestros códigos del catalogo/tarifa vigente.

PLAZOS DE ENTREGA

Los plazos de entrega establecidos se consideran a modo orientativo, sin aceptar de modo alguno, reclamaciones por algún posible retraso del envío.

GARANTÍA

El periodo de garantía de nuestros productos es de 3 años, desde la fecha de compra del comprador, siempre y cuando el material haya sido mantenido e instalado de forma correcta con la normativa vigente.

Queda limitada la reposición de material que nuestro departamento de control de calidad no considere como defectuosas.

Idrosponia no se hace responsable de los daños que directa o indirectamente pudieran dar lugar los defectos en sus productos, si los mismos han sido manipulados o si se utilizan siliconas o cualquier otro tipo de sellador industrial que puedan dañar a nuestros productos.

CONDICIONES DE PAGO

El pago será efectuado en las condiciones pactadas con el comprador y en los plazos estipulados con el mismo.

DEVOLUCIONES DE MATERIAL POR ACUERDOS COMERCIALES

Las devoluciones de material, deberán realizarse a través de nuestros agentes comerciales bajo la autorización y condiciones pactadas. No se admiten devoluciones de material de producto descatalogado sea cual fuere su estado.

RESERVA DE MODIFICACIÓN

IDROSPANIA se reserva el derecho de poder cambiar sin previo aviso, el diseño de todos sus productos.

COMPETENCIA JURÍDICA

Ambas partes se someten a la competencia de los Tribunales y Juzgados de Castellón.

ÍNDICE POR CÓDIGO

CÓD.	PÁG.	€		EAN
20100	57	11,55	45	8437012168046
20101	57	12,60	27	8437012168701
20200	60	11,85	50	8437012168053
20201	60	13,05	27	8437012168718
20203	60	12,40	50	8436613910429
20300	62	6,50	65	8437012168084
20301	62	6,80	60	8437012168091
20400	63	9,10	55	8437012168114
20401	63	9,40	45	8437012168138
20600	61	11,25	40	8437012762107
20601	61	12,35	21	8437012762114
20603	61	11,85	40	8436590212837
20800	58	11,25	35	8437012762732
20801	58	12,35	27	8437012762794
20803	58	11,85	35	8436590212875
21100	55	15,00	45	8437012762084
21101	55	16,10	27	8437012762077
21101.1	55	16,10	81	
21103	55	15,55	45	8436590216590
21300	56	14,05	35	8437012763036
21301	56	15,10	21	8437012763043
21301.1	56	15,10	84	
21303	56	14,55	35	8436613910412
21400	59	14,50	50	8437012764323
21401	59	15,55	24	8437012764514
21600	54	16,20	45	8437012764798
21601	54	17,30	27	8437012764866
21601.1	54	17,30	81	
22010	41	17,65	18	8437012168206
22011	41	15,15	25	8437012168220
22014	41	21,75	20	8437012760097
25010	44	11,65	22	8436590219652
27012	43	6,70	45	8437012168503
27013	43	5,00	50	8437012168275
28001	82	6,25	60	8437012168527
28002	82	6,95	50	8437012168541
28003	82	10,65	40	8437012168558
28100	82	15,65	25	8437012168350
28101	82	17,35	25	8437012168381
30000	106	1,95	25	8437012760349

CÓD.	PÁG.	€		EAN
30001	106	2,35	25	8437012760356
30002	106	1,45	25	8437012760363
30003	106	2,60	25	8437012760370
30004	106	1,85	25	8437012760387
30005	106	2,60	25	8437012760394
30006	107	1,05	25	8437012760400
30007	107	2,10	25	8437012762664
30009	107	1,80	25	8437012765283
30010	107	1,30	25	8437012765290
30011	92	4,10	—	8436590216217
30015	106	3,50	25	8436590219164
30050	104	1,95	10	8437012760417
30051	104	4,30	10	8437012760424
30052	104	2,90	10	8437012760431
30053	104	1,75	10	8437012760448
30100	105	0,70	50	8437012760455
30101	104	1,60	25	8437012760462
30102	104	1,05	25	8437012760479
30104	101	2,55	25	8437012760486
30109	101	1,35	25	8436590216415
30200	98	1,40	50	8437012760493
30201	102	1,75	10	8437012760509
30202	102	0,85	25	8437012760516
30204	102	1,05	10	8437012760523
30207	103	1,30	50	8437012760554
30208	99	1,30	25	8437012760561
30209	99	1,20	25	8437012760578
30210	98	1,30	100	8437012760585
30211	98	1,25	100	8437012760592
30212	98	1,25	50	8437012760608
30213	100	2,25	50	8437012760615
30214	100	1,90	50	8437012760622
30215	103	0,65	50	8437012760639
30216	99	1,95	25	8437012760646
30218	98	1,20	100	8437012760660
30219	100	2,10	50	8437012760677
30220	100	1,95	50	8437012760684
30221	101	1,70	25	8437012760691
30222	100	1,75	50	8437012760707
30223	98	1,35	50	8437012760714

CÓD.	PÁG.	€		EAN
30224	103	1,35	50	8436613911167
30226	101	3,05	25	8437012760745
30230	102	1,80	10	8437012763456
30231	99	1,65	50	8437012765221
30234	100	2,05	50	8436613911150
30235	103	1,45	50	8436613911198
30237	102	0,85	10	8436613913956
30300	108	5,95	10	8437012760776
30304	110	2,75	10	8437012760814
30305	110	4,50	25	8437012760820
30306	110	4,50	25	8437012760837
30308	110	6,50	25	8437012760851
30309	110	6,95	25	8437012760868
30310	109	4,00	25	8437012762169
30310.NE	109	4,50	25	8436590218013
30314	109	4,00	25	8437012763159
30314.NE	109	4,50	25	8436590218020
30315	109	3,45	25	8437012765344
30317	108	4,30	10	8437012763463
30319	109	1,45	25	8437012763470
30319.NE	109	1,55	25	8436590219171
30321	109	3,35	25	8437012765337
30323	108	18,75	5	8437012765320
30325	108	7,40	10	8437012765313
30330	24	35,85	—	8437012763487
30332	24	48,85	—	8437012763500
30333	24	180,60	—	8437012763517
30339	109	4,00	25	8436613913475
30340	24	44,15	—	8436590215708
30341	24	44,15	—	8436590215715
30342	24	51,30	—	8436590215692
30343	24	51,30	—	8436590215722
30400	105	1,70	50	8437012760875
30402	103	9,15	20	8437012760899
30403	111	17,30	—	8437012763524
30404	111	11,45	—	8437012763531
30405	111	14,75	—	8437012763548
30406	111	9,60	—	8437012763555
30407	111	21,95	—	8437012763562
30408	111	21,95	—	8436590216224

ÍNDICE POR CÓDIGO

CÓD.	PÁG.	€		EAN
30409	111	23,95	—	8436590216231
30410	111	26,80	—	8436590216248
30412	24	29,95	—	8437012765481
30413	24	29,95	—	8437012765498
30416	128	0,70	50	8436590216255
30417	128	0,85	50	8436590216262
30418	128	0,65	50	8436590216279
30419	128	3,20	50	8436590216286
30423	24	14,95	—	8436590216293
30425	72	6,40	—	8436590219669
30426	72	8,80	—	8436590219676
30426.NE	72	12,50	—	8436590219683
30427	72	8,90	—	8436590219690
30431	99	3,60	25	8436590215241
30432	99	4,20	25	8436590215258
30433	24	18,10	—	8436590216309
30436	24	15,35	—	8436590216316
30453	23	19,40	—	8436613912386
30459	72	4,90	—	8436590219720
30460	73	8,00	—	8436590219737
30460.NE	73	9,10	—	8436590219744
30461	73	14,95	—	8436590219751
30461.NE	73	17,20	—	8436590219768
30462	73	8,05	—	8436590219775
30463	72	16,55	—	8436590219706
30463.NE	72	32,45	—	8436590218044
30480	23	14,60	—	8436590217801
30481	23	13,50	—	8436590217818
30482	23	7,80	—	8436590217825
30483	23	9,05	—	8436590217849
30484	23	10,75	—	8436590217832
30485	23	8,80	—	8436590217856
30486	23	10,50	—	8436590217863
30487	23	10,50	—	8436590217870
30488	23	3,30	—	8436590217887
30489	23	4,30	—	8436590217894
30490	23	4,40	—	8436590217900
30491	23	6,60	—	8436590217917
30492	23	11,55	—	8436590217924
30493	23	5,25	—	8436590217931

CÓD.	PÁG.	€		EAN
30494	23	5,25	—	8436590217948
30495	23	5,25	—	8436590217955
30497	23	12,25	—	8436613910399
30498	23	9,50	—	8436613910405
30499	23	7,40	—	8436613910382
30500	94	5,20	36	8437012760905
30501	94	4,65	36	8437012760912
30502	94	5,20	36	8437012760929
30503	94	4,65	36	8437012760936
30504	95	6,05	36	8437012760943
30505	95	5,65	36	8437012760950
30506	95	6,05	36	8437012760967
30507	95	5,65	36	8437012760974
30508	96	4,35	30	8437012760110
30509	96	4,35	30	8437012760127
30510	92	15,05	10	8437012760981
30511	93	11,85	15	8437012760998
30512	96	5,90	22	8437012760066
30513	93	20,50	10	8437012762695
30514	92	13,95	10	8437012763579
30521	93	15,65	15	8437012764637
30522	93	20,30	10	8437012764644
30523	92	14,60	10	8437012764897
30524	93	16,15	15	8437012764903
30526	92	34,10	10	8436590219133
30527	93	17,10	10	8436613910443
30528	96	10,65	18	8436613910740
30529	92	22,70	5	8436613910757
30530	92	22,10	5	8436613913345
30531	93	9,95	—	8436613916179
30600	118	37,05	—	8437012761001
30600.BLM	124	67,10	—	8437012766143
30600.BRV	125	60,40	—	8437012766082
30600.CO	124	60,40	—	8437012765917
30600.NE	124	67,10	—	8437012765870
30600.NI	125	60,40	—	8437012765887
30600.ORO	125	60,40	—	8437012766075
30600.Z	118	32,35	—	8436590216385
30602	119	22,65	—	8437012761018
30602.NE	119	28,70	—	8436613910603

CÓD.	PÁG.	€		EAN
30602.Z	119	19,45	—	8436590216392
30602.Z.NE	119	23,75	—	8436613910610
30603	154	3,25	50	8437012760004
30604	154	3,40	50	8437012760011
30605	154	7,45	50	8437012760028
30606	154	7,45	50	8437012760035
30607	115	14,05	50	8437012761025
30608	115	15,10	50	8437012761032
30609	154	3,70	50	8437012760042
30610	154	3,60	50	8437012760059
30611	114	14,30	50	8437012762176
30611.BLM	122	24,20	50	8437012766150
30611.BRV	123	24,20	50	8437012766105
30611.CO	122	24,20	50	8437012765931
30611.NE	122	25,10	50	8437012765924
30611.NI	123	24,20	50	8437012765948
30611.ORO	123	24,20	50	8437012766099
30612	116	17,05	50	8437012762183
30613	163	1,85	10	8437012763586
30614	159	1,05	10	8437012765443
30615	159	1,05	10	8437013765450
30616	107	3,60	25	8437012765306
30617	105	1,20	50	8437012765238
30618	105	1,20	50	8437012765245
30619	105	1,15	50	8437012765252
30620	105	1,15	50	8437012765269
30621	105	2,40	50	8437012765276
30621.NE	105	2,70	50	8436613916285
30622	118	48,85	—	8437012764521
30624	114	11,30	50	8437012764545
30625	116	18,20	50	8437012764552
30628	159	1,05	10	8436590216323
30629	128	5,50	50	8436590216330
30629.BLM	128	6,85	50	8436590219355
30629.BRV	128	6,85	50	8436590219348
30629.CO	128	6,85	50	8436590219362
30629.NE	128	8,95	50	8436590216347
30629.NI	128	6,85	50	8436590219386
30629.ORO	128	6,85	50	8436590219379
30632	73	15,05	—	8436613910948

CÓD.	PÁG.	€		EAN
30632.NE	73	21,95	_	8436613911396
30634	155	5,00	50	8436590216439
30635	161	1,25	25	8436590216422
30636	118	72,35	_	8436590217269
30637	155	4,55	50	8436590218037
30638	155	4,60	50	8436613910306
30641	156	0,80	50	8436613910450
30642	156	0,80	50	8436613910467
30643	156	1,60	50	8436613910474
30644	156	1,60	50	8436613910481
30645	156	0,60	50	8436613910498
30646	156	0,60	50	8436613910504
30647	120	18,40	25	8436613910764
30647.BLM	126	20,50	_	8436613916292
30647.NE	126	21,50	_	8436613916308
30648	120	9,80	50	8436613910771
30649	116	13,90	50	8436613910788
30650	115	14,95	50	8436613910795
30651	154	3,60	50	8436613912287
30652.BLM	126	21,50	_	8436613916315
30652.NE	126	22,50	_	8436613916322
30653	105	1,35		8436613916339
30653.BL	105	1,20		8436613916346
30653.NE	105	1,45		8436613916353
30653.ORO	105	2,20		8436613916360
30655	117	12,60	25	8436613916377
30655.BLM	117	13,40	25	8436613916384
30655.NE	117	13,40	25	8436613916391
30700	87	16,40	12	8437012761049
30701	84	33,10	6	8437012764101
30701.1	84	33,10	18	
30702	84	40,90	6	8437012764118
30702.1	84	40,90	18	
30703	85	47,15	6	8437012764125
30703.1	85	47,15	18	
30705	88	3,60	_	8437012764132
30706	88	14,95	_	8437012764149
30707	88	2,35	_	8437012764156
30708	88	2,35	_	8437012764163
30709	85	61,90	6	8437012765207

CÓD.	PÁG.	€		EAN
30709.1	85	61,90	18	
30710	86	54,10	6	8437012765214
30710.1	86	54,10	18	
30711	86	54,10	6	8437012764934
30711.1	86	54,10	18	
30712	88	11,45	_	8436613912102
30713	88	2,25	_	8436613912119
30714	88	2,25	_	8436613912126
30715	87	73,45	5	8436590215920
30716	87	89,20	2	8436590215937
30717	90	57,00	5	8436590215944
30718	90	104,40	5	8436590215951
30719	88	13,80	_	8436590216354
30720	88	13,80	_	8436590216361
30805	23	19,45	_	8436613912133
30806	23	10,00	_	8436613910849
30811	23	5,20	_	8436613912140
30812	23-101	2,05	_	8436613912157
30813	23	6,85	_	8436613913444
30817	14-15-16	6,45	_	8436613916407
30817.NE	14-15-17	6,45	_	8436613916414
30818	77	54,95	_	8436613916254
40000	79	30,25	12	8437012168756
40001	80	19,25	12	8437012761056
40002	80	19,45	12	8437012761063
40100	76	69,20	5	8437012761094
40101	76	72,40	5	8437012761100
40102	76	74,55	5	8437012761117
40103	78	55,05	5	8437012764712
40104	78	50,65	5	8437012764804
40220	14	283,50	_	8436590217177
40230	15	247,85	_	8436590218242
40240	16	192,70	_	8436590218419
40245	16	215,25	_	8436613910801
40320	17	153,35	_	8436590218051
40420	26	396,95	_	8437012765153
40430	26	396,95	_	8437012765146
40500	30	126,00	_	8437012765184
40510	30	156,40	_	8437012765191
40520	30	80,80	_	8436613913451

CÓD.	PÁG.	€		EAN
51010	35	17,80	25	8437012761933
51010.1	35	17,80	75	
51011	35	16,15	32	8437012761940
51012	35	19,35	16	8437012761926
51012.1	35	19,35	64	
51014	35	21,45	25	8437012761957
51015	35	22,90	16	8437012761971
51021	35	17,65	16	8437012762435
51100	51	28,70	16	8437012762190
51200	51	28,95	16	8437012762206
51300	51	23,60	16	8437012762213
51400	51	26,20	16	8437012762220
51714	52	33,45	15	8437012762718
51715	52	34,85	10	8436590217566
53010	37	21,75	25	8437012763203
53010.1	37	21,75	75	
53011	37	19,45	32	8437012763234
53012	37	23,40	16	8437012763210
53012.1	37	23,40	64	
53014	37	25,00	25	8437012763258
53015	37	26,20	16	8437012763265
53021	37	20,95	16	8437012763241
53100	50	34,60	15	8437012763609
53200	50	34,95	16	8437012763616
53300	50	29,50	16	8437012763623
53400	50	32,20	15	8437012763630
53714	52	37,00	15	8437012763647
53715	52	38,80	10	8436590217573
54000	42	16,65	22	8437012764910
54004	42	19,85	22	8437012764927
56010	39	22,40	14	8437012764231
56011	39	20,25	18	8437012764248
56014	39	25,45	14	8437012764255
57010	33	19,90	22	8436613913093
57010.1	33	19,90	66	
57011	33	18,25	27	8436613913109
57012	33	21,50	16	8436613913116
57012.1	33	21,50	64	
57014	33	23,40	22	8436613913123
57015	33	24,95	16	8436613913130

ÍNDICE POR CÓDIGO

CÓD.	PÁG.	€		EAN
57021	33	19,80	16	8436613913468
70021	71	10,20	—	8437012763005
70030	71	7,50	—	8437012763654
70060	71	18,25	—	8437012764309
70070	71	16,05	—	8437012765139
70071.NE	70	86,65	—	8436613910436
70072	70	45,40	—	8437012764972
70074	69	30,40	—	8437012764958
70076	69	43,10	—	8437012764965
70077	66	90,60	—	8437012766044
70077.NE	67	117,55	—	8437012766297
70078	66	139,70	—	8437012766051
70078.ECO	68	90,85	—	8437012766280
70078.NE	67	172,25	—	8437012766273
70110	68	94,90	—	8436613914410
303500	18	28,60	—	8436590217023
303501	18	39,60	—	8436590217030
303502	18	44,00	—	8436590217047
303502.MAG	22	55,05	—	8436613912546
303504	18	37,00	—	8436590217061
303504.MAG	22	48,00	—	8436613912553
303505	18	39,60	—	8436590217320
303506	18	37,00	—	8436590217337
303506.MAG	22	48,00	—	8436613912560
303507.10	18	44,90	—	8436613910375
303508.10	18	44,90	—	8436613910962
303511.10	18	44,90	—	8436613912515
303512.10	18	53,45	—	8436613912522
303513	18	53,45	—	8436613912539
303600	19	28,60	—	8436590217078
303601	19	39,60	—	8436590217085
303602	19	44,00	—	8436590217092
303604	19	37,00	—	8436590217115
303605	19	39,10	—	8436590217344
303606	19	37,00	—	8436590217351
303700	20	28,60	—	8436590217122
303701	20	39,60	—	8436590217139
303701.MAG	22	50,65	—	8436613912577
303702	20	44,00	—	8436590217146
303702.MAG	22	55,05	—	8436613912584

CÓD.	PÁG.	€		EAN
303704	20	37,00	—	8436590217160
303704.MAG	22	48,00	—	8436613912591
303705	20	39,60	—	8436590217368
303706	20	37,00	—	8436590217375
303706.MAG	22	48,00	—	8436613912607
303801	21	77,10	—	8436613912508
660271	162	1,60	25	8437012761162
660301	162	1,30	25	8437012761193
660305	161	0,80	25	8437012761209
660306	163	0,95	10	8437012761216
660309	163	0,80	10	8437012761223
660310	160	0,50	50	8437012761230
660311	160	0,50	50	8437012761247
660312	161	0,50	25	8437012761254
660313	163	0,90	10	8437012761261
660314	160	0,55	50	8437012761278
660315	160	0,55	25	8437012761285
660316	163	0,80	10	8437012761292
660318	161	0,50	25	8437012761308
660320	160	0,50	50	8437012761315
660322	161	0,55	25	8437012761322
660323	163	0,85	10	8437012761339
660325	161	0,50	25	8437012761346
660326	163	1,20	10	8437012761353
660331	161	0,55	25	8437012761360
660332	160	0,55	50	8437012761377
660333	163	1,05	10	8437012761384
660334	160	0,55	50	8437012761391
660335	161	1,35	25	8436613910528
660336	161	0,90	25	8436613910511
660337	162	0,80	25	8437012761407
660338	163	1,55	10	8437012761414
660339	160	0,70	50	8437012761421
660340	161	0,75	25	8437012761438
660341	162	0,55	—	8436613913918
660341.GR	162	0,55	—	8436613913925
660341.NE	162	0,55	—	8436613913932
660341.ORO	161	0,75	—	8437012761438
660344	160	0,55	50	8437012761445
660346	163	0,70	10	8437012761452

CÓD.	PÁG.	€		EAN
660363	163	1,30	10	8436590210482
660364	163	0,85	10	8437012761483
660365	163	0,85	10	8437012761490
660370	163	1,25	10	8437012761506
660373	163	1,85	10	8437012761537
660380	161	1,15	10	8437012761544
660381	163	0,85	10	8437012761551
660396	161	0,95	10	8437012761575
660401	130	6,65	50	8437012168015
660402	130	4,45	80	8437012168022
660403	130	6,65	65	8437012168039
660403.E	130	7,25	60	8436590216095
660404	130	7,45	45	8437012760073
660405	131	7,45	40	8437012168602
660406	131	7,45	35	8437012168060
660407	131	7,95	30	8437012168077
660410.E	135	4,65	60	8436590216101
660411	135	5,40	45	8437012168619
660411.E	135	6,45	45	8436590216118
660412	135	6,50	45	8437012168121
660413	135	5,10	40	8437012761599
660414	135	6,65	35	8437012761605
660419	136	4,75	50	8437012168916
660420.E	136	5,40	45	8436590216125
660421	136	4,95	40	8437012168213
660421.E	136	5,80	40	8436590216132
660422	136	5,90	35	8437012168626
660425	137	10,65	15	8437012168251
660426	137	13,35	14	8437012168268
660427	137	11,40	14	8437012168831
660428	137	14,35	12	8437012168282
660429	138	11,20	15	8437012168299
660430.E	138	13,80	12	8436590216149
660435	132	3,70	65	8437012760141
660435.E	132	4,85	65	8436590216156
660436.E	132	5,05	65	8436590216163
660437.E	139	4,20	65	8436590216170
660438	139	4,55	50	8437012761650
660439	139	4,50	50	8437012168398
660440	138	8,90	40	8437012168404

CÓD.	PÁG.	€		EAN
660445	149	10,00	30	8437012168459
660446	149	9,60	35	8437012168466
660447	148	30,25	18	8437012168473
660448	148	30,50	18	8437012168480
660449	149	9,65	40	8437012168947
660455	149	10,75	25	8437012761704
660456	149	10,60	25	8437012761711
660457	148	31,40	18	8436613913338
660458	148	31,30	18	8436613913482
660462	136	4,80	50	8437012763074
660463	164	2,20	1	8437012168633
660465	143	4,40	50	8437012168657
660466	143	4,45	75	8437012168664
660468	143	4,95	75	8437012168688
660469	143	5,40	75	8437012168695
660470	144	6,75	60	8437012168978
660474	165	2,60	1	8437012761735
660475	165	2,80	1	8437012761742
660476	164	1,95	1	8437012168763
660477	164	1,95	1	8437012761759
660480	165	1,65	1	8437012168855
660481	165	2,35	1	8437012168879
660482	165	3,65	1	8437012168909
660483	164	2,35	1	8437012761766
660484	159	1,80	10	8437012168961
660485	164	2,45	1	8437012168848
660486	164	2,25	1	8437012168862
660487	166	4,35	1	8437012761773
660488	166	4,50	1	8437012168886
660489	162	2,25	25	8437012761780
660490	162	1,85	25	8437012761797
660491	162	2,35	10	8437012765467
660493	166	1,40	1	8437012761810
660494	166	1,70	1	8437012761827
660495	166	4,15	1	8437012761834
660496	164	2,45	1	8437012761841
660497	164	2,55	1	8437012761858
660498	164	2,20	1	8437012168985
660499	164	2,35	1	8437012168992
660500	159	2,50	10	8437012763661

CÓD.	PÁG.	€		EAN
660501	159	3,25	10	8437012763678
660502	158	5,80	10	8437012762336
660502.GR	158	9,20	10	8436613913888
660502.NE	158	9,20	10	8436613913895
660502.ORO	158	9,20	10	8436613913901
660503	158	3,90	10	8437012762343
660504	158	3,70	10	8437012762350
660505	158	3,90	10	8437012762367
660508	164	2,20	1	8437012762398
660513	142	15,65	32	8437012762862
660515	142	18,50	24	8437012762886
660516	159	3,00	10	8437012763685
660518	131	3,85	50	8437012765351
660519	166	1,75	1	8437012765474
660520	132	4,60	85	8437012765368
660521	132	4,65	85	8437012765375
660523	132	4,20	75	8437012765382
660524	132	4,90	85	8437012765399
660525	132	4,35	75	8437012765405
660526	132	4,95	85	8437012765412
660527	131 - 135	4,95	40	8436590215494
660531	152	1,45	10	8436613911174
660532	136	4,15	50	8436613912164
660533	130	5,25	60	8436613912973
660534	142	17,15	32	8436613916421
660535	146	15,65	32	8436613914595
660538	146	15,65	25	8436613914625
660539	146	3,65	25	8436613914632
660539.BLM	146	6,00	25	8436613914694
660539.NE	146	6,00	25	8436613914700
660540	148	28,90	30	8436613916438
660550	140	8,80	_	8436613911013
660551	140	8,80	_	8436613911020
660552	140	8,80	_	8436613911037
660553	140	7,25	_	8436613911044
660554	140	7,25	_	8436613911051
660555	140	7,25	_	8436613911068
660556	140	7,25	_	8436613911075
660557	140	7,40	_	8436613911082
660558	140	7,40	_	8436613911099

CÓD.	PÁG.	€		EAN
660559	140	7,40	_	8436613911105
660560	140	7,40	_	8436613911112
660561	140	7,60	_	8436613911129
660562	140	18,55	_	8436613911136
660563	140	20,50	_	8436613911143
661151	143	6,55	50	8437012168473
661152	143	6,00	55	8437012168480
661154	145	12,35	35	8437012764651
661155	145	11,45	45	8437012764668
661156	145	14,00	30	8437012764675
661157	145	11,45	45	8437012764682
661158	144	6,85	75	8437012765429
661159	144	11,45	36	8437012765436
661161	152	14,55	35	8437012168954
661162	152	14,55	30	8437012761865
661164	134	13,45	50	8437012762893
661164.GR	134	17,80	50	8436613910573
661164.NE	134	17,80	50	8436613910566
661164.ORO	134	17,80	50	8436613910634
661165	134	17,80	30	8437012762909
661165.GR	134	22,90	30	8436613910597
661165.NE	134	22,90	30	8436613910580
661165.ORO	134	22,90	30	8436613910641
661181	138	8,45	22	8437012761872
661205	130	4,65	45	8437012766068



Calidad y confianza

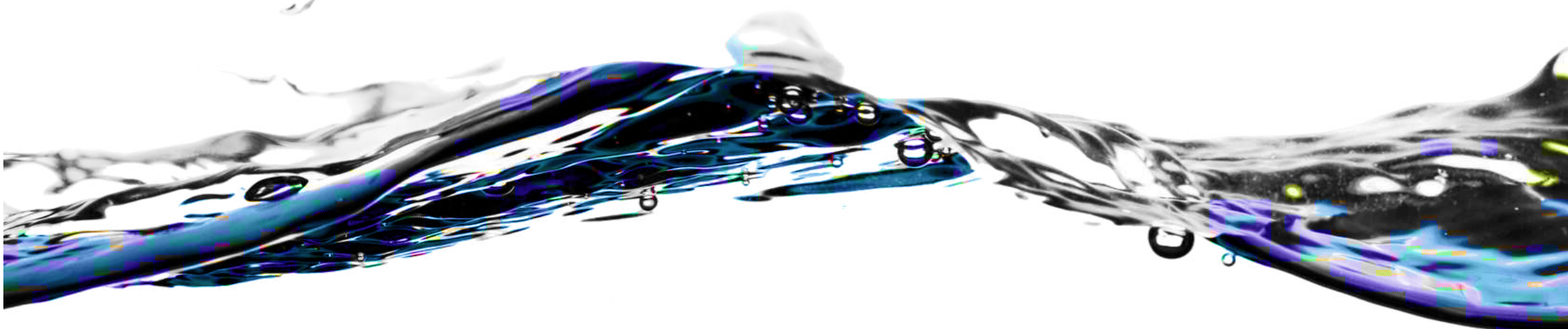

H. & H. Idrospania Technic S.L.
Parque Empresarial Carabona
Avda de L'Argent, Parcela M-3
Apartado de correos 371 • 12530
Burriana • Castellón (SPAIN)

Tel. 964 57 72 20
Fax. 964 59 28 92
idrospania@idrospania.com
www.idrospania.com



CATÁLOGO PDF
ACTUALIZADO



VÍDEO
CORPORATIVO

