

2024-2025 / ESP-ENG-POR

## **Prefacio**

### **Preface**

### Prefácio

**Werku proporciona  
herramientas de calidad  
al precio correcto, sin  
renunciar al diseño y la  
innovación tecnológica.  
Con esta simple filosofía,  
cada día más usuarios  
compran Werku.**

Werku provides quality tools  
at the right price, without  
giving up design and  
technological innovation.  
With this simple philosophy,  
every day more users  
buy Werku.

Werku fornece ferramentas de  
qualidade a um preço justo,  
sem comprometer o desenho  
e a inovação tecnológica.  
Com esta filosofia simples,  
todos os dias mais usuários  
compram Werku.

## **Contenido**

## **Contents**

### Contido

**Herramientas eléctricas**

**Herramientas neumáticas y airless**

**Herramientas manuales**

**Escaleras y plataformas**

**Protección y seguridad**

**Químicos técnicos**

Power tools

Pneumatic and airless tools

Hand tools

Ladders and platforms

Protection and safety

Technical chemicals

Ferramentas elétricas

Ferramentas pneumáticas e airless

Ferramentas manuais

Escadas e plataformas

Proteção e segurança

Químicos técnicos

# Herramientas Eléctricas

## Power Tools

Ferramentas Eléctricas



## Gama Inalámbrica Batería-Cargador Intercambiable

### Interchangeable Battery-Charger Cordless Range

#### Gama Sem Fios Bateria-Carregador Intercambiável

**Cargador WK403480**

**Batería WK403470**

**Taladro atornillador-percutor WK403400**

**Taladro martillo demoledor WK403420**

**Lijadora circular paredes-techos WK403430**

**Lijadora circular paredes WK403440**

**Mezclador pintura-mortero WK403280**

**Atornillador paneles-placas yeso WK403450**

**Amoladora WK403410**

**Sierra sable WK403460**

Charger WK403480

Battery WK403470

Impact-driver drill WK403400

Demolition hammer drill WK403420

Circular wall-ceiling sander WK403430

Circular wall sander WK403440

Paint-mortar mixer WK403280

Drywall panel-board screwdriver WK403450

Grinder WK403410

Reciprocating saw WK403460

Carregador WK403480

Bateria WK403470

Berbequim aparafusador-percussor WK403400

Berbequim martelo demolidor WK403420

Lixadora circular paredes-tetos WK403430

Lixadora circular paredes WK403440

Misturador pintura-argamassa WK403280

Aparafusador painéis-placas gesso WK403450

Rebarbadora WK403410

Serra sabre WK403460



	<b>WK403470</b> 16 / 001-034.000	<b>WK403480</b> 20 / 001-010.000	<b>WK403400</b> 10 / 001-042.000	<b>WK403410</b> 6 / 001-042.000	<b>WK403420</b> 4 / 001-062.000	<b>WK403430</b> 1 / 001-148.000
	9	8	61	48	64	13
	8 424835 011192	8 424835 011208	8 424835 011123	8 424835 011130	8 424835 011147	8 424835 011154



	<b>WK403440</b> 4 / 001-098.000	<b>WK403450</b> 6 / 001-058.000	<b>WK403460</b> 10 / 001-042.000	<b>WK403280</b> 2 / 001-098.000
	18	59	50	32
	8 424835 011161	8 424835 011178	8 424835 011185	8 424835 010744

# Cargador Rápido

## Quick Charger

### Carregador Rápido

**Cuerpo de ABS composite**

**Indicador LED de carga de batería**

**Función de carga inteligente**

**Función de enfriado de cargador y batería**

Composite ABS body

Battery charge LED indicator

Smart charging function

Charger and battery cooling function

Corpo de ABS composite

Indicador LED de carga da bateria

Função de carregamento inteligente

Função de resfriamento do carregador e da bateria



**WK403400**

**WK403410**

**WK403420**

**WK403430**

**WK403440**

**WK403450**

**WK403460**

**WK403280**



**WK403480**  
20 / 001-010.000



60 W - 2.3 A



2 H



CE



8 424835 011208



# Batería Recargable

## Rechargeable Battery

### Bateria Recarregável



- WK403400**
- WK403410**
- WK403420**
- WK403430**
- WK403440**
- WK403450**
- WK403460**
- WK403280**

**Cuerpo de ABS composite**

**Indicador LED de carga de batería**

**Sin efecto memoria ni autodescarga**

**Incluye placa electrónica para la protección contra sobrecargas, sobredescargas, sobrecorrientes y cortocircuitos**

Composite ABS body

Battery charge LED indicator

No memory effect or self-discharge

Includes electronic board for protection against overcharges, overdischarges, overcurrents and short circuits

Corpo de ABS composite

Indicador LED de carga da batería

Sem efeito memória ou autodescarga

Inclui placa eletrônica para proteção contra sobrecargas, sobredescargas, sobrecorrentes e curtos-circuitos



	<b>WK403470</b> 16 / 001-034.000
	20 V = 4 AH LI-ION
	2 H
	CE
	8 424835 011192





# Lijadora Circular Paredes-Techos

## Circular Wall-Ceiling Sander

Lixadora Circular Paredes-Tetos

**Cuerpo de ABS composite y acero carbono forjado**

**Interruptor con botón de funcionamiento continuo**

**Sistema de extracción compatible con aspirador**

**Mango ergonómico y antideslizante**

**Mango auxiliar de soporte**

**Selector de 6 velocidades**

**Sistema integrado de luz LED de visión de 360 grados**

**Fijación del disco con velcro**

**Extensible y plegable**

**Incluye disco microperforado de lijado de 225 mm**

**Incluye manguera de aspiración de 4.5 metros**

**Incluye bolsa de transporte**

Composite ABS and forged carbon steel body

Switch with continuous operation button

Extraction system compatible with vacuum cleaner

Ergonomic and non-slip handle

Support auxiliary handle

6 speed selector

Integrated 360 degrees vision LED light system

Disc fixing with velcro

Extendable and foldable

Includes 225 mm microperforated sanding disc

Includes 4.5-meter suction hose

Includes transportation bag

Corpo de ABS composite e aço carbono forjado

Interruptor com botão de operação contínua

Sistema de extração compatível com aspirador

Cabo ergonômico e antiderrapante

Cabo auxiliar de suporte

Selector de 6 velocidades

Sistema integrado de luz LED de visão de 360 graus

Fixação do disco com velcro









Extensível e dobrável

Inclui disco microperforado de lixado de 225 mm

Inclui mangueira de sucção de 4.5 metros

Inclui bolsa de transporte



	<b>WK400030</b> 2 / 001-118.000
	750 W
	1000-2100 RPM
	6
	225 MM
	1300-1800 MM
	0-90°
	CE
	8 424835 003487



# Lijadora Circular Paredes-Techos

## Circular Wall-Ceiling Sander

Lixadora Circular Paredes-Tetos

**Cuerpo de ABS composite y acero carbono forjado**

**Interruptor con botón de funcionamiento continuo**

**Sistema de auto-extracción integrado compatible con colector de polvo o aspirador**

**Mango ergonómico y antideslizante**

**Mango auxiliar de soporte**

**Selector de 6 velocidades**

**Sistema integrado de luz LED de visión de 360 grados**

**Fijación del disco con velcro**

**Extensible y plegable**

**Incluye disco microperforado de lijado de 225 mm**

**Incluye manguera de aspiración de 1.5 metros**

**Incluye colector de polvo de 20 litros**

**Incluye correa de uso**

**Incluye bolsa de transporte**

Composite ABS and forged carbon steel body

Continuous operation switch

Integrated auto-extraction system compatible with dust collector or vacuum cleaner

Ergonomic and non-slip handle

Support auxiliary handle

6 speed selector

Integrated 360 degrees vision LED light system

Disc fixing with velcro

Extendable and foldable

Includes 225 mm microperforated sanding disc

Includes 1.5-meter suction hose

Includes 20 liter dust collector

Includes use belt

Includes transportation bag

Corpo de ABS composite e aço carbono forjado

Interruptor de operação contínua

Sistema de auto-extração integrado compatível com coletor de pó ou aspirador

Cabo ergonômico e antiderrapante

Cabo auxiliar de suporte

Selector de 6 velocidades

Sistema integrado de luz LED de visão de 360 graus

Fixação do disco com velcro

Extensível e dobrável

Inclui disco microperforado de lixado de 225 mm







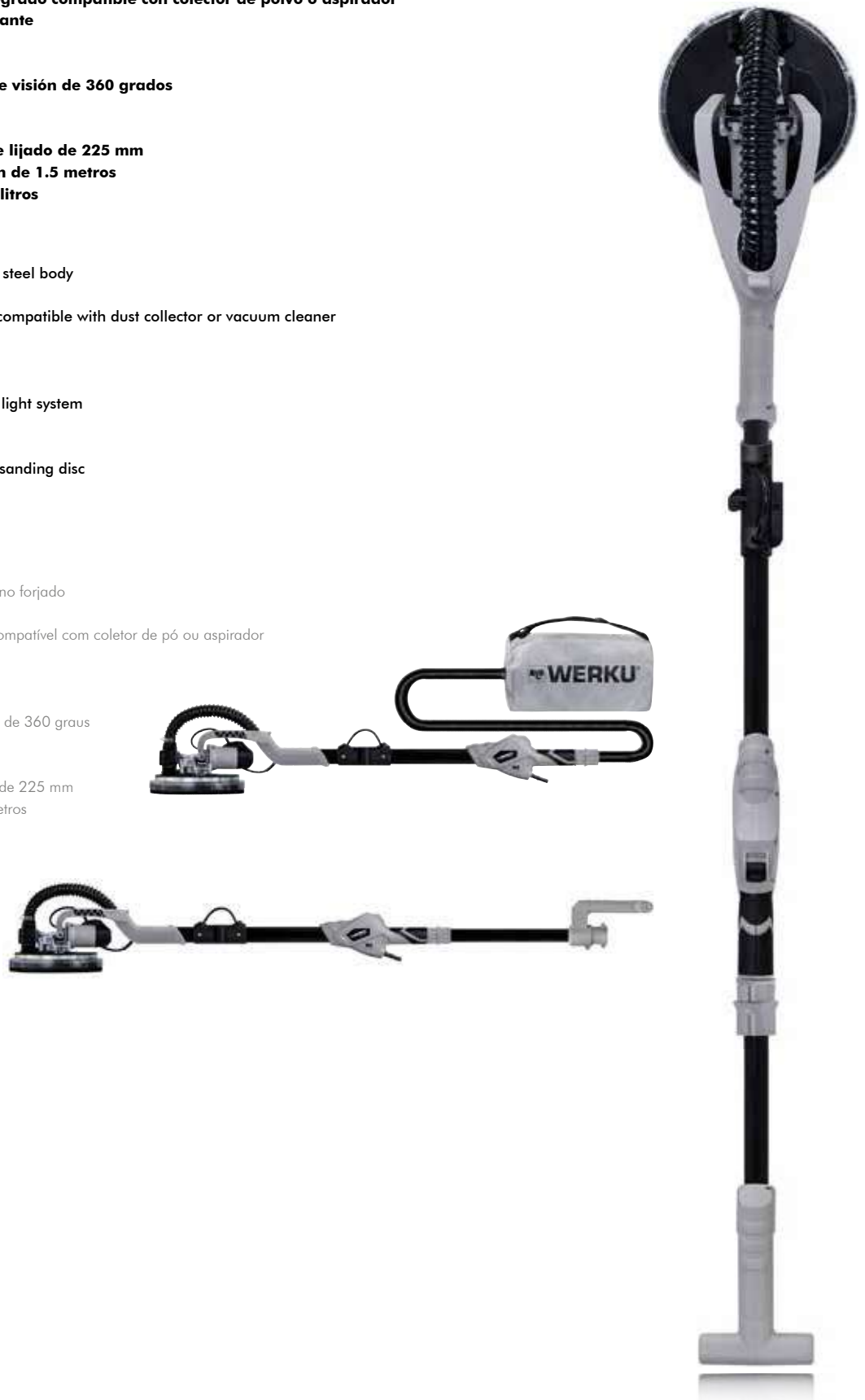

Inclui mangueira de sucção de 1.5 metros

Inclui coletor de pó de 20 litros

Inclui correia de uso

Inclui bolsa de transporte



	<b>WK403070</b> 2 / 001-138.000
	750 W
	1000-1850 RPM
	6
	225 MM
	1300-1800 MM
	0-90°
	CE
	8 424835 001216

# Lijadora Circular Paredes-Techos

## Circular Wall-Ceiling Sander

Lixadora Circular Paredes-Tetos

**Cuerpo de ABS composite y aluminio anodizado**

**Motor brushless sin escobillas**

**Interruptor con botón de funcionamiento continuo**

**Sistema de extracción compatible con aspirador**

**Mango ergonómico y antideslizante**

**Mango auxiliar de soporte**

**Selector de 7 velocidades**

**Sistema integrado de luz LED de visión de 360 grados**

**Fijación del disco con velcro**

**Display digital**

**Extensible y plegable**

**Incluye disco microperforado de lijado de 225 mm**

**Incluye manguera de aspiración de 4.5 metros**

**Incluye bolsa de transporte**

Composite ABS and anodized aluminum body

Brushless motor

Switch with continuous operation button

Extraction system compatible with vacuum cleaner

Ergonomic and non-slip handle

Support auxiliary handle

7 speed selector

Integrated 360 degrees vision LED light system

Disc fixing with velcro

Digital display

Extendable and foldable

Includes 225 mm microperforated sanding disc

Includes 4.5-meter suction hose

Includes transportation bag

Corpo de ABS composite e alumínio anodizado

Motor brushless sem escovas

Interruptor com botão de operação contínua

Sistema de extracção compatible com aspirador

Cabo ergonômico e antiderrapante

Cabo auxiliar de suporte

Selector de 7 velocidades

Sistema integrado de luz LED de visão de 360 graus

Fixação do disco com velcro

Display digital









Extensível e dobrável

Inclui disco microperforado de lixado de 225 mm

Inclui mangueira de sucção de 4.5 metros

Inclui bolsa de transporte



	<b>WK403260</b> 1 / 001-188.000
	400 W
	900-2100 RPM
	7
	225 MM
	1200-1800 MM
	0-90°
	CE
	8 424835 010294



# Lijadora Circular Paredes-Techos Inalámbrica

## Cordless Circular Wall-Ceiling Sander

Lixadora Circular Paredes-Tetos Sem Fios

**Cuerpo de ABS composite y aluminio anodizado**

**Motor brushless sin escobillas**

**Interruptor con botón de funcionamiento continuo**

**Sistema de auto-extracción integrado compatible con colector de polvo o aspirador**

**Mango ergonómico y antideslizante**

**Mango auxiliar de soporte**

**Selector de 7 velocidades**

**Fijación del disco con velcro**

**Extensible y plegable**

**Incluye disco microperforado de lijado de 225 mm**

**Incluye manguera de aspiración de 4.5 metros**

**Incluye colector de polvo de 20 litros**

**Incluye correa de uso**

**No incluye batería y cargador**

Composite ABS and anodized aluminum body

Brushless motor

Switch with continuous operation button

Integrated auto-extraction system compatible with dust collector or vacuum cleaner

Ergonomic and non-slip handle

Support auxiliary handle

7 speed selector

Disc fixing with velcro

Extendable and foldable

Includes 225 mm microperforated sanding disc

Includes 4.5-meter suction hose

Includes 20 liter dust collector

Includes use belt

Battery and charger not included

Corpo de ABS composite e alumínio anodizado

Motor brushless sem escovas

Interruptor com botão de operação contínua

Sistema de auto-extração integrado compatível com coletor de pó ou aspirador

Cabo ergonômico e antiderrapante

Cabo auxiliar de suporte

Selector de 7 velocidades

Fixação do disco com velcro

Extensível e dobrável

Inclui disco microperforado de lixado de 225 mm









Inclui mangueira de sucção de 4.5 metros

Inclui coletor de pó de 20 litros

Inclui correia de uso

Não inclui bateria e carregador



	<b>WK403430</b> 1 / 001-148.000
	20 V
	600-1200 RPM
	7
	225 MM
	1100-1650 MM
	0-90°
	CE
	8 424835 011154



# Lijadora Circular Paredes-Techos Hormigón

## Circular Concrete Wall-Ceiling Sander

Lixadora Circular Paredes-Tetos Concreto

**Cuerpo de ABS composite y aluminio anodizado**

**Interruptor de funcionamiento continuo**

**Sistema de extracción compatible con aspirador**

**Mango ergonómico y antideslizante**

**Mango auxiliar de soporte orientable**

**Selector de 6 velocidades**

**Extensible**

**Incluye disco diamantado de lijado de 125 mm**

**Incluye manguera de aspiración de 3.8 metros**

**Incluye bolsa de transporte**

Composite ABS and anodized aluminum body

Continuous operation switch

Extraction system compatible with vacuum cleaner

Ergonomic and non-slip handle

Adjustable support auxiliary handle

6 speed selector

Extendable

Includes 125 mm diamond-tipped sanding disc

Includes 3.8-meter suction hose

Includes transportation bag

Corpo de ABS composite e alumínio anodizado

Interruptor de operação contínua

Sistema de extração compatível com aspirador

Cabo ergonômico e antiderrapante

Cabo auxiliar de suporte orientável

Selector de 6 velocidades











Extensível

Inclui disco diamantado de lixado de 125 mm

Inclui mangueira de sucção de 3.8 metros

Inclui bolsa de transporte



	<b>WK400210</b> 2 / 001-174.000
	1010 W
	1700-3500 RPM
	6
	125 X 22 MM
	M-14
	1100-1700 MM
	0-90°
	CE
	8 424835 007294



**Idóneo para el lijado de superficies de hormigón y cemento. Disco de lijado diamantado y electrodepositado con bordes segmentados de autoafilado. Inducido e inductor con embobinado de cobre. Rodamientos herméticos. Placa electrónica sellada de ABS con circuitos impresos de aluminio. Engranajes de alta precisión. Equilibrio óptimo entre motor, eje y disco.**

*Ideal for sanding concrete and cement surfaces. Diamond and electroplated sanding disc with segmented self-sharpening edges. Armature and inductor with copper winding Hermetic bearings. Sealed ABS electronic board with aluminum printed circuits. High precision gears. Optimal balance between motor, shaft and disc.*

*Idéal para lixar superficies de concreto e cimento. Disco de lixa diamantado e galvanizado com bordas autoafiáveis segmentadas. Armadura e indutor com enrolamento de cobre. Rolamentos herméticos. Placa eletrônica ABS selada com circuitos impressos em alumínio. Engrenagens de alta precisão. Ótimo equilíbrio entre motor, eixo e disco.*

# Lijadora Circular Paredes

## Circular Wall Sander

Lixadora Circular Paredes

**Cuerpo de ABS composite**

**Interruptor con botón de funcionamiento continuo**

**Sistema de auto-extracción integrado compatible con colector de polvo o aspirador**

**Mango ergonómico y antideslizante**

**Mango con protector de puño**

**Mango auxiliar de soporte de 2 posiciones**

**Selector de 6 velocidades**

**Sistema integrado de luz LED de visión de 360 grados**

**Fijación del disco con velcro**

**Incluye disco microperforado de lijado de 225 mm**

**Incluye manguera de aspiración de 1.5 metros**

**Incluye colector de polvo de 20 litros**

**Incluye correa de uso**

Composite ABS body

Switch with continuous operation button

Integrated auto-extraction system compatible with dust collector or vacuum cleaner

Ergonomic and non-slip handle

Fist protector handle

2-position support auxiliary handle

6 speed selector

Integrated 360 degrees vision LED light system

Disc fixing with velcro

Includes 225 mm microperforated sanding disc

Includes 1.5-meter suction hose

Includes 20 liter dust collector

Includes use belt

Corpo de ABS composite

Interruptor com botão de operação contínua

Sistema de auto-extração integrado compatível com coletor de pó ou aspirador

Cabo ergonômico e antiderrapante

Cabo com protector de punho

Cabo auxiliar de suporte de 2 posições

Selector de 6 velocidades

Sistema integrado de luz LED de visão de 360 graus

Fixação do disco com velcro







Inclui disco microperforado de lixado de 225 mm

Inclui mangueira de sucção de 1.5 metros

Inclui coletor de pó de 20 litros

Inclui correia de uso



	<b>WK403250</b> 2 / 001-072.000
	1200 W
	1500-2600 RPM
	6
	225 MM
	CE
	8 424835 003531



# Lijadora Circular Paredes

## Circular Wall Sander

Lixadora Circular Paredes

**Cuerpo de ABS composite**

**Interruptor con botón de funcionamiento continuo**

**Sistema de auto-extracción integrado compatible con colector de polvo o aspirador**

**Mango ergonómico y antideslizante**

**Mango auxiliar de soporte**

**Selector de 6 velocidades**

**Sistema integrado de luz LED de visión de 360 grados**

**Fijación del disco con velcro**

**Incluye disco microperforado de lijado de 225 mm**

**Incluye manguera de aspiración de 1.5 metros**

**Incluye colector de polvo de 20 litros**

**Incluye correa de uso**

Composite ABS body

Switch with continuous operation button

Integrated auto-extraction system compatible with dust collector or vacuum cleaner

Ergonomic and non-slip handle

Support auxiliary handle

6 speed selector

Integrated 360 degrees vision LED light system

Disc fixing with velcro

Includes 225 mm microperforated sanding disc

Includes 1.5-meter suction hose

Includes 20 liter dust collector

Includes use belt

Corpo de ABS composite

Interruptor com botão de operação contínua

Sistema de auto-extração integrado compatível com coletor de pó ou aspirador

Cabo ergonômico e antiderrapante

Cabo auxiliar de suporte

Selector de 6 velocidades

Sistema integrado de luz LED de visão de 360 graus

Fixação do disco com velcro







Inclui disco microperforado de lixado de 225 mm

Inclui mangueira de sucção de 1.5 metros

Inclui coletor de pó de 20 litros

Inclui correia de uso



	<b>WK403300</b> 2 / 001-082.000
	1200 W
	1000-1950 RPM
	6
	225 MM
	CE
	8 424835 010720



# Lijadora Circular Paredes Inalámbrica

## Cordless Circular Wall Sander

Lixadora Circular Paredes Sem Fios

**Cuerpo de ABS composite**

**Motor brushless sin escobillas**

**Interruptor con botón de funcionamiento continuo**

**Sistema de auto-extracción integrado compatible con colector de polvo o aspirador**

**Mango ergonómico y antideslizante**

**Mango auxiliar de soporte**

**Selector de 6 velocidades**

**Fijación del disco con velcro**

**Display digital**

**Incluye disco microperforado de lijado de 225 mm**

**Incluye manguera de aspiración de 2 metros**

**Incluye colector de polvo de 20 litros**

**Incluye correa de uso**

**No incluye batería y cargador**

Composite ABS body

Brushless motor

Switch with continuous operation button

Integrated auto-extraction system compatible with dust collector or vacuum cleaner

Ergonomic and non-slip handle

Support auxiliary handle

6 speed selector

Disc fixing with velcro

Digital display

Includes 225 mm microperforated sanding disc

Includes 2-meter suction hose

Includes 20 liter dust collector

Includes use belt

Battery and charger not included

Corpo de ABS composite

Motor brushless sem escovas

Interruptor com botão de operação contínua

Sistema de auto-extração integrado compatível com coletor de pó ou aspirador

Cabo ergonômico e antiderrapante

Cabo auxiliar de suporte

Selector de 6 velocidades

Fixação do disco com velcro

Display digital

Inclui disco microperforado de lixado de 225 mm







Inclui mangueira de sucção de 2 metros

Inclui coletor de pó de 20 litros

Inclui correia de uso

Não inclui bateria e carregador



	<b>WK403440</b> 4 / 001-098.000
	20 V
	600-1200 RPM
	6
	225 MM
	CE
	8 424835 011161



# Lijadora-Pulidora Circular Paredes Mortero-Yeso

## Circular Mortar-Drywall Sander-Polisher









Lixadora-Polidora Circular Paredes Argamassa-Gesso

- Cuerpo de ABS composite y aluminio anodizado**
- Interruptor con botón de funcionamiento continuo**
- Mango ergonómico y antideslizante**
- Mango auxiliar de soporte**
- Selector de 6 velocidades**
- Fijación del disco con velcro**
- Incluye disco de esponja de 390 mm**
- Incluye disco de raspado de 380 mm**
- Incluye disco de talocha de 380 mm**
- Incluye disco de lijado de 370 mm**

- Composite ABS and anodized aluminum body
- Switch with continuous operation button
- Ergonomic and non-slip handle
- Support auxiliary handle
- 6 speed selector
- Disc fixing with velcro
- Includes 390 mm sponge disc
- Includes 380 mm scraper disc
- Includes 380 mm trowel disc
- Includes 370 mm sanding disc

- Corpo de ABS composite e alumínio anodizado
- Interruptor com botão de operação contínua
- Cabo ergonômico e antiderrapante
- Cabo auxiliar de suporte
- Selector de 6 velocidades
- Fixação do disco com velcro
- Inclui disco de esponja de 390 mm
- Inclui disco de raspador de 380 mm
- Inclui disco de talocha de 380 mm
- Inclui disco de lixado de 370 mm



	<b>WK401090</b> 1 / 001-126.000
	710 W
	60-110 RPM
	6
	390 MM
	M-6
	CE
	8 424835 008215

# Cepillo Paredes Hormigón

## Concrete Wall Planer

Plaina Paredes Concreto

**Cuerpo de ABS composite y aluminio anodizado**

**Sistema de extracción compatible con aspirador**

**Mango ergonómico y antideslizante**

**Mango con protector de puño**

**Mango auxiliar de soporte**

**Incluye disco diamantado de 12 cuchillas de cepillado de 50 mm**

**Incluye manguera de aspiración de 1.5 metros**

**Incluye maletín de transporte de HDPE**

Composite ABS and anodized aluminum body

Extraction system compatible with vacuum cleaner

Ergonomic and non-slip handle

Fist protector handle

Support auxiliary handle

Includes diamond-tipped disc with 12 planing blades of 50 mm

Includes 1.5-meter suction hose

Includes HDPE transportation case

Corpo de ABS composite e alumínio anodizado

Sistema de extracção compatible com aspirador

Cabo ergonômico e antiderrapante

Cabo com protector de punho









Cabo auxiliar de suporte

Inclui disco diamantado de 12 lâminas de aplainamento de 50 mm

Inclui mangueira de sucção de 1,5 metros

Inclui mala de transporte de HDPE



	<b>WK401100</b> 1 / 001-168.000
	1200 W
	9600 RPM
	50 MM
	0-3.5 MM
	52 MM
	CE
	8 424835 008222

# Lijadora Circular Paredes Hormigón

## Circular Concrete Wall Sander

Lixadora Circular Paredes Concreto

**Cuerpo de ABS composite y acero carbono forjado**

**Sistema de extracción compatible con aspirador**

**Mango ergonómico y antideslizante**

**Mango auxiliar de soporte**

**Selector de 7 velocidades**

**Incluye disco diamantado de lijado de 125 mm**

Composite ABS and forged carbon steel body

Extraction system compatible with vacuum cleaner

Ergonomic and non-slip handle

Support auxiliary handle

7 speed selector

Includes 125 mm diamond-tipped sanding disc

Corpo de ABS composite e aço carbono forjado

Sistema de extracção compatible com aspirador









Cabo ergonómico e antiderrapante

Cabo auxiliar de suporte

Selector de 7 velocidades

Inclui disco diamantado de lixado de 125 mm



	<b>WK400200</b> 2 / 001-128.000
	1500 W
	2500-4500 RPM
	7
	125 X 22 MM
	M-14
	CE
	8 424835 007287

# Sierra Circular Mármol-Piedra

## Marble-Stone Circular Saw

Serra Circular Mármore-Pedra

**Cuerpo de ABS composite y aluminio anodizado**

**Interruptor con botón de funcionamiento continuo**

**Mango ergonómico y antideslizante**

**Mango con protector de puño**

**Sistema de refrigeración con agua**

**Base graduable y guía de corte**

**Incluye disco diamantado de corte de 125 mm**

**Incluye grifo con manguera de suministro de agua de 1 metro**

Composite ABS and anodized aluminum body

Switch with continuous operation button

Ergonomic and non-slip handle

Fist protector handle

Water cooling system

Adjustable base and cutting guide

Includes 125 mm diamond-tipped cutting disc

Includes tap with 1-meter water supply hose

Corpo de ABS composite e alumínio anodizado

Interruptor com botão de operação contínua

Cabo ergonômico e antiderrapante

Cabo com protector de punho









Sistema de refrigeração com água

Base graduável e guia de corte

Inclui disco diamantado de corte de 125 mm

Inclui torneira com mangueira de abastecimento de água de 1 metro



	<b>WK400740</b> 4 / 001-048.000
	1250 W
	13800 RPM
	125 X 20 MM
	0 - 40 MM
	M-6
	0-45°
	CE
	8 424835 009526

# Rozadora Circular Paredes

## Circular Wall Chaser

### Roçadora Circular Paredes

**Cuerpo de ABS composite y aluminio anodizado**

**Sistema de auto-extracción integrado compatible con colector de polvo o aspirador**

**Mango ergonómico y antideslizante**

**Mango auxiliar de soporte**

**Sistema de refrigeración con agua**

**Base graduable y guía de corte mediante rodillos**

**Incluye disco diamantado de corte de triple hoja de 150 mm**

**Incluye colector de polvo de 5 litros**

**Incluye manguera de aspiración de 1 metro**

**Incluye maletín de transporte de HDPE**

Composite ABS and anodized aluminum body

Integrated auto-extraction system compatible with dust collector or vacuum cleaner

Ergonomic and non-slip handle

Support auxiliary handle

Water cooling system

Adjustable base and cutting guide by means of rollers

Includes 150 mm diamond-tipped triple blade cutting disc

Includes 1-meter suction hose

Includes 5 liter dust collector

Includes HDPE transportation case

Corpo de ABS composite e alumínio anodizado

Sistema de auto-extração integrado compatível com coletor de pó ou aspirador

Cabo ergonômico e antiderrapante

Cabo auxiliar de suporte

Sistema de refrigeração com água

Base ajustável e guia de corte por rolos









Inclui disco diamantado de corte de tripla lâmina de 150 mm

Inclui coletor de pó de 5 litros

Inclui mangueira de sucção de 1 metro

Inclui mala de transporte de HDPE



	<b>WK403230</b> 2 / 001-172.000
	2400 W
	8000 RPM
	150 X 22 MM
	28 MM
	8-43 MM
	M-8
	CE
	8 424835 009052

# Cortador Circular Hormigón

## Circular Concrete Cutter

### Cortador Circular Concreto

**Cuerpo de ABS composite y aluminio anodizado**

**Sistema de extracción compatible con aspirador**

**Mango ergonómico y antideslizante**

**Mango con protector de puño**

**Mango auxiliar de soporte**

**Indicador LED de sobrecarga**

**Sistema de refrigeración con agua**

**Base graduable y guía de corte mediante rodillos**

**Incluye disco diamantado de corte de 350 mm**

**Incluye grifo con manguera de suministro de agua de 5 metros**

**Incluye dispositivo de protección PRCD**

Composite ABS and anodized aluminum body

Extraction system compatible with vacuum cleaner

Ergonomic and non-slip handle

Fist protector handle

Support auxiliary handle

Overload indicator LED

Water cooling system

Adjustable base and cutting guide by means of rollers

Includes 350 mm diamond-tipped triple blade cutting disc

Includes tap with 5-meter water supply hose

Includes PRCD protection device

Corpo de ABS composite e alumínio anodizado

Sistema de extracção compatible com aspirador

Cabo ergonômico e antiderrapante

Cabo com protector de punho

Cabo auxiliar de suporte

Indicador LED de sobrecarga

Sistema de refrigeração com água









Base ajustável e guia de corte por rolos

Inclui disco diamantado de corte de tripla lâmina de 350 mm

Inclui torneira com mangueira de abastecimento de água de 5 metros

Inclui dispositivo de proteção PRCD



	<b>WK403490</b> 1 / 001-282.000
	2600 W
	4300 RPM
	350 X 25.4 MM
	0 - 125 MM
	M-10
	CE
	8 424835 011215





**Idóneo para el corte de superficies de hormigón y cemento. Disco de corte diamantado y electrodepositado con bordes segmentados de autoafilado. Inducido e inductor con embobinado de cobre. Rodamientos herméticos. Placa electrónica sellada de ABS con circuitos impresos de aluminio. Engranajes de alta precisión. Equilibrio óptimo entre motor, eje y disco.**

**Ideal for cutting concrete and cement surfaces. Diamond and electroplated cutting disc with segmented self-sharpening edges. Armature and inductor with copper winding Hermetic bearings. Sealed ABS electronic board with aluminum printed circuits. High precision gears. Optimal balance between motor, shaft and disc.**

**Ideal para cortar superficies de concreto e cemento. Disco de corte diamantado e galvanizado com bordas autoafiáveis segmentadas. Armadura e indutor com enrolamento de cobre. Rolamentos herméticos. Placa eletrônica ABS selada com circuitos impressos em alumínio. Engrenagens de alta precisão. Ótimo equilíbrio entre motor, eixo e disco.**





# Aspirador Seco-Húmedo

## Dry-Wet Vacuum Cleaner

### Aspirador Seco-Úmido

**Cuerpo de ABS composite**

**Depósito de acero inoxidable**

**Ruedas de polipropileno de 50 mm**

**Ruedas orientables en 360 grados**

**Interruptor de funcionamiento continuo**

**Doble filtrado mediante bolsa de polvo y filtro HEPA**

**Función de sincronización de arranque automático con herramientas eléctricas**

**Función de drenaje del depósito**

**Función de soplado de aire**

**Cadena anti-electrostática**

**Incluye mango de aspiración extensible de dos piezas 480-920 mm**

**Incluye 2 cabezales de aspiración y limpieza**

**Incluye 2 conectores de manguera para herramientas eléctricas**

**Incluye manguera de aspiración de 1.5 metros**

**Incluye bolsa reutilizable colectora de polvo de 20-30 litros**

**Incluye filtro HEPA para sólidos**

**Incluye filtro esponja para líquidos**

Composite ABS body

Stainless-steel tank

Polypropylene wheels of 50 mm

Adjustable wheels in 360 degrees

Continuous operation switch

Double filtering by dust bag and HEPA filter

Automatic start synchronization function with power tools

Tank drain function

Air blow function

Anti-electrostatic chain

Includes two-piece 480-920 mm extendable suction handle

Includes 2 suction and cleaning heads

Includes 2 hose connectors for power tools

Includes 1.5-meter suction hose

Includes 20-30 liter reusable dust collection bag

Includes HEPA filter for solids

Includes sponge filter for liquids

Corpo de ABS composite

Tanque de aço inoxidável

Rodas de polipropileno de 50 mm

Rodas ajustáveis em 360 graus

Interruptor de operação contínua

Duplo filtragem através de saco de pó e filtro HEPA

Função de sincronização de início automático com ferramentas elétricas

Função de drenagem do tanque

Função soprado de ar

Cadeia anti-eletróstática

Inclui cabo de sucção extensível de duas peças 480-920 mm

Inclui 2 cabeças de sucção e limpeza

Inclui 2 conectores de mangueira para ferramentas









Inclui mangueira de sucção de 1,5 metros

Inclui bolsa reutilizável coletora de pó de 20-30 litros

Inclui filtro HEPA para sólidos

Inclui filtro esponja para líquidos



	<b>WK402010</b> 1 / 001-074.000	<b>WK402020</b> 1 / 001-082.000
	1200 W	1200 W
	20 L	30 L
	3500 LPM	3500 LPM
	180 MBAR	180 MBAR
	≤ 2000 W	≤ 2000 W
	CE	CE
	8 424835 007218	8 424835 007225



# Aspirador Seco-Húmedo

## Dry-Wet Vacuum Cleaner

### Aspirador Seco-Úmido

**Cuerpo de ABS composite**

**Depósito de acero inoxidable**

**Ruedas de PVC de 63 y 150 mm**

**Ruedas orientables en 360 grados**

**Asa de transporte acolchada de caucho**

**Interruptor de funcionamiento continuo**

**Doble filtrado mediante bolsa de polvo y filtro HEPA**

**Función de sincronización de arranque automático con herramientas eléctricas**

**Función de drenaje del depósito**

**Función de soplado de aire**

**Cadena anti-electrostática**

**Incluye mango de aspiración extensible de dos piezas 480-920 mm**

**Incluye 2 cabezales de aspiración y limpieza**

**Incluye 2 conectores de manguera para herramientas eléctricas**

**Incluye manguera de aspiración de 1.5 metros**

**Incluye bolsa reutilizable colectora de polvo de 50-60 litros**

**Incluye filtro HEPA para sólidos**

**Incluye filtro esponja para líquidos**

Composite ABS body

Stainless-steel tank

PVC wheels of 63 and 150 mm

Adjustable wheels in 360 degrees

Rubber padded carry handle

Continuous operation switch

Double filtering by dust bag and HEPA filter

Automatic start synchronization function with power tools

Tank drain function

Air blow function

Anti-electrostatic chain

Includes two-piece 480-920 mm extendable suction handle

Includes 2 suction and cleaning heads

Includes 2 hose connectors for power tools

Includes 1.5-meter suction hose

Includes 50-60 liter reusable dust collection bag

Includes HEPA filter for solids

Includes sponge filter for liquids

Corpo de ABS composite

Tanque de aço inoxidável

Rodas de PVC de 63 e 150 mm

Rodas ajustáveis em 360 graus

Alça de transporte acolchoada de borracha

Interruptor de operação contínua

Duplo filtragem através de saco de pó e filtro HEPA

Função de sincronização de início automático com ferramentas elétricas

Função de drenagem do tanque

Função soprado de ar

Cadeia anti-eletróstática

Inclui cabo de sucção extensível de duas peças 480-920 mm

Inclui 2 cabeças de sucção e limpeza

Inclui 2 conectores de mangueira para ferramentas









Inclui mangueira de sucção de 1.5 metros

Inclui bolsa reutilizável colectora de pó de 50-60 litros

Inclui filtro HEPA para sólidos

Inclui filtro esponja para líquidos



	<b>WK402030</b> 1 / 001-118.000	<b>WK403310</b> 1 / 001-128.000
	1400 W	1400 W
	50 L	60 L
	3500 LPM	3500 LPM
	180 MBAR	180 MBAR
	≤ 2000 W	≤ 2000 W
	CE	CE
	8 424835 007232	8 424835 010607



# Aspirador Seco-Húmedo

## Dry-Wet Vacuum Cleaner

### Aspirador Seco-Úmido

**Cuerpo de ABS composite**

**Depósito de polipropileno y PVC**

**Ruedas de caucho de 50 mm y de polipropileno y PVC de 150 mm**

**Ruedas delanteras orientables en 360 grados**

**Asa de transporte acolchada de caucho**

**Interruptor de funcionamiento continuo**

**Triple filtrado mediante bolsa de polvo, depósito de agua y filtro HEPA**

**Regulador de potencia**

**Función de sincronización de arranque automático con herramientas eléctricas**

**Función de soplado de aire**

**Función de limpieza rápida del filtro**

**Incluye 5 cabezales de aspiración y limpieza**

**Incluye 2 conectores de manguera para herramientas eléctricas**

**Incluye manguera de aspiración de 2 metros**

**Incluye bolsa reutilizable colectora de polvo de 20-30 litros**

**Incluye filtro HEPA para sólidos**

**Incluye filtro esponja para líquidos**

Composite ABS body

Polypropylene and PVC tank

Rubber wheels of 50 mm and polypropylene and PVC wheels of 150 mm

Adjustable front wheels in 360 degrees

Rubber padded carrying handle

Continuous operation switch

Triple filtering by dust bag, water tank and HEPA filter

Power regulator

Automatic start synchronization function with power tools

Air blow function

Filter quick clean function

Includes 5 suction and cleaning heads

Includes 2 hose connectors for power tools

Includes 2-meter suction hose

Includes 20-30 liter reusable dust collection bag

Includes HEPA filter for solids

Includes sponge filter for liquids

Corpo de ABS composite

Tanque de polipropileno e PVC

Rodas de borracha de 50 mm e de polipropileno e PVC de 150 mm

Rodas dianteiras ajustáveis em 360 graus

Alça de transporte acolchoada de borracha

Interruptor de operação contínua

Tripla filtragem através de saco de pó, tanque de água e filtro HEPA

Regulador de potência

Função de sincronização de início automático com ferramentas elétricas

Função soprado de ar

Função de limpeza rápida do filtro

Inclui 5 cabeças de sucção e limpeza

Inclui 2 conectores de mangueira para ferramentas









Inclui mangueira de sucção de 2 metros

Inclui bolsa reutilizável coletora de pó de 20-30 litros

Inclui filtro HEPA para sólidos

Inclui filtro esponja para líquidos



	<b>WK401450</b> 1 / 001-198.000
	1600 W
	30 L
	3700 LPM
	180 MBAR
	≤ 2000 W
	CE
	8 424835 010065

## Bolsa Polvo Aspirador Vacuum Cleaner Dustbag Saco Pó Aspirador



**WK402010**  
**WK402020**  
**WK402030**  
**WK403310**  
**WK401450**

**Cuerpo de polipropileno SMS**  
**Reutilizable**  
**Lavable**

SMS polypropylene body  
Reusable  
Washable

Corpo de polipropileno SMS  
Reutilizável  
Lavável



	<b>WK300530</b> 5 / 001-006.600	<b>WK300540</b> 5 / 001-008.800
	20-30 L	50-60 L
	450 MM	580 MM
	280 MM	330 MM
	36-61 MM	36-61 MM
PCS	2	2
	CE	CE
	8 424835 010614	8 424835 010621



## Mezclador Pintura-Mortero

### Paint-Mortar Mixer

Misturador Pintura-Argamassa

**Cuerpo de ABS composite y aluminio anodizado**

**Mango ergonómico y antideslizante**

**Mango auxiliar de soporte de 3 posiciones**

**Mango auxiliar de soporte ajustable en 360 grados**

**Regulador de velocidad**

**Función de rotación reversible**

**Incluye varilla mezcladora de 120 mm**

Composite ABS and anodized aluminum body

Ergonomic and non-slip handle

3-position support auxiliary handle

360 degree adjustable support auxiliary handle

Speed regulator

Reversible rotation function

Includes 120 mm mixer stirrer

Corpo de ABS composite e alumínio anodizado

Cabo ergonômico e antiderrapante

Cabo auxiliar de suporte de 3 posições











Cabo auxiliar de suporte ajustável em 360 graus

Regulador de velocidade

Função de rotação reversível

Inclui varilha misturadora de 120 mm



	<b>WK403140</b> 4 / 001-058.000
	1050 W
	0-580 RPM
	45 NM
	M-14
	120 MM
	600 MM
	50 KG
	CE
	8 424835 505059

## Mezclador Pintura-Mortero

### Paint-Mortar Mixer

Misturador Pintura-Argamassa

**Cuerpo de ABS composite y aluminio anodizado**

**Mango ergonómico y antideslizante**

**Selector de 6 velocidades**

**Selector de 2 rangos de velocidades**

**Incluye varilla mezcladora de 140 mm**

Composite ABS and anodized aluminum body

Ergonomic and non-slip handle

6 speed selector

2-speed range selector

Includes 140 mm mixer stirrer

Corpo de ABS composite e alumínio anodizado











Cabo ergonômico e antiderrapante

Selector de 6 velocidades

Selector de 2 níveis de velocidades

Inclui varilha misturadora de 140 mm



	<b>WK400130</b> 2 / 001-078.000	<b>WK401710</b> 2 / 001-088.000
	1600 W	1800 W
	180-400/300-700 RPM	180-400/300-700 RPM
	12	12
	60 NM	70 NM
	M-14	M-14
	140 MM	140 MM
	600 MM	600 MM
	75 KG	100 KG
	CE	CE
	8 424835 001339	8 424835 010737



# Mezclador Pintura-Mortero Inalámbrico

## Cordless Paint-Mortar Mixer

Misturador Pintura-Argamassa Sem Fios

**Cuerpo de ABS composite y aluminio anodizado**

**Motor brushless sin escobillas**

**Mango ergonómico y antideslizante**

**Selector de 5 velocidades**

**Selector de 2 rangos de velocidades**

**Incluye varilla mezcladora de 120 mm**

**No incluye batería y cargador**

Composite ABS and anodized aluminum body

Brushless motor

Ergonomic and non-slip handle

5 speed selector

2-speed range selector

Includes 120 mm mixer stirrer

Battery and charger not included

Corpo de ABS composite e alumínio anodizado

Motor brushless sem escovas

Cabo ergonômico e antiderrapante











Selector de 5 velocidades

Selector de 2 níveis de velocidades

Inclui varilha misturadora de 120 mm

Não inclui bateria e carregador



	<b>WK403280</b> 2 / 001-098.000
	20 V
	250-400/350-650 RPM
	10
	60 NM
	M-14
	120 MM
	600 MM
	75 KG
	CE
	8 424835 010744



## Mezclador Doble Pintura-Mortero

### Paint-Mortar Double Mixer

Misturador Duplo Pintura-Argamassa

**Cuerpo de ABS composite y aluminio anodizado**

**Mango ergonómico y antideslizante**

**Selector de 6 velocidades**

**Selector de 2 rangos de velocidades**

**Incluye 2 varillas mezcladoras de 120 mm**

Composite ABS and anodized aluminum body

Ergonomic and non-slip handle

6 speed selector

2-speed range selector

Includes 2 mixer stirrers of 120 mm

Corpo de ABS composite e alumínio anodizado

Cabo ergonômico e antiderrapante

Selector de 6 velocidades

Selector de 2 níveis de velocidades

Inclui 2 varilhas misturadoras de 120 mm



	<b>WK403240</b> 2 / 001-108.000
	1600 W
	200-480/250-680 RPM
	12
	70 NM
	HEX-13
	120 MM
	550 MM
	100 KG
	CE
	8 424835 007980



# Varilla Mezclador

## Mixer Stirrer

### Varinha Misturador

**Cuerpo de acero galvanizado**

**Juntas reforzadas con soldadura TIG**

**Conexión hexagonal para taladros**

**Compatible con mezclas de viscosidad baja**

**Dirección de fluido hacia abajo**

Galvanized steel body

Reinforced TIG welding joints

Hexagonal connection for drills

Compatible with low viscosity mixtures

Downwards fluid direction

Corpo de aço galvanizado







Juntas reforçadas com soldadura TIG

Conexão hexagonal para berbequims

Compatível com misturas de viscosidade baixa

Direção do fluido para baixo



	<b>WK602210</b> 12 / 006-002.200	<b>WK602220</b> 12 / 006-002.400	<b>WK602230</b> 12 / 006-004.200	<b>WK602240</b> 12 / 006-004.400
	HEX-8	HEX-8	HEX-9	HEX-9
	60 MM	80 MM	100 MM	120 MM
	400 MM	400 MM	600 MM	600 MM
	5-10 KG	5-15 KG	10-25 KG	15-30 KG
	8 424835 001421	8 424835 001155	8 424835 002497	8 424835 001162



## Varilla Mezclador

### Mixer Stirrer

#### Varinha Misturador

**Cuerpo de acero galvanizado**

**Juntas reforzadas con soldadura TIG**

**Conexión hexagonal para taladros**

**Compatible con mezclas de viscosidad media**

**Dirección de fluido hacia arriba**

Galvanized steel body

Reinforced TIG welding joints

Hexagonal connection for drills

Compatible with medium viscosity mixtures

Upwards fluid direction

Corpo de aço galvanizado

Juntas reforçadas com soldadura TIG

Conexão hexagonal para berbequims

Compatível com misturas de viscosidade média

Direção do fluido para cima



	<b>WK602100</b> 6 / 001-004.600	<b>WK602110</b> 6 / 001-005.200
	HEX-8	HEX-8
	100 MM	120 MM
	600 MM	600 MM
	10-25 KG	15-30 KG
	8 424835 510022	8 424835 002855

## Varilla Mezclador

### Mixer Stirrer

#### Varinha Misturador

**Cuerpo de acero galvanizado**

**Juntas reforzadas con soldadura TIG**

**Conexión hexagonal para taladros**

**Compatible con mezclas de viscosidad alta**

**Dirección de fluido hacia arriba**

Galvanized steel body

Reinforced TIG welding joints

Hexagonal connection for drills

Compatible with high viscosity mixtures

Upwards fluid direction

Corpo de aço galvanizado

Juntas reforçadas com soldadura TIG

Conexão hexagonal para berbequims

Compatível com misturas de viscosidade alta

Direção do fluido para cima



	<b>WK602080</b> 6 / 001-006.000	<b>WK602090</b> 6 / 001-006.600
	HEX-9	HEX-9
	100 MM	120 MM
	600 MM	600 MM
	10-25 KG	15-30 KG
	8 424835 006631	8 424835 006648

## Varilla Mezclador

### Mixer Stirrer

#### Varinha Misturador

**Cuerpo de acero galvanizado**

**Juntas reforzadas con soldadura TIG**

**Conexión métrica para mezcladores**

**Compatible con mezclas de viscosidad media**

**Dirección de fluido lateral**

Galvanized steel body

Reinforced TIG welding joints

Metric connection for mixers

Compatible with medium viscosity mixtures

Lateral fluid direction

Corpo de aço galvanizado

Juntas reforçadas com soldadura TIG

Conexão métrica para misturadores

Compatível com misturas de viscosidade média

Direção do fluido lateral



	<b>WK602550</b> 6 / 001-007.400	<b>WK602560</b> 6 / 001-008.000
	M-14	M-14
	120 MM	140 MM
	600 MM	600 MM
	15-30 KG	15-60 KG
	8 424835 010706	8 424835 010713

## Varilla Mezclador

### Mixer Stirrer

#### Varinha Misturador

**Cuerpo de acero galvanizado**

**Juntas reforzadas con soldadura TIG**

**Conexión métrica para mezcladores**

**Compatible con mezclas de viscosidad alta**

**Dirección de fluido lateral**

Galvanized steel body

Reinforced TIG welding joints

Metric connection for mixers

Compatible with high viscosity mixtures

Lateral fluid direction

Corpo de aço galvanizado

Juntas reforçadas com soldadura TIG

Conexão métrica para misturadores

Compatível com misturas de viscosidade alta

Direção do fluido lateral



	<b>WK602570</b> 12 / 001-006.000	<b>WK602580</b> 12 / 001-006.600
	M-14	M-14
	120 MM	140 MM
	600 MM	600 MM
	15-30 KG	15-60 KG
	8 424835 010775	8 424835 010782



## Varilla Mezclador

### Mixer Stirrer

Varinha Misturador

**Cuerpo de acero galvanizado**

**Juntas reforzadas con soldadura TIG**

**Conexión métrica para mezcladores**

**Compatible con mezclas de viscosidad media**

**Dirección de fluido hacia arriba**

Galvanized steel body

Reinforced TIG welding joints

Metric connection for mixers

Compatible with medium viscosity mixtures

Upwards fluid direction

Corpo de aço galvanizado







Juntas reforçadas com soldadura TIG

Conexão métrica para misturadores

Compatível com misturas de viscosidade média

Direção do fluido para cima



	<b>WK602010</b> 6 / 001-007.600	<b>WK602020</b> 6 / 001-008.200
	M-14	M-14
	120 MM	140 MM
	600 MM	600 MM
	15-30 KG	15-60 KG
	8 424835 001018	8 424835 003869

## Varilla Mezclador

### Mixer Stirrer

Varinha Misturador

**Cuerpo de acero galvanizado**

**Juntas reforzadas con soldadura TIG**

**Conexión métrica para mezcladores**

**Compatible con mezclas de viscosidad alta**

**Dirección de fluido hacia arriba**

Galvanized steel body

Reinforced TIG welding joints

Metric connection for mixers

Compatible with high viscosity mixtures

Upwards fluid direction

Corpo de aço galvanizado







Juntas reforçadas com soldadura TIG

Conexão métrica para misturadores

Compatível com misturas de viscosidade alta

Direção do fluido para cima



	<b>WK602030</b> 6 / 001-009.000	<b>WK602040</b> 6 / 001-009.600
	M-14	M-14
	120 MM	140 MM
	600 MM	600 MM
	15-30 KG	15-60 KG
	8 424835 006655	8 424835 006662

## Pistola Pintar Succión HVLP-I

### HVLP-I Suction Paint Spray Gun











Pistola Pintar Sucção HVLP-I

**Cuerpo de ABS composite**  
**Mango ergonómico y antideslizante**  
**Cabezal de liberación rápida**  
**Cabezal intercambiable**  
**Regulador de abanico**  
**Regulador de fluido**  
**Incluye viscosímetro**

Composite ABS body  
 Ergonomic and non-slip handle  
 Quick release head  
 Interchangeable head  
 Pattern regulator  
 Fluid spray regulator  
 Includes viscometer

Corpo de ABS composite  
 Cabo ergonômico e antiderrapante  
 Cabeçal de liberação rápida  
 Cabeçal intercambiável  
 Regulador de leque  
 Regulador de fluido  
 Inclui viscosímetro



	<b>WK401200</b> 6 / 001-038.000
	500 W
	0.4 BAR
	1.4 BAR
	1.8 / 2.6 MM
	80 DIN SEC
	800 ML
	800 ML MIN
	CE
	8 424835 007669



## Pistola Pintar Succión Turbina HVLP-I

### HVLP-I Turbine Suction Paint Spray Gun











Pistola Pintar Sucção Turbina HVLP-I

**Cuerpo de ABS composite**  
**Mango ergonómico y antideslizante**  
**Cabezal de liberación rápida**  
**Cabezal intercambiable**  
**Regulador de abanico**  
**Regulador de fluido**  
**Incluye viscosímetro**  
**Incluye manguera de 1.8 metros**  
**Incluye correa de uso**

Composite ABS body  
 Ergonomic and non-slip handle  
 Quick release head  
 Interchangeable head  
 Pattern regulator  
 Fluid spray regulator  
 Includes viscometer  
 Includes 1.8-meter hose  
 Includes use belt

Corpo de ABS composite  
 Cabo ergonômico e antiderrapante  
 Cabeçal de liberação rápida  
 Cabeçal intercambiável  
 Regulador de leque  
 Regulador de fluido  
 Inclui viscosímetro  
 Inclui mangueira de 1.8 metros  
 Inclui correia de uso



	<b>WK401210</b> 2 / 001-054.000
	650 W
	0.4 BAR
	1.4 BAR
	1.8 / 2.6 MM
	80 DIN SEC
	800 ML
	800 ML MIN
	CE
	8 424835 007676



# Pistola Pintar Succión Turbina-Trolley HVLP-I

## HVLP-I Turbine-Trolley Suction Paint Spray Gun

### Pistola Pintar Sucção Turbina-Trolley HVLP-I

Cuerpo de ABS composite

Ruedas de polipropileno de 130 mm

Mango ergonómico y antideslizante

Asa de transporte extensible

Cabezal de liberación rápida

Cabezal intercambiable

Regulador de abanico

Regulador de fluido

Incluye viscosímetro

Incluye manguera de 3 metros

Composite ABS body

Polypropylene wheels of 130 mm

Ergonomic and non-slip handle

Extendable carry handle

Quick release head

Interchangeable head

Pattern regulator

Fluid spray regulator

Includes viscometer

Includes 3-meter hose

Corpo de ABS composite

Rodas de polipropileno de 130 mm

Cabo ergonômico e antiderrapante

Alça de transporte extensível

Cabeçal de liberação rápida

Cabeçal intercambiável

Regulador de leque

Regulador de fluido

Inclui viscosímetro

Inclui mangueira de 3 metros



**HVLP-I (alto volumen a baja presión) reduce el consumo del producto a pulverizar un 30%, acorta el tiempo de trabajo un 20%, disminuye el consumo de aire un 15% y genera una buena calidad de pulverización y acabado.**

HVLP-I (high volume at low pressure) reduces the consumption of the product to be sprayed by 30%, shortens the working time by 20%, reduces air consumption by 15% and generates a good quality of spray and finish.

HVLP-I (alto volumen a baixa pressão) reduz o consumo do produto a ser pulverizado em 30%, reduz o tempo de trabalho em 20%, reduz o consumo de ar em 15% e gera uma boa qualidade de pulverização e acabamento.

	<b>WK401180</b> 2 / 001-064.000
	750 W
	0.4 BAR
	1.4 BAR
	1.8 / 2.6 MM
	80 DIN SEC
	800 ML
	800 ML MIN
	CE
	8 424835 007652



## Pistola Aire Caliente

### Hot Air Gun

Pistola Ar Quente

- Cuerpo de ABS composite**
- Interruptor de funcionamiento continuo**
- Mango ergonómico y antideslizante**
- Mango con protector de puño**
- Selector de 2 velocidades**
- Incluye 6 accesorios de rascado**
- Incluye maletín de transporte de HDPE**

Composite ABS body  
Continuous operation switch  
Ergonomic and non-slip handle  
Fist protector handle  
2 speed selector  
Includes 6 scraper accessories  
Includes HDPE transportation case

Corpo de ABS composite  
Interruptor de operação contínua  
Cabo ergonômico e antiderrapante  
Cabo com protector de punho  
Selector de 2 velocidades  
Inclui 6 acessórios de raspagem  
Inclui mala de transporte de HDPE



## Pistola Aire Caliente

### Hot Air Gun







Pistola Ar Quente

- Cuerpo de ABS composite**
- Interruptor de funcionamiento continuo**
- Mango ergonómico y antideslizante**
- Mango con protector de puño**
- Regulador de la graduación de la temperatura**
- Selector de 3 velocidades**
- Incluye 6 accesorios de rascado**
- Incluye maletín de transporte de HDPE**







Composite ABS body  
Continuous operation switch  
Ergonomic and non-slip handle  
Fist protector handle  
Temperature graduation regulator  
3 speed selector  
Includes 6 scraper accessories  
Includes HDPE transportation case

Corpo de ABS composite  
Interruptor de operação contínua  
Cabo ergonômico e antiderrapante  
Cabo com protector de punho  
Regulador da graduação da temperatura  
Selector de 3 velocidades  
Inclui 6 acessórios de raspagem  
Inclui mala de transporte de HDPE



	<b>WK402060</b> 10 / 001-020.000
	2000 W
	300-500 LPM
	2
	350-600° C
	CE
	8 424835 007461



	<b>WK402070</b> 10 / 001-028.000
	2000 W
	300-500 LPM
	3
	50-600° C
	CE
	8 424835 007645

# Pistola Aire Caliente Digital

## Digital Hot Air Gun

Pistola Ar Quente Digital

**Cuerpo de ABS composite**

**Interruptor de funcionamiento continuo**

**Mango ergonómico y antideslizante**

**Mango con protector de puño**

**Regulador de la graduación de la temperatura**

**Selector de 3 velocidades**

**Display digital**

**Incluye 6 accesorios de rascado**

**Incluye maletín de transporte de HDPE**

Composite ABS body

Continuous operation switch

Ergonomic and non-slip handle

Fist protector handle

Temperature graduation regulator

3 speed selector

Digital display

Includes 6 scraper accessories

Includes HDPE transportation case

Corpo de ABS composite

Interruptor de operação contínua

Cabo ergonômico e antiderrapante

Cabo com protector de punho

Regulador da graduação da temperatura







Selector de 3 velocidades

Display digital

Inclui 6 acessórios de raspagem

Inclui mala de transporte de HDPE



	<b>WK402080</b> 10 / 001-036.000
	2000 W
	300-500 LPM
	3
	50-600° C
	CE
	8 424835 007454





## Lijadora Rectangular Rotorbital

### Rotorbital Rectangular Sander

Lixadora Rectangular Rotorbital

**Cuerpo de ABS composite**

**Motor brushless sin escobillas**

**Sistema de extracción compatible con aspirador**

**Mango con protector de puño**

**Selector de 6 velocidades**

**Función de giro rotorbital**

**Fijación de la hoja con velcro**

**Display digital**

**Incluye hoja microperforada de lijado de 80 x 135 mm**

**Incluye manguera de aspiración de 1.1 metros**

Composite ABS body

Brushless motor

Extraction system compatible with vacuum cleaner

Fist protector handle

6 speed selector

Rotorbital spin function

Velcro sheet fixing

Digital display

Includes 80 x 135 mm microperforated sanding sheet

Includes 1.1-meter suction hose

Corpo de ABS composite

Motor brushless sem escovas

Sistema de extracção compatible com aspirador

Cabo com protector de punho

Selector de 6 velocidades

Função de rotação rotorbital

Fixação da folha com velcro

Display digital

Inclui folha microperforada de lixado de 80 x 135 mm

Inclui manguera de sucção de 1.1 metros



## Lijadora Rectangular Rotorbital

### Rotorbital Rectangular Sander

Lixadora Rectangular Rotorbital

**Cuerpo de ABS composite**

**Motor brushless sin escobillas**

**Sistema de extracción compatible con aspirador**

**Mango con protector de puño**

**Selector de 6 velocidades**

**Función de giro rotorbital**

**Fijación de la hoja con velcro**

**Display digital**

**Incluye hoja microperforada de lijado de 70 x 195 mm**

**Incluye manguera de aspiración de 1.1 metros**

Composite ABS body

Brushless motor

Extraction system compatible with vacuum cleaner

Fist protector handle

6 speed selector

Rotorbital spin function

Velcro sheet fixing

Digital display

Includes 70 x 195 mm microperforated sanding sheet

Includes 1.1-meter suction hose

Corpo de ABS composite

Motor brushless sem escovas

Sistema de extracção compatible com aspirador

Cabo com protector de punho

Selector de 6 velocidades

Função de rotação rotorbital

Fixação da folha com velcro

Display digital

Inclui folha microperforada de lixado de 70 x 195 mm

Inclui manguera de sucção de 1.1 metros



	<b>WK401760</b> 4 / 001-136.000
	350 W
	4000-10000 RPM
	6
	80 X 135 MM
	3 MM
	CE
	8 424835 010881



	<b>WK401770</b> 4 / 001-136.000
	350 W
	4000-10000 RPM
	6
	70 X 195 MM
	2.5 MM
	CE
	8 424835 010898



# Lijadora Triangular Rotorbital

## Rotorbital Triangular Sander

### Lixadora Triangular Rotorbital

**Cuerpo de ABS composite**

**Motor brushless sin escobillas**

**Sistema de extracción compatible con aspirador**

**Mango con protector de puño**

**Selector de 6 velocidades**

**Función de giro rotorbital**

**Fijación de la hoja con velcro**

**Display digital**

**Incluye hoja microperforada de lijado de 100 x 150 mm**

**Incluye manguera de aspiración de 1.1 metros**

Composite ABS body

Brushless motor

Extraction system compatible with vacuum cleaner

Fist protector handle

6 speed selector

Rotorbital spin function

Velcro sheet fixing

Digital display

Includes 100 x 150 mm microperforated sanding sheet

Includes 1.1-meter suction hose

Corpo de ABS composite

Motor brushless sem escovas

Sistema de extracção compatible com aspirador

Cabo com protector de punho

Selector de 6 velocidades

Função de rotação rotorbital

Fixação da folha com velcro

Display digital

Inclui folha microperforada de lixado de 100 x 150 mm

Inclui manguera de sucção de 1.1 metros



	<b>WK401780</b> 4 / 001-136.000
	350 W
	4000-10000 RPM
	6
	100 X 150 X 150 MM
	3 MM
	CE
	8 424835 010904



# Lijadora Circular Rotorbital

## Rotorbital Circular Sander

Lixadora Circular Rotorbital

**Cuerpo de ABS composite**

**Interruptor de funcionamiento continuo**

**Sistema de auto-extracción integrado compatible con colector de polvo o aspirador**

**Mango ergonómico y antideslizante**

**Mango auxiliar de soporte orientable**

**Selector de 6 velocidades**

**Función de giro rotorbital**

**Fijación del disco con velcro**

**Incluye colector de polvo de 500 ml**

Composite ABS body

Continuous operation switch

Integrated auto-extraction system compatible with dust collector or vacuum cleaner

Ergonomic and non-slip handle

Adjustable support auxiliary handle

6 speed selector

Rotorbital spin function

Velcro disc fixing

Includes 500 ml dust collector

Corpo de ABS composite

Interruptor de operação contínua

Sistema de auto-extração integrado compatível com coletor de pó ou aspirador

Cabo ergonômico e antiderrapante

Cabo auxiliar de suporte orientável









Selector de 6 velocidades

Função de rotação rotorbital

Fixação do disco com velcro

Inclui coletor de pó de 500 ml



	<b>WK400100</b> 4 / 001-088.000
	710 W
	3000-6300 RPM
	6
	150 MM
	4 MM
	CE
	8 424835 006549

# Lijadora Circular Rotorbital

## Rotorbital Circular Sander

### Lixadora Circular Rotorbital

**Cuerpo de ABS composite**

**Motor brushless sin escobillas**

**Sistema de extracción compatible con aspirador**

**Mango con protector de puño**

**Selector de 6 velocidades**

**Función de giro rotorbital**

**Fijación del disco con velcro**

**Display digital**

**Incluye disco microperforado de lijado de 150 mm**

**Incluye manguera de aspiración de 1.1 metros**

Composite ABS body

Brushless motor

Extraction system compatible with vacuum cleaner

Fist protector handle

6 speed selector

Rotorbital spin function

Velcro disc fixing

Digital display

Includes 150 mm microperforated sanding disc

Includes 1.1-meter suction hose

Corpo de ABS composite

Motor brushless sem escovas

Sistema de extracção compatible com aspirador

Cabo com protector de punho

Selector de 6 velocidades

Função de rotação rotorbital

Fixação do disco com velcro

Display digital

Inclui disco microperforado de lixado de 150 mm

Inclui mangueira de sucção de 1.1 metros



	<b>WK401740</b> 4 / 001-136.000	<b>WK400750</b> 4 / 001-136.000
	350 W	350 W
	4000-10000 RPM	4000-10000 RPM
	6	6
	150 MM	150 MM
	2.5 MM	5 MM
	CE	CE
	8 424835 010911	8 424835 009779



# Pulidora Circular Rotorbital

## Rotorbital Circular Polisher

### Polidora Circular Rotorbital

**Cuerpo de ABS composite y aluminio anodizado**

**Mango ergonómico y antideslizante**

**Mango auxiliar de soporte de 2 posiciones**

**Selector de 7 velocidades**

**Función de giro rotorbital**

**Fijación del disco con velcro**

**Incluye caperuza de pulido de 180 mm**

Composite ABS and anodized aluminum body

Ergonomic and non-slip handle

2-position support auxiliary handle

7 speed selector

Rotorbital spin function

Velcro disc fixing

Includes 180 mm polish bonnet

Corpo de ABS composite e alumínio anodizado

Cabo ergonômico e antiderrapante

Cabo auxiliar de suporte de 2 posições









Selector de 7 velocidades

Função de rotação rotorbital

Fixação do disco com velcro

Inclui carapuça de polido de 180 mm



	<b>WK400110</b> 4 / 001-044.000
	1010 W
	1000-4500 RPM
	7
	180 MM
	2 MM
	M-14
	CE
	8 424835 001834

# Pulidora Circular Rotorbital

## Rotorbital Circular Polisher









### Polidora Circular Rotorbital

- Cuerpo de ABS composite y aluminio anodizado**
- Mango ergonómico y antideslizante**
- Mango auxiliar de soporte orientable**
- Selector de 7 velocidades**
- Función de giro rotorbital**
- Fijación del disco con velcro**
- Incluye caperuza de pulido de 180 mm**

- Composite ABS and anodized aluminum body
- Ergonomic and non-slip handle
- Adjustable support auxiliary handle
- 7 speed selector
- Rotorbital spin function
- Velcro disc fixing
- Includes 180 mm polish bonnet

- Corpo de ABS composite e alumínio anodizado
- Cabo ergonômico e antiderrapante
- Cabo auxiliar de suporte orientável
- Selector de 7 velocidades
- Função de rotação rotorbital
- Fixação do disco com velcro
- Inclui carapuça de polido de 180 mm



	<b>WK402120</b> 4 / 001-060.000
	1400 W
	1000-3000 RPM
	7
	180 MM
	2 MM
	M-14
	CE
	8 424835 008307

## Amoladora

### Grinder

#### Rebarbadora

**Cuerpo de ABS composite y aluminio anodizado**

**Interruptor de funcionamiento continuo**

**Mango ergonómico y antideslizante**

**Mango auxiliar de soporte de 2 posiciones**

**Protector del disco orientable**

Composite ABS and anodized aluminum body

Continuous operation switch

Ergonomic and non-slip handle

2-position support auxiliary handle

Adjustable disc protector

Corpo de ABS composite e alumínio anodizado

Interruptor de operação contínua

Cabo ergonômico e antiderrapante

Cabo auxiliar de suporte de 2 posições

Protetor do disco orientável



	<b>WK400910</b> 6 / 001-034.000
	1100 W
	12000 RPM
	125 X 22 MM
	M-14
	CE
	8 424835 007911

## Amoladora Inalámbrica

### Cordless Grinder

#### Rebarbadora Sem Fios

**Cuerpo de ABS composite y aluminio anodizado**

**Mango ergonómico y antideslizante**

**Mango auxiliar de soporte de 3 posiciones**

**Protector del disco orientable**

**No incluye batería y cargador**

Composite ABS and anodized aluminum body

Ergonomic and non-slip handle

3-position support auxiliary handle

Adjustable disc protector

Battery and charger not included

Corpo de ABS composite e alumínio anodizado

Cabo ergonômico e antiderrapante

Cabo auxiliar de suporte de 3 posições

Protetor do disco orientável

Não inclui bateria e carregador



	<b>WK403410</b> 6 / 001-042.000
	20 V
	9500 RPM
	125 X 22 MM
	M-14
	CE
	8 424835 011130



# Amoladora

## Grinder

Rebarbadora

**Cuerpo de ABS composite y aluminio anodizado**

**Mango ergonómico y antideslizante**

**Mango auxiliar de soporte de 3 posiciones**

**Cabezal orientable**

**Arranque suave**

**Protector del disco orientable**

Composite ABS and anodized aluminum body

Ergonomic and non-slip handle

3-position support auxiliary handle

Adjustable head

Soft start

Adjustable disc protector

Corpo de ABS composite e alumínio anodizado

Agarramento ergonômico antiderrapante







Cabo auxiliar de suporte de 3 posições

Cabeça ajustável

Arranque suave

Protetor do disco orientável



	<b>WK401050</b> 2 / 001-066.000
	2350 W
	6600 RPM
	230 X 22 MM
	M-14
	CE
	8 424835 009946



# Sierra Sable Inalámbrica

## Cordless Reciprocating Saw

### Serra Sabre Sem Fios

**Cuerpo de ABS composite**  
**Motor brushless sin escobillas**  
**Interruptor con botón de funcionamiento continuo**  
**Mango ergonómico y antideslizante**  
**Portasierras automático**  
**Incluye 2 hojas de sierra de 105 y 150 mm**  
**No incluye batería y cargador**

Composite ABS body  
 Brushless motor  
 Switch with continuous operation button  
 Ergonomic and non-slip handle  
 Automatic saw chuck  
 Includes 2 saw blades of 105 and 150 mm  
 Battery and charger not included

Corpo de ABS composite  
 Motor brushless sem escovas  
 Interruptor com botão de operação contínua  
 Cabo ergonômico e antiderrapante  
 Portasierras automático  
 Inclui 2 lâminas de serra de 105 e 150 mm  
 Não inclui bateria e carregador



	<b>WK403460</b> 10 / 001-042.000
	20 V
	0-3000 RPM
	18 MM
	≤ 60 MM
	≤ 6 MM
	CE
	8 424835 011185



# Sierra Sable

## Reciprocating Saw

Serra Sabre

**Cuerpo de ABS composite**

**Interruptor con botón de funcionamiento continuo**

**Mango ergonómico y antideslizante**

**Mango con protector de puño**

**Base extensible**

**Portasierres automático**

**Cabezal graduable**

**Incluye 2 hojas de sierra de 105 y 150 mm**

Composite ABS body

Switch with continuous operation button

Ergonomic and non-slip handle

Fist protector handle

Extendable base

Automatic saw chuck

Adjustable head

Includes 2 saw blades of 105 and 150 mm

Corpo de ABS composite

Interruptor com botão de operação contínua

Cabo ergonômico e antiderrapante

Cabo com protector de punho









Base extensível

Portaserras automático

Cabeçal ajustável

Inclui 2 lâminas de serra de 105 e 150 mm



	<b>WK403160</b> 6 / 001-054.000
	710 W
	0-2600 RPM
	20 MM
	≤ 115 MM
	≤ 10 MM
	0-180°
	CE
	8 424835 006709

# Disco Lija Circular

## Circular Sanding Disc

Disco Lixa Circular

  
WK501610

**Cuerpo de papel, resina y óxido de aluminio**

**Microperforado**

**Grano semiabierto**

**Fijación del disco con velcro**

Paper, resin and aluminium-oxide body

Microperforated

Semi-open grain

Velcro disc fixing





Corpo de papel, resina e óxido de alumínio

Microperforado

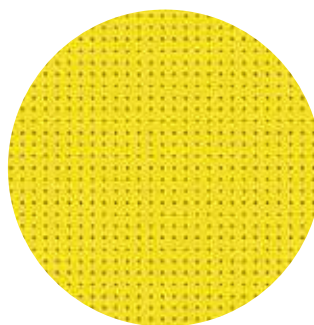
Grano semiabierto

Fixação do disco com velcro



	<b>WK300680</b> 300 / 005-001.600	<b>WK300690</b> 300 / 005-001.600	<b>WK300700</b> 300 / 005-001.600
	75 MM	75 MM	75 MM
	60	80	120
PCS	10	10	10
	8 424835 011000	8 424835 011017	8 424835 011024



# Disco Lija Circular

## Circular Sanding Disc

Disco Lixa Circular

**Cuerpo de papel, resina y óxido de aluminio**

**Microperforado**

**Grano semiabierto**

**Fijación del disco con velcro**

Paper, resin and aluminium-oxide body

Microperforated

Semi-open grain

Velcro disc fixing

Corpo de papel, resina e óxido de alumínio



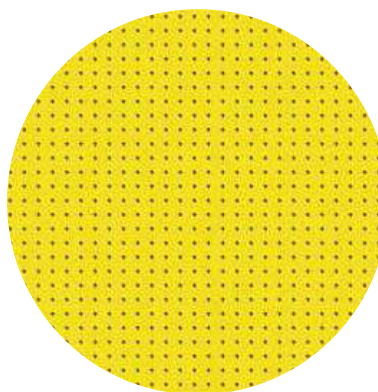

Microperforado

Grano semiabierto

Fixação do disco com velcro



  
WK400100  
WK400750  
WK401740  
WK501600  
WK500290

	<b>WK300440</b> 50 / 005-003.600	<b>WK300450</b> 50 / 005-003.600	<b>WK300460</b> 50 / 005-003.600	<b>WK300470</b> 50 / 005-003.600	<b>WK300480</b> 50 / 005-003.600
	150 MM	150 MM	150 MM	150 MM	150 MM
	60	80	100	120	150
PCS	10	10	10	10	10
	8 424835 010430	8 424835 010447	8 424835 010454	8 424835 010461	8 424835 010478

# Disco Lija Circular

## Circular Sanding Disc

Disco Lixa Circular

**Cuerpo de papel, resina y óxido de aluminio**

**Microperforado**

**Grano semiabierto**

**Fijación del disco con velcro**

Paper, resin and aluminium-oxide body

Microperforated

Semi-open grain

Velcro disc fixing

Corpo de papel, resina e óxido de alumínio

Microperforado

Grano semiabierto

Fixação do disco com velcro



**WK400030**

**WK400080**

**WK403070**

**WK403260**

**WK403250**

**WK601760**

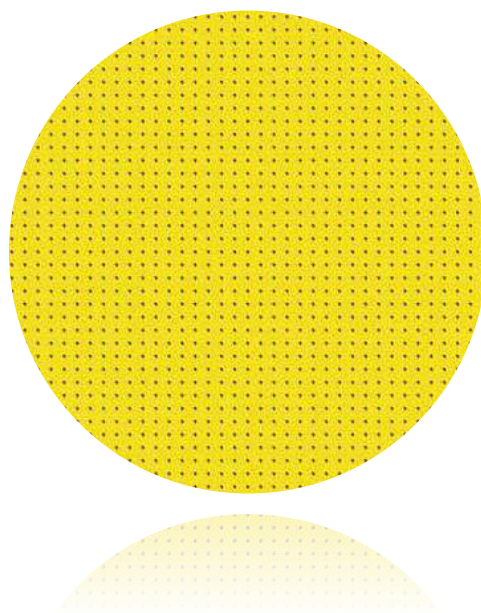

	<b>WK300770</b> 50 / 005-007.400	<b>WK300780</b> 50 / 005-007.400	<b>WK300790</b> 50 / 005-007.400
	225 MM	225 MM	225 MM
	60	80	100
PCS	10	10	10
	8 424835 010485	8 424835 010492	8 424835 010508

	<b>WK300800</b> 50 / 005-007.400	<b>WK300810</b> 50 / 005-007.400	<b>WK300820</b> 50 / 005-007.400	<b>WK300830</b> 50 / 005-007.400
	225 MM	225 MM	225 MM	225 MM
	120	150	180	220
PCS	10	10	10	10
	8 424835 010515	8 424835 010522	8 424835 010539	8 424835 010546

# Hoja Lija Triangular

## Triangular Sanding Sheet

### Folha Lixa Triangular

WK401780

**Cuerpo de papel, resina y óxido de aluminio**  
**Microperforado**  
**Grano semiabierto**  
**Fijación de la hoja con velcro**

Paper, resin and aluminium-oxyde body  
 Microperforated  
 Semi-open grain  
 Velcro sheet fixing

Corpo de papel, resina e óxido de alumínio  
 Microperforado  
 Grano semiabierto  
 Fixação da folha com velcro

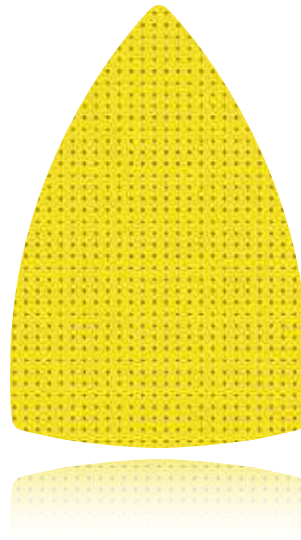

Ø I	WK300900 100 / 005-003.000	WK300910 100 / 005-003.000	WK300920 100 / 005-003.000
△	100 X 150 X 150 MM	100 X 150 X 150 MM	100 X 150 X 150 MM
■	60	80	120
PCS	10	10	10
	8 424835 011093	8 424835 011109	8 424835 011116



# Hoja Lija Rectangular

## Rectangular Sanding Sheet

### Folha Lixa Retangular

WK401760

**Cuerpo de papel, resina y óxido de aluminio**  
**Microperforado**  
**Grano semiabierto**  
**Fijación de la hoja con velcro**

Paper, resin and aluminium-oxyde body  
 Microperforated  
 Semi-open grain  
 Velcro sheet fixing

Corpo de papel, resina e óxido de alumínio  
 Microperforado  
 Grano semiabierto  
 Fixação da folha com velcro

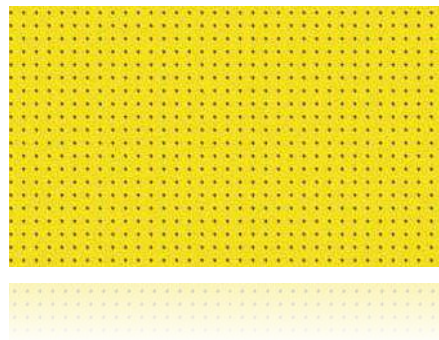

Ø I	WK300840 150 / 005-002.000	WK300850 150 / 005-002.000	WK300860 150 / 005-002.000
□	80 X 135 MM	80 X 135 MM	80 X 135 MM
■	60	80	120
PCS	10	10	10
	8 424835 011031	8 424835 011048	8 424835 011055



# Hoja Lija Rectangular

## Rectangular Sanding Sheet

### Folha Lixa Retangular

  
WK401770

**Cuerpo de papel, resina y óxido de aluminio**

**Microperforado**

**Grano semiabierto**

**Fijación de la hoja con velcro**

Paper, resin and aluminium-oxide body

Microperforated

Semi-open grain

Velcro sheet fixing





Corpo de papel, resina e óxido de alumínio

Microperforado

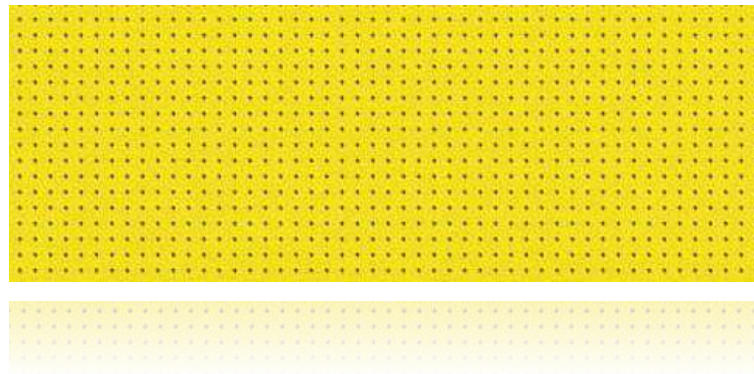
Grano semiabierto

Fixação da folha com velcro



	<b>WK300870</b> 150 / 005-002.400	<b>WK300880</b> 150 / 005-002.400	<b>WK300890</b> 150 / 005-002.400
	70 X 195 MM	70 X 195 MM	70 X 195 MM
	60	80	120
PCS	10	10	10
	8 424835 011062	8 424835 011079	8 424835 011086



## Disco Pulido Caperuza

### Bonnet Polish Disc

Disco Polido Carapuça

**Cuerpo de poliéster y algodón**

**Fijación del disco con velcro**

Polyester and cotton body

Velcro disc fixing

Corpo de poliéster e algodão

Fixação do disco com velcro



WK402120

WK400110



**WK302690**

6 / 006-004.000



180 MM



8 424835 001230

## Disco Pulido Esponja

### Sponge Polish Disc

Disco Polido Esponja

**Cuerpo de esponja de poliuretano**

**Poros grueso**

**Fijación del disco con velcro**

Poliurethane sponge body

Coarse pore

Velcro disc fixing

Corpo de esponja de poliuretano

Poros grosso

Fixação do disco com velcro



WK401090



**WK300250**

40 / 001-006.200



390 MM



45 MM



8 424835 010690

## Hoja Sierra Corte Madera Wood Cutting Sawblade Lâmina Serra Corte Madeira

**Cuerpo de acero carbono forjado**  
**Fijación de la sierra universal**

Forged carbon steel body  
Universal saw fixing

Corpo de aço carbono forjado  
Fixação da serra universal



WK403160  
WK403460



Ø l	<b>WK300190</b> 6 / 006-002.200
↕	150 MM
↔	10 MM
PCS	5
	8 424835 003333

## Hoja Sierra Corte Metal Metal Cutting Sawblade Lâmina Serra Corte Metal

**Cuerpo de acero carbono forjado**  
**Fijación de la sierra universal**

Forged carbon steel body  
Universal saw fixing

Corpo de aço carbono forjado  
Fixação da serra universal



WK403160  
WK403460



Ø l	<b>WK302170</b> 6 / 006-005.200
↕	105 MM
↔	14 MM
PCS	5
	8 424835 004507



## Atornillador Paneles-Placas Yeso

### Drywall Panel-Board Screwdriver









Aparafusador Painéis-Placas Gesso

**Cuerpo de ABS composite y aluminio anodizado**  
**Interruptor con botón de funcionamiento continuo**  
**Mango ergonómico y antideslizante**  
**Regulador de profundidad**  
**Clip de sujeción al cinturón**  
**Portapuntas magnético**  
**Función de rotación reversible**  
**Incluye correa de sujeción**

Composite ABS and anodized aluminum body  
Switch with continuous operation button  
Ergonomic and non-slip handle  
Depth regulator  
Fastening belt clip  
Magnetic bit holder  
Reversible rotation function  
Includes clamping strap

Corpo de ABS composite e alumínio anodizado  
Interruptor com botão de operação contínua  
Cabo ergonômico e antiderrapante  
Regulador de profundidade  
Clipe de sujeição ao cinto  
Porta-pontas magnético  
Função de rotação reversível  
Inclui correia de sujeição



	<b>WK400090</b> 6 / 001-046.000
	520 W
	0-4500 RPM
	HEX-6
	8 MM
	0-20 MM
	CE
	8 424835 001681

# Atornillador Paneles-Placas Yeso Inalámbrico

## Cordless Drywall Panel-Board Screwdriver

Aparafusador Painéis-Placas Gesso Sem Fios

**Cuerpo de ABS composite y aluminio anodizado**

**Motor brushless sin escobillas**

**Interruptor con botón de funcionamiento continuo**

**Mango ergonómico y antideslizante**

**Regulador de profundidad**

**Sistema integrado de luz LED de visión**

**Clip de sujeción al cinturón**

**Portapuntas magnético**

**Función de rotación reversible**

**Incluye correa de sujeción**

**No incluye batería y cargador**

Composite ABS and anodized aluminum body

Brushless motor

Switch with continuous operation button

Ergonomic and non-slip handle

Depth regulator

Integrated vision LED light system

Fastening belt clip

Magnetic bit holder

Reversible rotation function

Includes clamping strap

Battery and charger not included

Corpo de ABS composite e alumínio anodizado

Motor brushless sem escovas

Interruptor com botão de operação contínua

Cabo ergonômico e antiderrapante

Regulador de profundidade

Sistema integrado de luz LED de visão

Clipe de sujeição ao cinto









Porta-pontas magnético

Função de rotação reversível

Inclui correia de sujeição

Não inclui bateria e carregador



	<b>WK403450</b> 6 / 001-058.000
	20 V
	0-4200 RPM
	HEX-6
	8 MM
	0-10 MM
	CE
	8 424835 011178



## Atornillador Inalámbrico

### Cordless Driver

Aparafusador Sem Fios

**Cuerpo de ABS composite**

**Mango ergonómico y antideslizante**

**Indicador LED de carga de batería**

**Sistema integrado de luz LED de visión**

**Portapuntas magnético**

**Función de rotación reversible**

**Función de taladrado sin percusión**

**Incluye batería y cargador**

**Incluye 20 puntas de atornillado y 3 brocas de taladrado**

**Incluye maletín de transporte de HDPE**

Composite ABS body

Ergonomic and non-slip handle

Battery charge LED indicator

Integrated vision LED light system

Magnetic bit holder

Reversible rotation function

Drill function without impact

Includes battery and charger

Includes 20 screwdriving bits and 3 drill bits

Includes HDPE transportation case

Corpo de ABS composite

Cabo ergonômico e antiderrapante

Indicador LED de carga da bateria

Sistema integrado de luz LED de visão

Porta-pontas magnético

Função de rotação reversível

Função de perfuração sem percussão

Inclui bateria e carregador

Inclui 20 pontas de aparafusar e 3 pontas de perfuração

Inclui mala de transporte de HDPE



	<b>WK400270</b> 10 / 001-018.000
	3.6V = 2.0 AH LI-ION
	3-5 H
	180 RPM
	5 NM
	HEX-6
	≤ 20 MM
	≤ 8 MM
	≤ 8 MM
	CE
	8 424835 009236



## Atornillador Percutor Inalámbrico

### Cordless Impact Driver

Aparafusador Percussor Sem Fios

**Cuerpo de ABS composite**

**Mango ergonómico y antideslizante**

**Indicador LED de carga de batería**

**Sistema integrado de luz LED de visión**

**Cabezal graduable**

**Función de rotación reversible**

**Función de taladrado con percusión**

**Incluye 2 baterías y cargador**

**Incluye 2 puntas de atornillado**

Composite ABS body

Ergonomic and non-slip handle

Battery charge LED indicator

Integrated vision LED light system

Adjustable head

Reversible rotation function

Drill function with impact

Includes 2 batteries and charger

Includes 2 screwdriving bits

Corpo de ABS composite

Cabo ergonômico e antiderrapante

Indicador LED de carga da bateria

Sistema integrado de luz LED de visão

Cabeçal ajustável

Função de rotação reversível

Função de perfuração com percussão

Inclui 2 baterias e carregador

Inclui 2 pontas de aparafusar



	<b>WK401040</b> 10 / 001-032.000
	7.2V = 2.0 AH LI-ION
	1.5 H
	0-2300 RPM
	0-3000 IPM
	20 NM
	HEX-6
	≤ 20 MM
	≤ 8 MM
	≤ 5 MM
	≤ 8 MM
	CE
	8 424835 009748



# Taladro Atornillador-Percutor Inalámbrico

## Cordless Impact-Driver Drill

Berbequim Aparafusador-Percussor Sem Fios

**Cuerpo de ABS composite**

**Mango ergonómico y antideslizante**

**Selector de 2 rangos de revoluciones**

**Sistema integrado de luz LED de visión**

**Portabrocas automático metálico**

**Función de rotación reversible**

**Función de taladrado con y sin percusión**

**Clip de sujeción para el cinturón**

**Incluye correa de sujeción**

**No incluye batería y cargador**

Composite ABS body

Ergonomic and non-slip handle

2-speed range selector

Integrated vision LED light system

Metallic keyless chuck

Reversible rotation function

Drill function with and without impact

Fastening belt clip

Includes clamping strap

Battery and charger not included

Corpo de ABS composite

Cabo ergonômico e antiderrapante

Selector de 2 níveis de rotações

Sistema integrado de luz LED de visão

Bucha automática metálica

Função de rotação reversível













Função de perfurado com e sem percussão

Clipe de sujeição para o cinto

Inclui correia de sujeição

Não inclui bateria e carregador



	<b>WK403400</b> 10 / 001-042.000
	20 V
	0-450 / 0-1750 RPM
	0-9000 / 0-32400 IPM
	19+2
	50 NM
	≤ 13 MM
	≤ 35 MM
	≤ 13 MM
	≤ 13 MM
	6 MM
	CE
	8 424835 011123



# Taladro Martillo Percutor Impact Hammer Drill

Berbequim Martelo Percussor

**Cuerpo de ABS composite y aluminio anodizado**

**Interruptor con botón de funcionamiento continuo**

**Mango ergonómico y antideslizante**

**Mango auxiliar de soporte orientable**

**Regulador de velocidad**

**Selector de 2 rangos de revoluciones**

**Portabrocas automático**

**Función de rotación reversible**

**Función de taladrado con y sin percusión**

**Incluye guía de profundidad de taladrado de 0-200 mm**

Composite ABS and anodized aluminum body

Switch with continuous operation button

Ergonomic and non-slip handle

Adjustable support auxiliary handle

Speed regulator

2-speed range selector

Keyless chuck

Reversible rotation function

Drill function with and without impact

Includes 0-200 mm drilling depth guide

Corpo de ABS composite e alumínio anodizado

Interruptor com botão de operação contínua

Cabo ergonômico e antiderrapante

Cabo auxiliar de suporte orientável

Regulador de velocidade

Selector de 2 níveis de rotações











Bucha automática

Função de rotação reversível

Função de perfuração com e sem percussão

Inclui guia de profundidade de perfuração de 0-200 mm



	<b>WK403170</b> 5 / 001-052.000
	1050 W
	0-1100 / 0-3000 RPM
	0-52300 IPM
	2-13 MM
	≤ 40 MM
	≤ 16 MM
	≤ 20 MM
	CE
	8 424835 006617



# Taladro Martillo Demoledor

## Demolition Hammer Drill

Berbequim Martelo Demolidor

**Cuerpo de ABS composite y aluminio anodizado**

**Interruptor con botón de funcionamiento continuo**

**Mango ergonómico y antideslizante**

**Mango con protector de puño**

**Mango auxiliar de soporte orientable**

**Regulador de velocidad**

**Función de rotación reversible**

**Función de taladrado con y sin percusión**

**Función de cincelado con y sin giro**

**Indicador LED de desgaste de escobillas**

**Incluye guía de profundidad de taladrado de 0-200 mm**

**Incluye 3 brocas de hormigón 8-10-12 x 150 mm y cincel y puntero de 15 x 250 mm**

**Incluye maletín de transporte de HDPE**

Composite ABS and anodized aluminum body

Switch with continuous operation button

Ergonomic and non-slip handle

Fist protector handle

Adjustable support auxiliary handle

Speed regulator

Reversible rotation function

Drill function with and without impact

Chisel function with and without turn

LED brush wear indicator

Includes 0-200 mm drilling depth guide

Includes 3 concrete drill bits 8-10-12 x 150 mm and chisel and pointer of 15 x 250 mm

Includes HDPE transportation case

Corpo de ABS composite e alumínio anodizado

Interruptor com botão de operação contínua

Cabo ergonômico e antiderrapante

Cabo com protector de punho

Cabo auxiliar de suporte orientável

Regulador de velocidade

Função de rotação reversível

Função de perfuração com e sem percussão

Função de cincelado com e sem torção











Indicador LED de desgaste de escovas

Inclui guia de profundidade de perfuração de 0-200 mm

Inclui 3 brocas de concreto 8-10-12 x 150 mm e cincel e ponteiro de 15 x 250 mm

Inclui mala de transporte de HDPE



	<b>WK402240</b> 4 / 001-088.000
	1050 W
	0-1100 RPM
	0-4900 IPM
	3 J
	SDS PLUS
	≤ 40 MM
	≤ 16 MM
	≤ 26 MM
	CE
	8 424835 007119



# Taladro Martillo Demoledor Inalámbrico

## Cordless Demolition Hammer Drill

Berbequim Martelo Demolidor Sem Fios

**Cuerpo de ABS composite y aluminio anodizado**

**Mango ergonómico y antideslizante**

**Mango con protector de puño**

**Mango auxiliar de soporte orientable**

**Sistema integrado de luz LED de visión**

**Función de rotación reversible**

**Función de taladrado con y sin percusión**

**Función de cincelado con y sin giro**

**Incluye guía de profundidad de taladrado de 0-200 mm**

**No incluye batería y cargador**

Composite ABS and anodized aluminum body

Ergonomic and non-slip handle

Fist protector handle

Adjustable support auxiliary handle

Integrated vision LED light system

Reversible rotation function

Drill function with and without impact

Chisel function with and without turn

Includes 0-200 mm drilling depth guide

Battery and charger not included

Corpo de ABS composite e alumínio anodizado

Cabo ergonômico e antiderrapante

Cabo com protector de punho

Cabo auxiliar de suporte orientável

Sistema integrado de luz LED de visão

Função de rotação reversível

Função de perfurado com e sem percussão

Função de cincelado com e sem torção

Inclui guia de profundidade de perfuração de 0-200 mm

Não inclui bateria e carregador



	<b>WK403420</b> 4 / 001-062.000
	20 V
	0-1250 RPM
	0-4800 IPM
	3 J
	SDS PLUS
	≤ 35 MM
	≤ 14 MM
	≤ 20 MM
	CE
	8 424835 011147



**Elección de 4 funciones. Idóneo para el taladrado en superficies de madera, metal, hormigón y cemento, y el cincelado de superficies de hormigón y cemento. Inductor con embobinado de cobre. Rodamientos herméticos. Placa electrónica sellada de ABS con circuitos impresos de aluminio. Engranajes de alta precisión. Equilibrio óptimo entre motor, eje y portabrocas.**

Choice of 4 functions. Ideal for drilling into wood, metal, concrete and cement surfaces, and chiseling into concrete and cement surfaces. Armature and inductor with copper winding. Hermetic bearings. Sealed ABS electronic board with aluminum printed circuits. High precision gears. Optimal balance between motor, shaft and chuck.

Escolha de 4 funções. Ideal para perfurar em superfícies de madeira, metal, concreto e cimento, e cinzelar em superfícies de concreto e cimento. Armadura e indutor com enrolamento de cobre. Rolamentos herméticos. Placa eletrônica ABS selada com circuitos impressos em alumínio. Engrenagens de alta precisão. Ótimo equilíbrio entre motor, eixo e mandril.





# Taladro Martillo Demoledor

## Demolition Hammer Drill

Berbequim Martelo Demolidor

**Cuerpo de ABS composite y aluminio anodizado**

**Mango ergonómico y antideslizante**

**Mango con protector de puño**

**Mango auxiliar de soporte orientable**

**Selector de 6 velocidades**

**Sistema antivibración**

**Función de taladrado con y sin percusión**

**Función de cincelado con y sin giro**

**Incluye guía de profundidad de taladrado de 0-200 mm**

**Incluye grasa lubricante de 300 ml**

**Incluye 3 brocas de hormigón de 8-10-12 x 150 mm y cincel de 14 x 250 mm**

**Incluye maletín de transporte de HDPE**

Composite ABS and anodized aluminum body

Ergonomic and non-slip handle

Fist protector handle

Adjustable support auxiliary handle

6 speed selector

Anti-vibration system

Drill function with and without impact

Chisel function with and without turn

Includes 0-200 mm drilling depth guide

Includes 300 ml lubricating grease

Includes 3 concrete drill bits of 8-10-12 x 150 mm and chisel of 14 x 250 mm

Includes HDPE transportation case

Corpo de ABS composite e alumínio anodizado

Cabo ergonômico e antiderrapante

Cabo com protector de punho

Cabo auxiliar de suporte orientável

Selector de 6 velocidades

Sistema antivibração

Função de perfuração com e sem percussão

Função de cincelado com e sem torção

Inclui guia de profundidade de perfuração de 0-200 mm

Inclui 300 ml de graxa lubrificante

Inclui 3 brocas de concreto de 8-10-12 x 150 mm e cinzel de 14 x 250 mm

Inclui mala de transporte de HDPE



	<b>WK403510</b> 2 / 001-108.000
	1200 W
	0-1050 RPM
	0-4200 IPM
	6
	5 J
	SDS PLUS
	≤ 40 MM
	≤ 14 MM
	≤ 32 MM
	CE
	8 424835 011253



# Taladro Martillo Demoledor

## Demolition Hammer Drill

Berbequim Martelo Demolidor

**Cuerpo de ABS composite y aluminio anodizado**

**Mango ergonómico y antideslizante**

**Mango con protector de puño**

**Mango auxiliar de soporte orientable**

**Selector de 6 velocidades**

**Sistema antivibración**

**Función de taladrado con percusión**

**Función de cincelado con y sin giro**

**Indicador LED de desgaste de escobillas**

**Incluye guía de profundidad de taladrado de 0-200 mm**

**Incluye grasa lubricante de 300 ml**

**Incluye broca de hormigón de 20 x 400 mm y cincel de 18 x 400 mm**

**Incluye maletín de transporte de HDPE**

Composite ABS and anodized aluminum body

Ergonomic and non-slip handle

Fist protector handle

Adjustable support auxiliary handle

6 speed selector

Anti-vibration system

Drill function with impact

Chisel function with and without turn

LED brush wear indicator

Includes 0-200 mm drilling depth guide

Includes 300 ml lubricating grease

Includes concrete drill bit of 20 x 400 mm and chisel of 18 x 400 mm

Includes HDPE transportation case

Corpo de ABS composite e alumínio anodizado

Cabo ergonômico e antiderrapante

Cabo com protector de punho

Cabo auxiliar de suporte orientável

Selector de 6 velocidades

Sistema antivibração

Função de perfuração com percussão

Função de cincelado com e sem torção

Indicador LED de desgaste de escovas











Inclui guia de profundidade de perfuração de 0-200 mm

Inclui 300 ml de graxa lubrificante

Inclui broca de concreto de 20 x 400 mm e cinzel de 18 x 400 mm

Inclui mala de transporte de HDPE



	<b>WK401020</b> 2 / 001-198.000
	1100 W
	300-760 RPM
	1950-4850 IPM
	6
	7 J
	SDS MAX
	≤ 35 MM
	CE
	8 424835 009267



# Martillo Demoledor

## Demolition Hammer

Martelo Demolidor

**Cuerpo de ABS composite y aluminio anodizado**

**Mango ergonómico y antideslizante**

**Mango con protector de puño**

**Mango auxiliar de soporte orientable**

**Selector de 6 velocidades**

**Sistema antivibración**

**Función de cincelado con y sin giro**

**Indicador LED de desgaste de escobillas**

**Incluye grasa lubricante de 300 ml**

**Incluye cincel de 18 x 400 mm**

**Incluye maletín de transporte de HDPE**

Composite ABS and anodized aluminum body

Ergonomic and non-slip handle

Fist protector handle

Adjustable support auxiliary handle

6 speed selector

Anti-vibration system

Chisel function with and without turn

LED brush wear indicator

Includes 300 ml lubricating grease

Includes chisel of 18 x 400 mm

Includes HDPE transportation case

Corpo de ABS composite e alumínio anodizado

Cabo ergonômico e antiderrapante

Cabo com protector de punho

Cabo auxiliar de suporte orientável

Selector de 6 velocidades

Sistema antivibração

Função de cincelado com e sem torção

Indicador LED de desgaste de escovas

Inclui 300 ml de graxa lubrificante

Inclui cinzel de 18 x 400 mm

Inclui mala de transporte de HDPE



	<b>WK400610</b> 2 / 001-178.000
	1200 W
	2700-3700 IPM
	6
	14 J
	SDS MAX
	CE
	8 424835 007058



# Martillo Demoledor

## Demolition Hammer

### Martelo Demolidor

**Cuerpo de ABS composite y aluminio anodizado**

**Mango ergonómico y antideslizante**

**Mango con protector de puño**

**Mango auxiliar de soporte orientable**

**Selector de 6 velocidades**

**Sistema antivibración**

**Función de cincelado con y sin giro**

**Indicador LED de desgaste de escobillas**

**Incluye grasa lubricante de 300 ml**

**Incluye cincel de 18 x 400 mm**

**Incluye maletín de transporte de HDPE**

Composite ABS and anodized aluminum body

Ergonomic and non-slip handle

Fist protector handle

Adjustable support auxiliary handle

6 speed selector

Anti-vibration system

Chisel function with and without turn

LED brush wear indicator

Includes 300 ml lubricating grease

Includes chisel of 18 x 400 mm

Includes HDPE transportation case

Corpo de ABS composite e alumínio anodizado

Cabo ergonômico e antiderrapante

Cabo com protetor de punho

Cabo auxiliar de suporte orientável

Selector de 6 velocidades

Sistema antivibração

Função de cincelado com e sem torção

Indicador LED de desgaste de escovas

Inclui 300 ml de graxa lubrificante

Inclui cinzel de 18 x 400 mm

Inclui mala de transporte de HDPE



	<b>WK400240</b> 1 / 001-248.000
	1500 W
	1000-1900 IPM
	6
	25 J
	SDS MAX
	CE
	8 424835 007713



## Martillo Demoledor

### Demolition Hammer

Martelo Demolidor

- Cuerpo de ABS composite y aluminio anodizado
- Interruptor con botón de funcionamiento continuo
- Mango ergonómico y antideslizante
- Mango con protector de puño
- Mango auxiliar de soporte orientable
- Sistema antivibración
- Función de cincelado sin giro
- Incluye grasa lubricante de 300 ml
- Incluye cincel y puntero de 30 x 410 mm
- Incluye maletín de transporte de HDPE

Composite ABS and anodized aluminum body  
Switch with continuous operation button  
Ergonomic and non-slip handle  
Fist protector handle  
Adjustable support auxiliary handle  
Anti-vibration system  
Chisel function without turn  
Includes 300 ml lubricating grease  
Includes chisel and pointer of 30 x 410 mm  
Includes HDPE transportation case

Corpo de ABS composite e alumínio anodizado  
Interruptor com botão de operação contínua  
Cabo ergonômico e antiderrapante  
Cabo com protector de punho  
Cabo auxiliar de suporte orientável  
Sistema antivibração  
Função de cinzelado sem torção  
Inclui 300 ml de graxa lubrificante  
Inclui cinzel e ponteiro de 30 x 410 mm  
Inclui mala de transporte de HDPE



	<b>WK403500</b> 1 / 001-340.000
	1700 W
	1500 IPM
	50 J
	HEX-30
	CE
	8 424835 011246

## Martillo Demoledor

### Demolition Hammer

Martelo Demolidor

- Cuerpo de ABS composite y aluminio anodizado
- Mango ergonómico y antideslizante
- Sistema antivibración
- Función de cincelado sin giro
- Incluye grasa lubricante de 300 ml
- Incluye cincel y puntero de 28 x 410 mm

Composite ABS and anodized aluminum body  
Ergonomic and non-slip handle  
Anti-vibration system  
Chisel function without turn  
Includes 300 ml lubricating grease  
Includes chisel and pointer of 28 x 410 mm

Corpo de ABS composite e alumínio anodizado  
Cabo ergonômico e antiderrapante  
Sistema antivibração  
Função de cinzelado sem torção  
Inclui 300 ml de graxa lubrificante  
Inclui cinzel e ponteiro de 28 x 410 mm



	<b>WK403200</b> 1 / 001-630.000
	2200 W
	950 IPM
	80 J
	HEX-28
	CE
	8 424835 009670

## Carro Martillo Demoledor

### Demolition Hammer Trolley

Carro Martelo Demolidor

**Cuerpo de acero carbono forjado**

**Ruedas de poliuretano de 200 mm**

**Incluye 4 portacinceles y punteros**

Forged carbon steel body

Polyurethane wheels of 200 mm

Includes 4 chisel and pointer holders

Corpo de aço carbono forjado

Rodas de poliuretano de 200 mm

Inlcui 4 porta-cinzeis e ponteiros



WERKU  
WK403200

	<b>WK403190</b> 1 / 001-056.000
	135 KG
	1065 MM
	485 MM
	8 424835 009663

## Expositor Taladros Martillos Demoledores

### Demolition Hammer Drills Display Stand

Expositor Berbequims Martelos Demolidores

**Cuerpo de acero carbono forjado**

**Capacidad para 9 taladros martillos demoledores**

Forged carbon steel body

Capacity for 9 demolition hammers drills

Corpo de aço carbono forjado

Capacidade para 9 berbequims martelos demolidores



WERKU  
WK402240  
WK403420  
WK403510  
WK401020  
WK400610  
WK400240  
WK403500  
WK403200

	<b>WK400230</b> 1 / 001-066.000
	1500 MM
	640 MM
	8 424835 009519

# Soporte Polipasto

## Hoist Frame

Suporte Garibalde

**Cuerpo de acero inoxidable**

**Compatible con polipastos eléctricos universales**

**Compatible con andamios de estructura redonda universales**

**Braço giratório em 180 grados**

Stainless-steel body

Compatible with universal electric hoists

Compatible with universal round frame scaffolds

180 degree rotating arm

Corpo de aço inoxidável

Compatível com garibaldes elétricos universais

Compatível com andaimes de armação redonda universais

Braço giratório em 180 graus



WK400160

WK400170

WK400220

WK400540

WK400550



	<b>WK400510</b> 4 / 001-044.000
	600 KG
	750 MM
	48 MM
	0-180°
	TÜV GS
	8 424835 000714

# Polipasto Cable

## Cable Hoist

Garibalde Cabo

**Cuerpo de aluminio anodizado y acero carbono forjado**

**Cable de acero carbono forjado galvanizado**

**Interruptor electromagnético con función de parada de emergencia**

**Función con polea de reenvío**

**Función de freno de tope automático para subida y bajada**

**Función de protección térmica con apagado de seguridad del motor**

**Incluye 2 abrazaderas de soporte**

**Incluye gancho de seguridad con contrapeso**

**Incluye gancho de seguridad con polea de reenvío**

Anodized aluminum and forged carbon steel body

Galvanized forged carbon steel cable

Electromagnetic switch with emergency stop function

Forward-pulley function

Automatic stop brake function for raising and lowering

Thermal protection function with motor safety shutdown

Includes 2 support brackets

Includes counterweight snap hook

Includes safety hook with forward-pulley

Corpo de alumínio anodizado e aço carbono forjado

Cabo de aço carbono forjado galvanizado

Interruptor eletromagnético com função de parada de emergência

Função com roldana de reenvio

Função de freio de parada automática para levantar e abaixar

Função de proteção térmica com desligamento de segurança do motor

Inclui 2 braçadeiras de suporte

Inclui gancho de segurança com contrapeso

Inclui gancho de segurança com roldana de reenvio



	<b>WK400160</b> 2 / 001-098.000	<b>WK400170</b> 2 / 001-138.000	<b>WK400220</b> 2 / 001-168.000	<b>WK400540</b> 2 / 001-238.000	<b>WK400550</b> 1 / 001-328.000
	100 KG / 200 KG	200 KG / 400 KG	300 KG / 600 KG	400 KG / 800 KG	500 KG / 1000 KG
	450 W	750 W	1050 W	1350 W	1600 W
	2500 RPM	2500 RPM	2500 RPM	2500 RPM	2500 RPM
	8 MPM / 4 MPM	8 MPM / 4 MPM	10 MPM / 5 MPM	10 MPM / 5 MPM	10 MPM / 5 MPM
	18 M / 9 M	22 M / 11 M	22 M / 11 M	22 M / 11 M	22 M / 11 M
	18 M	22 M	22 M	22 M	22 M
	3 MM	3.8 MM	4.5 MM	5 MM	5.6 MM
	IP54	IP54	IP54	IP54	IP54
	CE	CE	CE	CE	CE
	8 424835 505042	8 424835 510053	8 424835 510046	8 424835 000738	8 424835 000745





# Proyector LED Luz Trabajo

## Work Light LED Projector

### Projektor LED Luz Trabalho

**Cuerpo de aluminio anodizado, cristal y acero carbono forjado**

**Cristal de seguridad templado**

**Mango ergonómico y antideslizante**

**Compatible para uso interior y exterior**

**Base graduable y antideslizante**

Anodized aluminium, glass and forged carbon steel body

Tempered safety glass

Ergonomic and non-slip handle

Compatible for indoor and outdoor use

Adjustable and non-slip base

Corpo de alumínio anodizado, cristal e aço carbono forjado

Cristal de segurança temperado

Cabo ergonômico e antiderrapante

Compatível para uso interior e exterior

Base graduável e antiderrapante



	<b>WK402150</b> 4 / 001-032.000	<b>WK402160</b> 4 / 001-042.000	<b>WK403210</b> 2 / 001-068.000	<b>WK403220</b> 2 / 001-082.000	<b>WK403290</b> 2 / 001-108.000
	30 W	50 W	100 W	150 W	200 W
	SMD / 72 X EPISTAR	SMD / 120 X EPISTAR	SMD / 240 X EPISTAR	SMD / 360 X EPISTAR	SMD / 480 X EPISTAR
	2700 LM	4500 LM	9000 LM	11000 LM	18000 LM
	6500 K	6500 K	6500 K	6500 K	6500 K
	130°	130°	130°	130°	130°
	20 M	30 M	40 M	50 M	60 M
	200 X 170 X 60 MM	240 X 200 X 60 MM	280 X 250 X 80 MM	360 X 290 X 80 MM	430 X 350 X 100 MM
	0-180°	0-180°	0-180°	0-180°	0-180°
	10000 H	10000 H	10000 H	10000 H	10000 H
	IP65	IP65	IP65	IP65	IP65
	F	F	F	F	F
	CE	CE	CE	CE	CE
	8 424835 008000	8 424835 008017	8 424835 009038	8 424835 009045	8 424835 010942



# Proyector LED Luz Trabajo Inalámbrico

## Cordless Work Light LED Projector

### Projektor LED Luz Trabalho Sem Fios

**Cuerpo de aluminio anodizado, cristal y acero carbono forjado**

**Cristal de seguridad templado**

**Mango ergonómico y antideslizante**

**Compatible para uso interior y exterior**

**Base graduable y antideslizante**

**Incluye batería, cargador de enchufe y cargador de coche**

Anodized aluminium, glass and forged carbon steel body

Tempered safety glass

Ergonomic and non-slip handle

Compatible for indoor and outdoor use

Adjustable and non-slip base

Includes battery, plug charger and car charger

Corpo de alumínio anodizado, cristal e aço carbono forjado

Cristal de segurança temperado

Cabo ergonômico e antiderrapante

Compatível para uso interior e exterior

Base graduável e antiderrapante

Inclui bateria, carregador de ficha e carregador de automóvel



	<b>WK403320</b> 10 / 001-028.000	<b>WK403390</b> 8 / 001-034.000
	30 W	50 W
	3.7V = 5.2 AH LI-ION	3.7V = 5.6 AH LI-ION
	4 H	4 H
	SMD / 60 X EPISTAR	SMD / 100 X EPISTAR
	2100 LM	3500 LM
	6500 K	6500 K
	120°	120°
	20 M	30 M
	200 X 150 X 30 MM	240 X 170 X 30 MM
	0-180°	0-180°
	10000 H	10000 H
	IP54	IP54
	G	G
	CE	CE
	8 424835 010959	8 424835 010966



# Enrollacables Alargador

## Extension Cable Roller

Enrola Cabos Prolongador

**Cuerpo de ABS composite y acero carbono forjado**

**Mango ergonómico y antideslizante**

**Tapas de protección impermeables con cierre automático**

**Función de protección contra el sobrecalentamiento**

**Compatible para uso interior y exterior**

**Manivela de recogida de cable**

Composite ABS and forged carbon steel body

Ergonomic and non-slip handle

Waterproof self-closing protective covers

Overheat protection function

Compatible for indoor and outdoor use

Cable take-up crank

Corpo de ABS composite e aço carbono forjado

Cabo ergonômico e antiderrapante









Coberturas protetoras de fechamento automático à prova d'água

Função de proteção contra superaquecimento

Compatível para uso interno e externo

Manivela de coleta de cabo



	<b>WK403360</b> 1 / 001-032.000	<b>WK403370</b> 1 / 001-058.000
	25 M	50 M
	4	4
	H05RR-F 3G 1.5MM <sup>2</sup>	H05RR-F 3G 1.5MM <sup>2</sup>
	≤ 3200 W	≤ 3200 W
	IP44	IP44
	CE	CE
	8 424835 010867	8 424835 010874

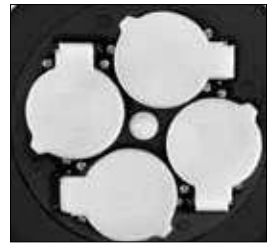

**Apto para el uso en entornos húmedos. Protección contra cuerpos sólidos de más de 1 mm de diámetro y contra las salpicaduras de agua procedentes de todas las direcciones.**  
*Suitable for use in humid environments. Protection against solid bodies of more than 1 mm in diameter and against water splashes from all directions.*

*Adequado para uso em ambientes húmedos. Proteção contra corpos sólidos com mais de 1 mm de diâmetro e contra salpicos de água provenientes de todas as direções.*



# Herramientas Neumáticas y Airless

## Pneumatic and Airless Tools

### Ferramentas Pneumáticas e Airless



## Pistola Pintar Gravedad Retoques HVLP-I

### HVLP-I Retouch Gravity Paint Spray Gun

Pistola Pintar Gravidade Retoques HVLP-I

**Cuerpo de aluminio anodizado**

**Acabado cromado y pulido**

**Depósito de HDPE**

**Mango ergonómico y antideslizante**

**Regulador de abanico**

**Regulador de fluido**

**Regulador de presión**

**Incluye varilla de limpieza de 100 mm**

Anodized aluminum body

Polished chrome finish

HDPE tank

Ergonomic and non-slip handle

Pattern regulator

Fluid regulator

Pressure regulator

Includes 100 mm cleaning rod

Corpo de alumínio anodizado

Acabamento cromado e polido

Tanque de HDPE

Cabo ergonômico e antiderrapante

Regulador de leque

Regulador de fluido

Regulador de pressão

Inclui vareta de limpeza de 100 mm



	<b>WK500730</b> 20 / 001-014.000
	≥ 1.5 HP / 50 L
	2.5 - 3.5 BAR
	8 BAR
	BSP 1/4"
	100 LPM
	0.8 MM
	125 ML
	CE
	8 424835 001711



## Pistola Pintar Gravedad HVLP-I

### HVLP-I Gravity Paint Spray Gun

Pistola Pintar Gravidade HVLP-I

**Cuerpo de aluminio anodizado**

**Acabado cromado y pulido**

**Depósito de HDPE**

**Mango ergonómico y antideslizante**

**Regulador de abanico**

**Regulador de fluido**

**Regulador de presión**

**Incluye varilla de limpieza de 100 mm**

Anodized aluminum body

Polished chrome finish

HDPE tank

Ergonomic and non-slip handle

Pattern regulator

Fluid regulator

Pressure regulator

Includes 100 mm cleaning rod

Corpo de alumínio anodizado

Acabamento cromado e polido

Tanque de HDPE

Cabo ergonômico e antiderrapante

Regulador de leque

Regulador de fluido

Regulador de pressão

Inclui vareta de limpeza de 100 mm



	<b>WK500740</b> 10 / 001-018.000
	≥ 1.5 HP / 50 L
	3 - 4 BAR
	8 BAR
	BSP 1/4"
	175 LPM
	1.7 MM
	600 ML
	CE
	8 424835 001728



# Pistola Pintar Succión HVLP-I

## HVLP-I Suction Paint Spray Gun

### Pistola Pintar Sucção HVLP-I

Cuerpo de aluminio anodizado

Acabado cromado y pulido

Depósito de aluminio anodizado

Mango ergonómico y antideslizante

Regulador de abanico

Regulador de fluido

Regulador de presión

Incluye varilla de limpieza de 100 mm

Anodized aluminum body

Polished chrome finish

Anodized aluminum tank

Ergonomic and non-slip handle

Pattern regulator

Fluid regulator

Pressure regulator

Includes 100 mm cleaning rod

Corpo de alumínio anodizado

Acabamento cromado e polido

Tanque de alumínio anodizado

Cabo ergonômico e antiderrapante











Regulador de leque

Regulador de fluido

Regulador de pressão

Inclui vareta de limpeza de 100 mm



	<b>WK500750</b> 10 / 001-020.000
	≥ 2 HP / 50 L
	3 - 4 BAR
	8 BAR
	BSP 1/4"
	175 LPM
	1.7 MM
	1000 ML
	CE
	8 424835 001735

**HVLP-I (alto volumen a baja presión) reduce el consumo del producto a pulverizar un 30%, acorta el tiempo de trabajo un 20%, disminuye el consumo de aire un 15% y genera una buena calidad de pulverización y acabado.**

HVLP-I (high volume at low pressure) reduces the consumption of the product to be sprayed by 30%, shortens the working time by 20%, reduces air consumption by 15% and generates a good quality of spray and finish.

HVLP-I (alto volumen a baixa pressão) reduz o consumo do produto a ser pulverizado em 30%, reduz o tempo de trabalho em 20%, reduz o consumo de ar em 15% e gera uma boa qualidade de pulverização e acabamento.



## Pistola Pintar Gravedad Retoques HVLP-II

### HVLP-II Retouch Gravity Paint Spray Gun

Pistola Pintar Gravidade Retoques HVLP-II

**Cuerpo de aluminio anodizado**

**Acabado cromado mate**

**Depósito de HDPE**

**Mango ergonómico y antideslizante**

**Regulador de abanico**

**Regulador de fluido**

**Regulador de presión**

**Incluye varilla de limpieza de 100 mm**

Anodized aluminum body

Matt chrome finish

HDPE tank

Ergonomic and non-slip handle

Pattern regulator

Fluid regulator

Pressure regulator

Includes 100 mm cleaning rod

Corpo de alumínio anodizado

Acabamento cromado mate

Tanque de HDPE

Cabo ergonômico e antiderrapante

Regulador de leque

Regulador de fluido

Regulador de pressão

Inclui vareta de limpeza de 100 mm



## Pistola Pintar Gravedad HVLP-II

### HVLP-II Gravity Paint Spray Gun

Pistola Pintar Gravidade HVLP-II

**Cuerpo de aluminio anodizado**

**Acabado cromado mate**

**Depósito de HDPE**

**Mango ergonómico y antideslizante**

**Regulador de abanico**

**Regulador de fluido**

**Regulador de presión**

**Incluye varilla de limpieza de 100 mm**

Anodized aluminum body

Matt chrome finish

HDPE tank

Ergonomic and non-slip handle

Pattern regulator

Fluid regulator

Pressure regulator

Includes 100 mm cleaning rod

Corpo de alumínio anodizado

Acabamento cromado mate

Tanque de HDPE

Cabo ergonômico e antiderrapante











Regulador de leque

Regulador de fluido











Regulador de pressão

Inclui vareta de limpeza de 100 mm



	<b>WK501100</b> 30 / 001-020.000
	≥ 1.5 HP / 50 L
	1 - 2.5 BAR
	8 BAR
	BSP 1/4"
	75 LPM
	0.8 MM
	125 ML
	CE
	8 424835 009410



	<b>WK501080</b> 10 / 001-024.000
	≥ 1.5 HP / 50 L
	1.5 - 3 BAR
	8 BAR
	BSP 1/4"
	125 LPM
	1.7 MM
	600 ML
	CE
	8 424835 009397





# Pistola Pintar Succión HVLP-II

## HVLP-II Suction Paint Spray Gun

### Pistola Pintar Sucção HVLP-II

**Cuerpo de aluminio anodizado**  
**Acabado cromado mate**  
**Depósito de aluminio anodizado**  
**Mango ergonómico y antideslizante**  
**Regulador de abanico**  
**Regulador de fluido**  
**Regulador de presión**  
**Incluye varilla de limpieza de 100 mm**

Anodized aluminum body  
 Matt chrome finish  
 Anodized aluminum tank  
 Ergonomic and non-slip handle  
 Pattern regulator  
 Fluid regulator  
 Pressure regulator  
 Includes 100 mm cleaning rod

Corpo de alumínio anodizado  
 Acabamento cromado mate  
 Tanque de alumínio anodizado  
 Cabo ergonômico e antiderrapante  
 Regulador de leque  
 Regulador de fluido  
 Regulador de pressão  
 Inclui vareta de limpeza de 100 mm



	<b>WK501090</b> 10 / 001-026.000
	≥ 2 HP / 50 L
	1.5 - 3 BAR
	8 BAR
	BSP 1/4"
	125 LPM
	1.7 MM
	1000 ML
	CE
	8 424835 009403

**HVLP-II (alto volumen a baja presión) reduce el consumo del producto a pulverizar un 40%, acorta el tiempo de trabajo un 30%, disminuye el consumo de aire un 40% y genera una buena calidad de pulverización y acabado.**

HVLP-II (high volume at low pressure) reduces the consumption of the product to be sprayed by 40%, shortens the working time by 30%, reduces air consumption by 40% and generates a good quality of spray and finish.

HVLP-II (alto volumen a baixa pressão) reduz o consumo do produto a ser pulverizado em 40%, reduz o tempo de trabalho em 30%, reduz o consumo de ar em 40% e gera uma boa qualidade de pulverização e acabamento.



## Pistola Pintar Gravedad Retoques HVLP-III

### HVLP-III Retouch Gravity Paint Spray Gun

Pistola Pintar Gravidade Retoques HVLP-III

**Cuerpo de aluminio anodizado**

**Acabado electroforético**

**Depósito de HDPE**

**Mango ergonómico y antideslizante**

**Regulador de abanico**

**Regulador de fluido**

**Regulador de presión**

**Incluye varilla de limpieza de 100 mm**

**Incluye maletín de transporte de aluminio anodizado**

Anodized aluminum body

Electrophoretic finish

HDPE tank

Ergonomic and non-slip handle

Pattern regulator

Fluid regulator

Pressure regulator

Includes 100 mm cleaning rod

Includes anodized aluminum transportation case

Corpo de alumínio anodizado

Acabamento eletroforético

Tanque de HDPE

Cabo ergonômico e antiderrapante

Regulador de leque

Regulador de fluido

Regulador de pressão

Inclui vareta de limpeza de 100 mm

Inclui mala de transporte de alumínio anodizado



## Pistola Pintar Gravedad HVLP-III

### HVLP-III Gravity Paint Spray Gun

Pistola Pintar Gravidade HVLP-III

**Cuerpo de aluminio anodizado**

**Acabado electroforético**

**Depósito de HDPE**

**Mango ergonómico y antideslizante**

**Regulador de abanico**

**Regulador de fluido**

**Regulador de presión**

**Incluye varilla de limpieza de 100 mm**

**Incluye maletín de transporte de aluminio anodizado**

Anodized aluminum body

Electrophoretic finish

HDPE tank

Ergonomic and non-slip handle

Pattern regulator

Fluid regulator

Pressure regulator

Includes 100 mm cleaning rod

Includes anodized aluminum transportation case

Corpo de alumínio anodizado

Acabamento eletroforético

Tanque de HDPE

Cabo ergonômico e antiderrapante

Regulador de leque











Regulador de fluido

Regulador de pressão











Inclui vareta de limpeza de 100 mm

Inclui mala de transporte de alumínio anodizado



	<b>WK501000</b> 5 / 001-0054.000
	≥ 1.5 HP / 50 L
	1 - 2.5 BAR
	10 BAR
	BSP 1/4"
	50 LPM
	0.8 / 1.0 MM
	125 ML
	CE
	8 424835 009373



	<b>WK500470</b> 5 / 001-066.000
	≥ 1.5 HP / 50 L
	1.5 - 3 BAR
	10 BAR
	BSP 1/4"
	100 LPM
	1.3 / 1.5 MM
	600 ML
	CE
	8 424835 007966



# Pistola Pintar Succión HVLP-III

## HVLP-III Suction Paint Spray Gun

Pistola Pintar Sucção HVLP-III

**Cuerpo de aluminio anodizado**

**Acabado electroforético**

**Depósito de aluminio anodizado**

**Mango ergonómico y antideslizante**

**Regulador de abanico**

**Regulador de fluido**

**Regulador de presión**

**Incluye varilla de limpieza de 100 mm**

**Incluye maletín de transporte de aluminio anodizado**

Anodized aluminum body

Electrophoretic finish

Anodized aluminum tank

Ergonomic and non-slip handle

Pattern regulator

Fluid regulator

Pressure regulator

Includes 100 mm cleaning rod

Includes anodized aluminum transportation case

Corpo de alumínio anodizado

Acabamento eletroforético

Tanque de alumínio anodizado

Cabo ergonômico e antiderrapante

Regulador de leque

Regulador de fluido

Regulador de pressão

Inclui vareta de limpeza de 100 mm











Inclui mala de transporte de alumínio anodizado



**HVLP-III (alto volumen, baja presión) reduce el consumo del producto a pulverizar un 50%, acorta el tiempo de trabajo un 40%, disminuye el consumo de aire un 50% y genera una excelente calidad de pulverización y acabado, todo ello con una baja presión de fluido.**

HVLP-III (high volume, low pressure) reduces the consumption of the product to be sprayed by 50%, shortens the working time by 40%, reduces air consumption by 50% and generates an excellent quality of spray and finish.

HVLP-III (alto volume, baixa pressão) reduz o consumo do produto a ser pulverizado em 50%, reduz o tempo de trabalho em 40%, reduz o consumo de ar em 50% e gera uma qualidade excelente de pulverização e acabamento.

	<b>WK500480</b> 5 / 001-068.000
	≥ 2 HP / 50 L
	1.5 - 3 BAR
	10 BAR
	BSP 1/4"
	100 LPM
	1.3 / 1.5 MM
	1000 ML
	CE
	8 424835 007973



# Pistola Pintar Gravedad Gotelé

## Gravity Hopper Paint Spray Gun

Pistola Pintar Gravidade Gotelé

**Cuerpo de aluminio anodizado**

**Acabado cromado y pulido**

**Depósito con asa de HDPE**

**Gatillo con fijación de funcionamiento continuo**

**Mango ergonómico y antideslizante**

**Regulador de fluido**

**Regulador de presión con válvula integrada de corte de aire**

Anodized aluminum body

Polished chrome finish

HDPE tank with handle

Trigger with continuous operation lock

Ergonomic and non-slip handle

Fluid regulator

Pressure regulator with integrated air cut valve

Corpo de alumínio anodizado

Acabamento cromado e polido

Tanque com alça de HDPE











Gatilho com bloqueio de operação contínua

Cabo ergonômico e antiderrapante

Regulador de fluido

Regulador de pressão com válvula integrada de corte de ar



	<b>WK500660</b> 6 / 001-020.000
	≥ 2 HP / 100 L
	4 - 8 BAR
	8 BAR
	BSP 1/4"
	300 LPM
	4 / 6 / 8 MM
	6000 ML
	CE
	8 424835 001766

**Recomendable para trabajos en superficies de hasta 500 m<sup>2</sup>. Compatible con gotelés, yesos, pétreos, estucos y líquidos de viscosidad alta.**

Recommended for works on surfaces up to 500 m<sup>2</sup>. Compatible with stipples, plasters, petrous paints, stuccos and high viscosity liquids.

Recomendado para trabalhos em superfícies de até 500 m<sup>2</sup>. Compatível com gotelés, rebocos, pedregosos, gessos e líquidos de alta viscosidade.



# Juego Pistolas Pintar Gravedad HVLP-I

## HVLP-I Gravity Paint Spray Gun Set

Jogo Pistolas Pintar Gravidade HVLP-I

**Cuerpo de acero carbono forjado**

**Acabado cromado y pulido**

**Depósito de HDPE**

**Mango ergonómico y antideslizante**

**Regulador de abanico**

**Regulador de fluido**

**Regulador de presión**

**Incluye manómetro de 0-10 bar**

**Incluye varilla de limpieza de 100 mm**

**Incluye maletín de transporte de HDPE**

Forged carbon steel body

Polished chrome finish

HDPE tank

Ergonomic and non-slip handle

Pattern regulator

Fluid regulator

Pressure regulator

Includes 0-10 bar manometer

Includes 100 mm cleaning rod

Includes HDPE transportation case

Corpo de aço carbono forjado

Acabamento cromado e polido

Tanque de HDPE

Cabo ergonômico e antiderrapante

Regulador de leque

Regulador de fluido

Regulador de pressão

Inclui manômetro de 0-10 bar

Inclui vareta de limpeza de 100 mm

Inclui mala de transporte de HDPE



	<b>WK500230</b> 10 / 001-032.000
	≥ 1.5 HP / 50 L
	2.5 - 3.5 / 3 - 4 BAR
	8 BAR
	BSP 1/4"
	100 / 175 LPM
	0.8 / 1.7 MM
	125 / 600 ML
	CE
	8 424835 006426

**HVLP-I (alto volumen a baja presión) reduce el consumo del producto a pulverizar un 30%, acorta el tiempo de trabajo un 20%, disminuye el consumo de aire un 15% y genera una buena calidad de pulverización y acabado.**

HVLP-I (high volume at low pressure) reduces the consumption of the product to be sprayed by 30%, shortens the working time by 20%, reduces air consumption by 15% and generates a good quality of spray and finish.

HVLP-I (alto volumen a baixa pressão) reduz o consumo do produto a ser pulverizado em 30%, reduz o tempo de trabalho em 20%, reduz o consumo de ar em 15% e gera uma boa qualidade de pulverização e acabamento.



## Juego Paso Fluido

### Fluid Nozzle Set

Jogo Passagem Fluido





  
WK500730

**Cuerpo de acero inoxidable**  
**Incluye pico fluido, boquilla y aguja**

Stainless-steel body  
Includes cap, nozzle and needle

Corpo de aço inoxidável  
Inclui bico fluido, boquilha e agulha



	<b>WK500010</b> 6 / 001-002.400	<b>WK500020</b> 6 / 001-002.400	<b>WK500030</b> 6 / 001-002.400
	BSP 1"	BSP 1"	BSP 1"
	0.5 MM	0.8 MM	1.0 MM
	8 424835 502515	8 424835 000554	8 424835 000561

## Juego Paso Fluido

### Fluid Nozzle Set

Jogo Passagem Fluido





  
WK500740

**Cuerpo de acero inoxidable**  
**Incluye pico fluido, boquilla y aguja**

Stainless-steel body  
Includes cap, nozzle and needle

Corpo de aço inoxidável  
Inclui bico fluido, boquilha e agulha



	<b>WK500040</b> 6 / 001-002.800	<b>WK500050</b> 6 / 001-002.800	<b>WK500060</b> 6 / 001-002.800
	BSP 1/3"	BSP 1/3"	BSP 1/3"
	1.4 MM	1.7 MM	2.0 MM
	8 424835 000905	8 424835 000516	8 424835 000912

## Juego Paso Fluido

### Fluid Nozzle Set

Jogo Passagem Fluido





  
WK500750

**Cuerpo de acero inoxidable**  
**Incluye pico fluido, boquilla y aguja**

Stainless-steel body  
Includes cap, nozzle and needle

Corpo de aço inoxidável  
Inclui bico fluido, boquilha e agulha



	<b>WK500070</b> 6 / 001-003.000	<b>WK500090</b> 6 / 001-003.000	<b>WK500100</b> 6 / 001-003.000
	BSP 1/3"	BSP 1/3"	BSP 1/3"
	1.4 MM	1.7 MM	2.0 MM
	8 424835 000929	8 424835 002299	8 424835 002244

## Juego Paso Fluido

### Fluid Nozzle Set

Jogo Passagem Fluido





  
WK501100

**Cuerpo de acero inoxidable**  
**Incluye pico fluido, boquilla y aguja**

Stainless-steel body  
Includes cap, nozzle and needle

Corpo de aço inoxidável  
Inclui bico fluido, boquilha e agulha



	<b>WK501130</b> 6 / 001-004.000	<b>WK501140</b> 6 / 001-004.000	<b>WK501150</b> 6 / 001-004.000
	BSP 1"	BSP 1"	BSP 1"
	0.5 MM	0.8 MM	1.0 MM
	8 424835 009489	8 424835 009496	8 424835 009502

## Juego Paso Fluido

### Fluid Nozzle Set

Jogo Passagem Fluido





  
WK501080

**Cuerpo de acero inoxidable**  
**Incluye pico fluido, boquilla y aguja**

Stainless-steel body  
Includes cap, nozzle and needle

Corpo de aço inoxidável  
Inclui bico fluido, boquilha e agulha



	<b>WK501020</b> 6 / 001-004.400	<b>WK501030</b> 6 / 001-004.400	<b>WK501040</b> 6 / 001-004.400
	BSP 1/3"	BSP 1/3"	BSP 1/3"
	1.4 MM	1.7 MM	2.0 MM
	8 424835 009427	8 424835 009434	8 424835 009441

## Juego Paso Fluido

### Fluid Nozzle Set

Jogo Passagem Fluido





  
WK501090

**Cuerpo de acero inoxidable**  
**Incluye pico fluido, boquilla y aguja**

Stainless-steel body  
Includes cap, nozzle and needle

Corpo de aço inoxidável  
Inclui bico fluido, boquilha e agulha



	<b>WK501050</b> 6 / 001-004.600	<b>WK501060</b> 6 / 001-004.600	<b>WK501070</b> 6 / 001-004.600
	BSP 1/3"	BSP 1/3"	BSP 1/3"
	1.4 MM	1.7 MM	2.0 MM
	8 424835 009458	8 424835 009465	8 424835 009472



## Filtro Pistola Pintar Gravedad

### Gravity Paint Spray Gun Filter

Filtro Pistola Pintar Gravidade

**Cuerpo de acero inoxidable y HDPE**

**Compatible con pistolas de pintar de gravedad universales**

Stainless-steel and HDPE body

Compatible with universal gravity paint spray guns

Corpo de aço inoxidável e HDPE

Compatível com pistolas de pintar por gravidade universais



	<b>WK500250</b> 6 / 006-001.800
	36 MM
	11 MM
PCS	10
	8 424835 006464



WK500730  
WK500740  
WK501100  
WK501080  
WK501000  
WK500470  
WK500230

## Depósito Gravedad

### Gravity Cup

Depósito Gravidade

**Cuerpo de HDPE**

**Compatible con pistolas de pintar de gravedad universales**

HDPE body

Compatible with universal gravity paint spray guns

Corpo de HDPE

Compatível com pistolas de pintar por gravidade universais



	<b>WK500170</b> 6 / 001-002.000	<b>WK500180</b> 6 / 001-003.200
	125 ML	600 ML
	BSP 3/8"	BSP 1/2"
	8 424835 003463	8 424835 003470



WK500730  
WK500740  
WK501100  
WK501080  
WK501000  
WK500470  
WK500230



# Pulverizador Cemento-Estuco

## Cement-Stucco Sprayer

Pulverizador Cimento-Estuque

**Cuerpo de aluminio anodizado**

**Acabado cromado y pulido**

**Depósito con asa de aluminio anodizado**

**Mango ergonómico y antideslizante**

**Mango auxiliar de soporte**

**Incluye 4 boquillas integradas**

Anodized aluminum body

Polished chrome finish

Anodized aluminum tank with handle

Ergonomic and non-slip handle

Support auxiliary handle

Includes 4 built-in tips

Corpo de alumínio anodizado

Acabamento cromado e polido











Tanque com alça de alumínio anodizado

Cabo ergonômico e antiderrapante

Cabo auxiliar de suporte

Inclui 4 boquilhas integradas



	<b>WK500920</b> 2 / 001-052.000
	≥ 3 HP / 100 L
	5 - 8 BAR
	8 BAR
	BSP 1/4"
	225 - 375 LPM
	14 MM
	6000 ML
	700 MM
	CE
	8 424835 009021

**Recomendable para trabajos en superficies de hasta 2000 m<sup>2</sup>. Compatible con cementos, masillas, morteros, yesos y estucos.**

**Recommended for works on surfaces up to 2000 m<sup>2</sup>. Compatible with cements, putties, mortars, plasters and stuccos.**

**Recomendado para trabalhos em superfícies de até 2000 m<sup>2</sup>. Compatível com cimentos, massas, argamassas, gessos e estuques.**

# Equipo Eléctrico Airless

## Airless Electric Equipment











### Equipamento Eléctrico Airless

**Cuerpo de ABS composite y aluminio anodizado**  
**Mango ergonómico y antideslizante**  
**Regulador de fluido**  
**Regulador de presión**  
**Fácilmente transportable**  
**Incluye pistola de pintar airless WK500490**  
**Incluye manguera airless de 7.5 metros**  
**Incluye depósito antigoteo extraíble**

Composite ABS and anodized aluminum body  
 Ergonomic and non-slip handle  
 Fluid regulator  
 Pressure regulator  
 Easily transportable  
 Includes airless paint spray gun WK500490  
 Includes 7.5-meter airless hose  
 Includes removable non-drip cup

Corpo de ABS composite e alumínio anodizado  
 Cabo ergonômico e antiderrapante  
 Regulador de fluido  
 Regulador de pressão  
 Facilmente transportável  
 Inclui pistola de pintar airless WK500490  
 Inclui mangueira airless de 7.5 metros  
 Inclui depósito antigotejamento removível



	<b>WK500500</b> 1 / 001-232.000
	0.7 HP / 500 W
	120 - 170 BAR
	205 BAR
	NPS 1/4"
	1.4 LPM
	≤ 0.019"
	5 ≤ 40° C
	CE
	8 424835 008352

**Recomendable para trabajos en superficies de hasta 500 m<sup>2</sup>. Compatible con barnices, lacas, esmaltes, imprimaciones, pinturas de poliuretano, pinturas acrílicas, pinturas plásticas y pinturas de caucho acrílico.**

Recommended for works on surfaces up to 500 m<sup>2</sup>. Compatible with varnishes, lacquers, enamels, primers, polyurethane paints, acrylic paints, plastic paints and acrylic rubber paints.

Recomendado para trabalhos em superfícies de até 500 m<sup>2</sup>. Compatível com vernizes, lacas, esmaltes, primers, tintas de poliuretano, tintas acrílicas, tintas plásticas e tintas de borracha acrílica.



## Equipo Eléctrico Airless

### Airless Electric Equipment

#### Equipamento Eléctrico Airless

**Cuerpo de ABS composite y aluminio anodizado**

**Mango ergonómico y antideslizante**

**Regulador de fluido**

**Regulador de presión**

**Fácilmente transportable**

**Incluye manómetro**

**Incluye pistola de pintar airless WK500600**

**Incluye manguera airless de 15 metros**

**Incluye alargador airless de 500 mm**

**Incluye depósito antigoteo extraíble**

Composite ABS and anodized aluminum body

Ergonomic and non-slip handle

Fluid regulator

Pressure regulator

Easily transportable

Includes manometer

Includes airless paint spray gun WK500600

Includes 15-meter airless hose

Includes 500 mm airless extension bar

Includes removable non-drip cup

Corpo de ABS composite e alumínio anodizado

Cabo ergonômico e antiderrapante

Regulador de fluido

Regulador de pressão

Fácilmente transportável

Inclui manômetro

Inclui pistola de pintar airless WK500600

Inclui mangueira airless de 15 metros

Inclui extensão airless de 500 mm

Inclui depósito antigotejamento removível



	<b>WK500900</b> 1 / 001-432.000
	0.7 HP / 500 W
	120 - 180 BAR
	225 BAR
	NPS 1/4"
	1.8 LPM
	≤ 0.021"
	5 ≤ 40° C
	CE
	8 424835 008475

**Recomendable para trabajos en superficies de hasta 1000 m<sup>2</sup>. Compatible con barnices, lacas, esmaltes, imprimaciones, pinturas de poliuretano, pinturas acrílicas, pinturas plásticas, pinturas de caucho acrílico, pinturas al látex y temple.**

Recommended for works on surfaces up to 1000 m<sup>2</sup>. Compatible with varnishes, lacquers, enamels, primers, polyurethane paints, acrylic paints, plastic paints, acrylic rubber paints, latex paints and temperas.

Recomendado para trabalhos em superfícies de até 1000 m<sup>2</sup>. Compatível com vernizes, lacas, esmaltes, primers, tintas de poliuretano, tintas acrílicas, tintas plásticas, tintas de borracha acrílica, tintas o látex e têmperas.

# Equipo Eléctrico Airless

## Airless Electric Equipment

### Equipamento Eléctrico Airless

**Cuerpo de ABS composite y aluminio anodizado**  
**Mango ergonómico y antideslizante**  
**Regulador de fluido**  
**Regulador de presión con display digital**  
**Fácilmente transportable**  
**Incluye pistola de pintar airless WK500600**  
**Incluye manguera airless de 15 metros**  
**Incluye alargador airless de 500 mm**  
**Incluye depósito antigoteo extraíble**











Composite ABS and anodized aluminum body  
 Ergonomic and non-slip handle  
 Fluid regulator  
 Pressure regulator with digital display  
 Easily transportable  
 Includes airless paint spray gun WK500600  
 Includes 15-meter airless hose  
 Includes 500 mm airless extension bar  
 Includes removable non-drip cup

Corpo de ABS composite e alumínio anodizado  
 Cabo ergonômico e antiderrapante  
 Regulador de fluido  
 Regulador de pressão com display digital  
 Facilmente transportável  
 Inclui pistola de pintar airless WK500600  
 Inclui mangueira airless de 15 metros  
 Inclui extensão airless de 500 mm  
 Inclui depósito antigotejamento removível



**Recomendable para trabajos en superficies de hasta 1500 m<sup>2</sup>. Compatible con barnices, lacas, esmaltes, imprimaciones, pinturas de poliuretano, pinturas acrílicas, pinturas plásticas, pinturas de caucho acrílico, pinturas al látex, temple, revestimientos de techados y pinturas anticorrosivas.**  
 Recommended for works on surfaces up to 1500 m<sup>2</sup>. Compatible with varnishes, lacquers, enamels, primers, polyurethane paints, acrylic paints, plastic paints, acrylic rubber paints, latex paints, temperas, roof coatings and anticorrosive paints.

Recomendado para trabalhos em superfícies de até 1500 m<sup>2</sup>. Compatível com vernizes, lacas, esmaltes, primers, tintas de poliuretano, tintas acrílicas, tintas plásticas, tintas de borracha acrílica, tintas o látex, têmperas, coberturas de telhado e tintas anticorrosivas.

	<b>WK501110</b> 1 / 001-628.000
	2.2 HP / 1600 W
	120 - 180 BAR
	225 BAR
	NPS 1/4"
	3 LPM
	≤ 0.023"
	5 ≤ 40° C
	CE
	8 424835 009342



## Equipo Eléctrico Airless

### Airless Electric Equipment

#### Equipamento Elétrico Airless

Cuerpo de ABS composite y aluminio anodizado

Motor brushless sin escobillas

Ruedas de poliuretano de 200 mm

Asa de transporte plegable

Regulador de fluido

Regulador de presión con display digital

Fácilmente transportable

Incluye pistola de pintar airless WK500600

Incluye manguera airless de 15 metros

Incluye alargador airless de 500 mm

Composite ABS and anodized aluminum body

Brushless motor

Polyurethane wheels of 200 mm

Foldable carry handle

Fluid regulator

Pressure regulator with digital display

Easily transportable

Includes airless paint spray gun WK500600

Includes 15-meter airless hose

Includes 500 mm airless extension bar

Corpo de ABS composite e alumínio anodizado

Motor brushless sem escovas

Rodas de poliuretano de 200 mm

Alça de transporte dobrável

Regulador de fluido

Regulador de pressão com display digital

Facilmente transportável

Inclui pistola de pintar airless WK500600

Inclui mangueira airless de 15 metros

Inclui extensão airless de 500 mm



**Recomendable para trabajos en superficies de hasta 3000 m<sup>2</sup>. Compatible con barnices, lacas, esmaltes, imprimaciones, pinturas de poliuretano, pinturas acrílicas, pinturas plásticas, pinturas de caucho acrílico, pinturas al látex, temple, revestimientos de tejados, pinturas anticorrosivas y películas gruesas.**

*Recommended for works on surfaces up to 3000 m<sup>2</sup>. Compatible with varnishes, lacquers, enamels, primers, polyurethane paints, acrylic paints, plastic paints, acrylic rubber paints, latex paints, temple, roof coatings, anticorrosive paints and thick layers.*

*Recomendado para trabalhos em superfícies de até 3000 m<sup>2</sup>. Compatível com vernizes, lacas, esmaltes, primers, tintas de poliuretano, tintas acrílicas, tintas plásticas, tintas de borracha acrílica, tintas o látex, têmperas, coberturas de telhado, tintas anticorrosivas e películas espesas.*



	<b>WK501120</b> 1 / 001-848.000
	3.8 HP / 2800 W
	120 - 180 BAR
	225 BAR
	NPS 1/4"
	4 LPM
	≤ 0.027"
	5 ≤ 40° C
	CE
	8 424835 009359

# Equipo Eléctrico Airless

## Airless Electric Equipment

### Equipamento Eléctrico Airless

**Cuerpo de ABS composite y aluminio anodizado**

**Motor brushless sin escobillas**

**Ruedas neumáticas de poliuretano de 300 mm**

**Asa de transporte extensible**

**Regulador de fluido**

**Regulador de presión con display digital**

**Fácilmente transportable**

**Incluye pistola de pintar airless WK500600**

**Incluye manguera airless de 30 metros**

**Incluye alargador airless de 1 metro**

Composite ABS and anodized aluminum body

Brushless motor

Pneumatic polyurethane wheels of 300 mm

Extendable carry handle

Fluid regulator

Pressure regulator with digital display

Easily transportable

Includes airless paint spray gun WK500600

Includes 30-meter airless hose

Includes 1-meter airless extension bar

Corpo de ABS composite e alumínio anodizado

Motor brushless sem escovas

Rodas pneumáticas de poliuretano de 300 mm

Alça de transporte extensível

Regulador de fluido

Regulador de pressão com display digital











Facilmente transportável

Inclui pistola de pintar airless WK500600

Inclui mangueira airless de 30 metros

Inclui extensão airless de 1 metro



	<b>WK501200</b> 1 / 001-1980.000
	4 HP / 3000 W
	120 - 180 BAR
	225 BAR
	NPS 1/4"
	5 LPM
	≤ 0.031"
	5 ≤ 40° C
	CE
	8 424835 009816





**Recomendable para trabajos en superficies de hasta 5000 m<sup>2</sup>. Compatible con barnices, lacas, esmaltes, imprimaciones, pinturas de poliuretano, pinturas acrílicas, pinturas plásticas, pinturas de caucho acrílico, pinturas al látex, temple, revestimientos de tejados, pinturas anticorrosivas y películas gruesas.**

*Recommended for works on surfaces up to 5000 m<sup>2</sup>. Compatible with varnishes, lacquers, enamels, primers, polyurethane paints, acrylic paints, plastic paints, acrylic rubber paints, latex paints, temperas, roof coatings, anticorrosive paints and thick layers.*



# Equipo Eléctrico Airless

## Airless Electric Equipment

### Equipamento Eléctrico Airless

**Cuerpo de ABS composite y aluminio anodizado**

**Motor brushless sin escobillas**

**Ruedas neumáticas de poliuretano de 300 mm**

**Asa de transporte extensible**

**Regulador de fluido**

**Regulador de presión con display digital**

**Fácilmente transportable**

**Incluye pistola de pintar airless WK501630**

**Incluye manguera airless de 15 metros**

**Incluye alargador airless de 1 metro**

Composite ABS and anodized aluminum body

Brushless motor

Pneumatic polyurethane wheels of 300 mm

Extendable carry handle

Fluid regulator

Pressure regulator with digital display

Easily transportable

Includes airless paint spray gun WK501630

Includes 15-meter airless hose

Includes 1-meter airless extension bar

Corpo de ABS composite e alumínio anodizado

Motor brushless sem escovas

Rodas pneumáticas de poliuretano de 300 mm

Alça de transporte extensível

Regulador de fluido

Regulador de pressão com display digital











Facilmente transportável

Inclui pistola de pintar airless WK501630

Inclui mangueira airless de 15 metros

Inclui extensão airless de 1 metro



	<b>WK501620</b> 1 / 001-2340.000
	6.7 HP / 5000 W
	120 - 180 BAR
	225 BAR
	NPS 1/4"
	8 LPM
	≤ 0.045"
	5 ≤ 40° C
	CE
	8 424835 011222





**Recomendable para trabajos en superficies de hasta 5000 m<sup>2</sup>. Compatible con barnices, lacas, esmaltes, imprimaciones, pinturas de poliuretano, pinturas acrílicas, pinturas plásticas, pinturas de caucho acrílico, pinturas al látex, temple, revestimientos de tejados, pinturas anticorrosivas, películas gruesas y masillas.**

**Recommended for works on surfaces up to 5000 m<sup>2</sup>. Compatible with varnishes, lacquers, enamels, primers, polyurethane paints, acrylic paints, plastic paints, acrylic rubber paints, latex paints, temperas, roof coatings, anticorrosive paints, thick layers and putties.**

**Recomendado para trabalhos em superfícies de até 5000 m<sup>2</sup>. Compatível com vernizes, lacas, esmaltes, primers, tintas de poliuretano, tintas acrílicas, tintas plásticas, tintas de borracha acrílica, tintas o látex, têmperas, coberturas de telhado, tintas anticorrosivas, películas espesas e massas.**



# Equipo Hidráulico Airless Gasolina

## Gasoline Airless Hydraulic Equipment

### Equipamento Hidráulico Airless Gasolina

**Cuerpo de ABS composite, aluminio anodizado y acero carbono forjado**

**Ruedas neumáticas de caucho de 330 mm**

**Asa de transporte extensible**

**Regulador de presión**

**Motor de gasolina**

**Bomba hidráulica**

**Fácilmente transportable**

**Incluye pistola de pintar airless WK501630**

**Incluye mangueras airless de 3.6 y 15 metros**

Composite ABS, anodized aluminum and forged carbon steel body

Pneumatic rubber wheels of 330 mm

Extendable carry handle

Pressure regulator

Gasoline motor

Hydraulic pump

Easily transportable

Includes airless paint spray gun WK501630

Includes 3.6 and 15-meter airless hoses

Corpo de ABS composite, alumínio anodizado e aço carbono forjado

Rodas pneumáticas de borracha de 330 mm

Alça de transporte extensível

Regulador de pressão

Motor de gasolina











Bomba hidráulica

Facilmente transportável

Inclui pistola de pintar airless WK501630

Inclui mangueiras airless de 3.6 e 15 metros



	<b>WK501400</b> 1 / 001-2620.000
	9 HP / 6700 W
	120 - 180 BAR
	225 BAR
	NPS 1/2"
	12 LPM
	≤ 0.057"
	5 ≤ 40° C
	CE
	8 424835 010102



**Recomendable para trabajos en superficies de más de 5000 m<sup>2</sup>. Compatible con barnices, lacas, esmaltes, imprimaciones, pinturas de poliuretano, pinturas acrílicas, pinturas plásticas, pinturas de caucho acrílico, pinturas al látex, temple, revestimientos de tejados, pinturas anticorrosivas, películas gruesas y masillas.**

*Recommended for works on surfaces of more than 5000 m<sup>2</sup>. Compatible with varnishes, lacquers, enamels, primers, polyurethane paints, acrylic paints, plastic paints, acrylic rubber paints, latex paints, temperas, roof coatings, anticorrosive paints, thick layers and putties.*

*Recomendado para trabalhos em superfícies de mais de 5000 m<sup>2</sup>. Compatível com vernizes, lacas, esmaltes, primers, tintas de poliuretano, tintas acrílicas, tintas plásticas, tintas de borracha acrílica, tintas o látex, têmperas, coberturas de telhado, tintas anticorrosivas, películas espesas e massas.*



# Pistola Pintar Airless

## Airless Paint Spray Gun

Pistola Pintar Airless

**Cuerpo de aluminio anodizado**

**Acabado cromado, pulido y electroforético**

**Gatillo con función de bloqueo de seguridad**

**Mango ergonómico y antideslizante**

**Mango con protector de puño**

**Racor giratorio para conexión con manguera**

**Compatible con Graco, Wagner, Titan y otras marcas**

**Incluye portaboquillas airless**

**Incluye boquilla airless 517**

**Incluye filtro de malla airless de 100 micras**

Anodized aluminum body

Chrome, polished and electrophoretic finish

Trigger with safety lock function

Ergonomic and non-slip handle

Fist protector handle

Swivel fitting for hose connection

Compatible with Graco, Wagner, Titan and other brands

Includes airless tip holder

Includes 517 airless tip

Includes 100 micron airless mesh filter

Corpo de alumínio anodizado

Acabamento cromado, polido e eletroforético

Gatilho com função de bloqueio de segurança

Cabo ergonômico e antiderrapante

Cabo com protector de punho

União giratória para conexão de mangueira









Compatível com Graco, Wagner, Titan e outras marcas

Inclui porta-boquilhas airless

Inclui boquilha airless 517

Inclui filtro de malha airless de 100 microns



	<b>WK500490</b> 20 / 001-026.000
	≥ 0.5 HP / 375 W
	60 - 160 BAR
	250 BAR
	NPS 1/4"
	BSP 7/8"
	5 ≤ 40° C
	CE
	8 424835 008345

**Compatible con barnices, lacas, esmaltes, imprimaciones, pinturas de poliuretano, pinturas acrílicas, pinturas plásticas y pinturas de caucho acrílico.**

Compatible with varnishes, lacquers, enamels, primers, polyurethane paints, acrylic paints, plastic paints and acrylic rubber paints.

Compatível com vernizes, lacas, esmaltes, primers, tintas de poliuretano, tintas acrílicas, tintas plásticas e tintas de borracha acrílica.

# Pistola Pintar Airless

## Airless Paint Spray Gun

### Pistola Pintar Airless

**Cuerpo de aluminio anodizado**

**Acabado cromado y pulido**

**Gatillo con función de bloqueo de seguridad**

**Mango ergonómico y antideslizante**

**Mango con protector de puño**

**Racor giratorio para conexión con manguera**

**Compatible con Graco, Wagner, Titan y otras marcas**

**Incluye portaboquillas airless**

**Incluye boquilla airless 517**

**Incluye filtro de malla airless de 100 micras**

Anodized aluminum body

Chrome and polished finish

Trigger with safety lock function

Ergonomic and non-slip handle

Fist protector handle

Swivel fitting for hose connection

Compatible with Graco, Wagner, Titan and other brands

Includes airless tip holder

Includes 517 airless tip

Includes 100 micron airless mesh filter

Corpo de alumínio anodizado

Acabamento cromado e polido

Gatilho com função de bloqueio de segurança

Cabo ergonômico e antiderrapante

Cabo com protetor de punho

União giratória para conexão de mangueira

Compatível com Graco, Wagner, Titan e outras marcas

Inclui porta-boquilhas airless

Inclui boquilha airless 517

Inclui filtro de malha airless de 100 microns



**Compatible con barnices, lacas, esmaltes, imprimaciones, pinturas de poliuretano, pinturas acrílicas, pinturas plásticas, pinturas de caucho acrílico, pinturas al látex, temples, revestimientos de tejados, pinturas anticorrosivas y películas gruesas.**

Compatible with varnishes, lacquers, enamels, primers, polyurethane paints, acrylic paints, plastic paints, acrylic rubber paints, latex paints, temperas, roof coatings, anticorrosive paints and thick layers.

Compatível com vernizes, lacas, esmaltes, primers, tintas de poliuretano, tintas acrílicas, tintas plásticas, tintas de borracha acrílica, tintas o látex, têmperas, coberturas de telhado, tintas anticorrosivas e películas espesas.

	<b>WK500600</b> 20 / 001-042.000
	≥ 0.5 HP / 375 W
	60 - 160 BAR
	250 BAR
	NPS 1/4"
	BSP 7/8"
	5 ≤ 40° C
	CE
	8 424835 008338



# Pistola Pintar Airless

## Airless Paint Spray Gun

Pistola Pintar Airless

**Cuerpo de aluminio anodizado**

**Acabado cromado, pulido y electroforético**

**Gatillo con función de bloqueo de seguridad**

**Mango ergonómico y antideslizante**

**Mango con protector de puño**

**Racor giratorio para conexión con manguera**

**Compatible con Graco, Wagner, Titan y otras marcas**

**Incluye portaboquillas airless**

**Incluye boquilla airless 517**

**Incluye filtro de malla airless de 100 micras**

Anodized aluminum body

Chrome, polished and electrophoretic finish

Trigger with safety lock function

Ergonomic and non-slip handle

Fist protector handle

Swivel fitting for hose connection

Compatible with Graco, Wagner, Titan and other brands

Includes airless tip holder

Includes 517 airless tip

Includes 100 micron airless mesh filter

Corpo de alumínio anodizado

Acabamento cromado, polido e eletroforético

Gatilho com função de bloqueio de segurança

Cabo ergonômico e antiderrapante

Cabo com protector de punho

União giratória para conexão de mangueira

Compatível com Graco, Wagner, Titan e outras marcas

Inclui porta-boquilhas airless

Inclui boquilha airless 517

Inclui filtro de malha airless de 100 microns











**Compatible con barnices, lacas, esmaltes, imprimaciones, pinturas de poliuretano, pinturas acrílicas, pinturas plásticas, pinturas de caucho acrílico, pinturas al látex, temples, revestimientos de tejados, pinturas anticorrosivas, películas gruesas y masillas.**

Compatible with varnishes, lacquers, enamels, primers, polyurethane paints, acrylic paints, plastic paints, acrylic rubber paints, latex paints, temperas, roof coatings, anticorrosive paints, thick layers and putties.

Compatível com vernizes, lacas, esmaltes, primers, tintas de poliuretano, tintas acrílicas, tintas plásticas, tintas de borracha acrílica, tintas o látex, têmperas, coberturas de telhado, tintas anticorrosivas, películas espesas e massas.



	<b>WK501360</b> 20 / 001-052.000
	≥ 1 HP / 750 W
	60 - 210 BAR
	310 BAR
	NPS 1/4"
	BSP 7/8"
	5 ≤ 40° C
	CE
	8 424835 010119

## Pistola Pintar Airless In-Line

### In-Line Airless Paint Spray Gun

Pistola Pintar Airless In-Line

**Cuerpo de aluminio anodizado**

**Acabado cromado y pulido**

**Gatillo con función de bloqueo de seguridad**

**Mango ergonómico y antideslizante**

**Mango con protector de puño**

**Racor giratorio para conexión con manguera**

**Compatible con Graco, Wagner, Titan y otras marcas**

**Incluye portaboquillas airless**

**Incluye boquilla airless 517**

**Incluye filtro de malla airless de 100 micras**

Anodized aluminum body

Chrome and polished finish

Trigger with safety lock function

Ergonomic and non-slip handle

Fist protector handle

Swivel fitting for hose connection

Compatible with Graco, Wagner, Titan and other brands

Includes airless tip holder

Includes 517 airless tip

Includes 100 micron airless mesh filter

Corpo de alumínio anodizado

Acabamento cromado e polido

Gatilho com função de bloqueio de segurança

Cabo ergonômico e antiderrapante

Cabo com protector de punho

União giratória para conexão de mangueira

Compatível com Graco, Wagner, Titan e outras marcas

Inclui porta-boquilhas airless

Inclui boquilha airless 517









Inclui filtro de malha airless de 100 microns



**Compatible con barnices, lacas, esmaltes, imprimaciones, pinturas de poliuretano, pinturas acrílicas, pinturas plásticas, pinturas de caucho acrílico, pinturas al látex, templets, revestimientos de tejados, pinturas anticorrosivas y películas gruesas.**

Compatible with varnishes, lacquers, enamels, primers, polyurethane paints, acrylic paints, plastic paints, acrylic rubber paints, latex paints, temperas, roof coatings, anticorrosive paints and thick layers.

Compatível com vernizes, lacas, esmaltes, primers, tintas de poliuretano, tintas acrílicas, tintas plásticas, tintas de borracha acrílica, tintas o látex, têmperas, coberturas de telhado, tintas anticorrosivas e películas espesas.

	<b>WK501500</b> 20 / 001-050.000
	≥ 0.5 HP / 375 W
	60 - 160 BAR
	250 BAR
	NPS 1/4"
	BSP 7/8"
	5 ≤ 40° C
	CE
	8 424835 010584



# Pistola Pintar Airless Aire-Asistido

## Air-Assisted Airless Paint Spray Gun

Pistola Pintar Airless Ar-Assistido

**Cuerpo de aluminio anodizado**

**Acabado cromado y pulido**

**Gatillo con función de bloqueo de seguridad**

**Mango ergonómico y antideslizante**

**Mango con protector de puño**

**Racor giratorio para conexión con manguera**

**Compatible con Graco, Wagner, Titan y otras marcas**

**Incluye portaboquillas airless**

**Incluye boquilla airless 517**

**Incluye filtro de malla airless de 100 micras**

Anodized aluminum body

Chrome and polished finish

Trigger with safety lock function

Ergonomic and non-slip handle

Fist protector handle

Swivel fitting for hose connection

Compatible with Graco, Wagner, Titan and other brands

Includes airless tip holder

Includes 517 airless tip

Includes 100 micron airless mesh filter

Corpo de alumínio anodizado

Acabamento cromado e polido

Gatilho com função de bloqueio de segurança

Cabo ergonômico e antiderrapante

Cabo com protector de punho

União giratória para conexão de mangueira

Compatível com Graco, Wagner, Titan e outras marcas

Inclui porta-boquilhas

Inclui boquilha airless 517









Inclui filtro de malha airless de 100 microns



**Compatible con barnices, lacas, esmaltes, imprimaciones, pinturas de poliuretano, pinturas acrílicas, pinturas plásticas, pinturas de caucho acrílico, pinturas al látex, templets, revestimientos de tejados, pinturas anticorrosivas y películas gruesas.**

Compatible with varnishes, lacquers, enamels, primers, polyurethane paints, acrylic paints, plastic paints, acrylic rubber paints, latex paints, temperas, roof coatings, anticorrosive paints and thick layers.

Compatível com vernizes, lacas, esmaltes, primers, tintas de poliuretano, tintas acrílicas, tintas plásticas, tintas de borracha acrílica, tintas o látex, têmperas, coberturas de telhado, tintas anticorrosivas e películas espesas.

	<b>WK501540</b> 20 / 001-074.000
	≥ 0.5 HP / 375 W
	80 - 160 BAR
	230 BAR
	NPS 1/4"
	BSP 7/8"
	5 ≤ 40° C
	CE
	8 424835 010591



# Pistola Pintar Airless Alta Presión High Pressure Airless Paint Spray gun

Pistola Pintar Airless Alta Pressão

**Cuerpo de aluminio anodizado**

**Acabado cromado, pulido y electroforético**

**Gatillo con función de bloqueo de seguridad**

**Mango ergonómico y antideslizante**

**Mango con protector de puño**

**Racor giratorio para conexión con manguera**

**Compatible con Graco, Wagner, Titan y otras marcas**

**Incluye portaboquillas airless**

**Incluye boquilla airless 517**

Anodized aluminum body

Chrome, polished and electrophoretic finish

Trigger with safety lock function

Ergonomic and non-slip handle

Fist protector handle

Swivel fitting for hose connection

Compatible with Graco, Wagner, Titan and other brands

Includes airless tip holder

Includes airless 517 tip

Corpo de alumínio anodizado

Acabamento cromado, polido e eletroforético

Gatilho com função de bloqueio de segurança

Cabo ergonômico e antiderrapante

Cabo com protector de punho

União giratória para conexão de mangueira

Compatível com Graco, Wagner, Titan e outras marcas

Inclui porta-boquilhas airless

Inclui boquilha airless 517



**Compatible con barnices, lacas, esmaltes, imprimaciones, pinturas de poliuretano, pinturas acrílicas, pinturas plásticas, pinturas de caucho acrílico, pinturas al látex, temples, revestimientos de tejados, pinturas anticorrosivas, películas gruesas y masillas.**

Compatible with varnishes, lacquers, enamels, primers, polyurethane paints, acrylic paints, plastic paints, acrylic rubber paints, latex paints, temperas, roof coatings, anticorrosive paints, thick layers and putties.

Compatível com vernizes, lacas, esmaltes, primers, tintas de poliuretano, tintas acrílicas, tintas plásticas, tintas de borracha acrílica, tintas o látex, têmperas, coberturas de telhado, tintas anticorrosivas, películas espesas e massas.



	<b>WK501630</b> 20 / 001-084.000
	≥ 1 HP / 750 W
	80 - 350 BAR
	500 BAR
	NPS 1/4"
	BSP 7/8"
	5 ≤ 40° C
	CE
	8 424835 011239

# Boquilla Airless

## Airless Tip

Boquilha Airless

**Cuerpo de carburo tungsteno**

**Compatible con RAC-5 de Graco**

**Compatible con rociados de viscosidad baja y media**

**Incluye junta de sellado de boquilla**

Tungsten carbide body

Compatible with RAC-5 from Graco

Compatible with low and medium viscosity pulverization



Includes tip seal gasket



Corpo de carburado tungstênio



Compatível com RAC-5 de Graco



Compatível com pulverização de baixa e média viscosidade



Inclui junta de selado de boquilha



	<b>WK501170</b> 6 / 001-008.200	<b>WK500930</b> 6 / 001-008.200	<b>WK501550</b> 6 / 001-008.200
	211	213	215
	8 424835 009786	8 424835 009281	8 424835 010799

	<b>WK501560</b> 6 / 001-008.200	<b>WK500880</b> 6 / 001-008.200	<b>WK500890</b> 6 / 001-008.200	<b>WK500940</b> 6 / 001-008.200
	311	313	315	317
	8 424835 010805	8 424835 008536	8 424835 008543	8 424835 009298

	<b>WK501570</b> 6 / 001-008.200	<b>WK501370</b> 6 / 001-008.200	<b>WK500540</b> 6 / 001-008.200	<b>WK500550</b> 6 / 001-008.200	<b>WK500560</b> 6 / 001-008.200	<b>WK500570</b> 6 / 001-008.200
	411	413	415	417	419	421
	8 424835 010812	8 424835 010126	8 424835 008437	8 424835 008444	8 424835 008451	8 424835 008468

	<b>WK501380</b> 6 / 001-008.200	<b>WK500630</b> 6 / 001-008.200	<b>WK500640</b> 6 / 001-008.200	<b>WK500650</b> 6 / 001-008.200	<b>WK500860</b> 6 / 001-008.200	
		513	515	517	519	521
		8 424835 010133	8 424835 008505	8 424835 008512	8 424835 008529	8 424835 008482

	<b>WK501390</b> 6 / 001-008.200	<b>WK501180</b> 6 / 001-008.200	<b>WK501190</b> 6 / 001-008.200	<b>WK501210</b> 6 / 001-008.200	<b>WK501220</b> 6 / 001-008.200	
		613	615	617	619	621
		8 424835 010140	8 424835 009793	8 424835 009809	8 424835 009823	8 424835 009830



**WK500490**  
**WK500600**  
**WK501360**  
**WK501500**  
**WK501540**  
**WK501630**



<b>WK500950</b> 6 / 001-008.200	<b>WK500960</b> 6 / 001-008.200	<b>WK501410</b> 6 / 001-008.200	<b>WK501440</b> 6 / 001-008.200
423	425	427	429
8 424835 009304	8 424835 009311	8 424835 010157	8 424835 010188

<b>WK500970</b> 6 / 001-008.200	<b>WK500980</b> 6 / 001-008.200	<b>WK501420</b> 6 / 001-008.200	<b>WK501450</b> 6 / 001-008.200
523	525	527	529
8 424835 009328	8 424835 009335	8 424835 010164	8 424835 010195

<b>WK501230</b> 6 / 001-008.200	<b>WK501240</b> 6 / 001-008.200	<b>WK501430</b> 6 / 001-008.200	<b>WK501460</b> 6 / 001-008.200
623	625	627	629
8 424835 009847	8 424835 009854	8 424835 010171	8 424835 010201

<b>WK501250</b> 6 / 001-008.200	<b>WK501260</b> 6 / 001-008.200
723	725
8 424835 009861	8 424835 009878

**El primer número indica el ángulo. Por ejemplo, 5 corresponde a 50°. Para obtener el ancho del abanico, multiplique el número del ángulo por 5. Por ejemplo, 5x5=25 cm. Los segundos dos números indican el flujo de pintura. Por ejemplo, 17 corresponde a un diámetro de 0.017".**

The first number indicates the angle. For example, 5 corresponds to 50°. To obtain the fan width, multiply the angle number by 5. In this case, 5x5=25 cm. The second two numbers indicate the paint flow. For example, 17 corresponds to a diameter of 0.017".

O primeiro número indica o ângulo. Por exemplo, 5 corresponde a 50°. Para obter a largura do leque, multiplique o número do ângulo por 5. Neste caso, 5x5=25 cm. Os segundos dois números indicam o fluxo de tinta. Por exemplo, 17 corresponde a um diâmetro de 0.017".



# Boquilla Airless

## Airless Tip

### Boquilha Airless



WK501360  
WK501630

**Cuerpo de carburo tungsteno**

**Compatible con RAC-XHD de Graco**

**Compatible con rociados de viscosidad alta**

**Incluye junta de sellado de boquilla**

Tungsten carbide body

Compatible with RAC-XHD from Graco

Compatible with high viscosity pulverization

Includes tip seal gasket

Corpo de carburado tungstênio

Compatível com RAC-XHD de Graco

Compatível com pulverização de alta viscosidade

Inclui junta de selado de boquilha



**El primer número indica el ángulo. Por ejemplo, 5 corresponde a 50°. Para obtener el ancho del abanico, multiplique el número del ángulo por 5. Por ejemplo, 5x5=25 cm. Los segundos dos números indican el flujo de pintura. Por ejemplo, 17 corresponde a un diámetro de 0.017".**

The first number indicates the angle. For example, 5 corresponds to 50°. To obtain the fan width, multiply the angle number by 5. In this case, 5x5=25 cm. The second two numbers indicate the paint flow. For example, 17 corresponds to a diameter of 0.017".

O primeiro número indica o ângulo. Por exemplo, 5 corresponde a 50°. Para obter a largura do leque, multiplique o número do ângulo por 5. Neste caso, 5x5=25 cm. Os segundos dois números indicam o fluxo de tinta. Por exemplo, 17 corresponde a um diâmetro de 0.017".



	<b>WK501470</b> 6 / 001-009.200	<b>WK501480</b> 6 / 001-009.200
	535	539
	8 424835 010218	8 424835 010225

	<b>WK501490</b> 6 / 001-009.200	<b>WK501510</b> 6 / 001-009.200	<b>WK501520</b> 6 / 001-009.200	<b>WK501530</b> 6 / 001-009.200
	635	639	643	647
	8 424835 010232	8 424835 010249	8 424835 010256	8 424835 010263

## Filtro Malla Airless

### Airless Mesh Filter

Filtro Malha Airless

**Cuerpo de acero inoxidable y HDPE**

**Compatible con Graco, Wagner, Titan y otras marcas**

Stainless-steel and HDPE body

Compatible with Graco, Wagner, Titan and other brands

Corpo de aço inoxidável e HDPE

Compatível com Graco, Wagner, Titan e outras marcas



WK500490

WK500600

WK501360

WK501500

WK501540

Ø L	<b>WK501310</b> 6 / 006-001.600	<b>WK501320</b> 6 / 006-001.600
	#60	#100
↑ ↓	110-130 MM	110-130 MM
Ø	10 MM	10 MM
PCS	2	2
	8 424835 009922	8 424835 009939

## Filtro Malla Airless

### Airless Mesh Filter

Filtro Malha Airless

**Cuerpo de acero inoxidable y HDPE**

**Compatible con Graco, Wagner, Titan y otras marcas**

Stainless-steel and HDPE body

Compatible with Graco, Wagner, Titan and other brands

Corpo de aço inoxidável e HDPE

Compatível com Graco, Wagner, Titan e outras marcas



WK500490

WK500600

WK501360

WK501500

WK501540

Ø L	<b>WK501270</b> 6 / 006-001.600	<b>WK501280</b> 6 / 006-001.600	<b>WK501290</b> 6 / 006-001.600	<b>WK501300</b> 6 / 006-001.600
	#50	#80	#100	#150
↑ ↓	102 MM	102 MM	102 MM	102 MM
Ø	10 MM	10 MM	10 MM	10 MM
PCS	2	2	2	2
	8 424835 009885	8 424835 009892	8 424835 009908	8 424835 009915

## Portaboquillas Airless

### Airless Tip Holder

Porta-Boquilhas Airless

**Cuerpo de acero inoxidable y HDPE**

**Acabado cromado y pulido**

**Compatible con Graco, Wagner, Titan y otras marcas**

Stainless-steel and HDPE body

Chrome and polished finish

Compatible with Graco, Wagner, Titan and other brands

Corpo de aço inoxidável e HDPE

Acabamento cromado e polido

Compatível com Graco, Wagner, Titan e outras marcas



	<b>WK500460</b> 6 / 001-006.000
	BSP 7/8"
	250 BAR
	-5 ≤ 65° C
	8 424835 008406

## Junta Sellado Boquilla Airless

### Airless Tip Seal Gasket

Junta Selado Boquilha Airless

**Cuerpo de acero tungsteno y teflón PTFE**

**Compatible con Graco**

Tungsten steel and PTFE teflon body

Compatible with Graco

Corpo de aço tungstênio e teflon PTFE

Compatível com Graco



	<b>WK501350</b> 12 / 001-005.600
	3 MM
PCS	5
	8 424835 010270



## Portaboquillas Giratorio Airless

### Airless Swivel Tip Holder

Porta-Boquilhas Giratório Airless

**Cuerpo de acero inoxidable y HDPE**

**Acabado cromado, pulido y electroforético**

**Compatible con Graco, Wagner, Titan y otras marcas**

**Incluye portaboquillas WK500460**

**Incluye boquilla 517**

Stainless-steel and HDPE body

Chrome, polished and electrophoretic finish

Compatible with Graco, Wagner, Titan and other brands

Includes WK500460 tip holder

Includes 517 tip

Corpo de aço inoxidável e HDPE







Acabamento cromado, polido e eletroforético

Compatível com Graco, Wagner, Titan e outras marcas

Inclui porta-boquilhas WK500460

Inclui boquilha 517



	<b>WK500870</b> 6 / 001-018.000
	BSP 7/8"
	250 BAR
	-5 ≤ 65° C
	0-180°
	8 424835 008499

## Portaboquillas Giratorio Guía Bordes Airless

### Airless Edge Guide Swivel Tip Holder

Porta-Boquilhas Giratório Guia Bordas Airless

**Cuerpo de acero inoxidable y HDPE**

**Acabado cromado, pulido y electroforético**

**Compatible con Graco, Wagner, Titan y otras marcas**

**Incluye portaboquillas WK500460**

**Incluye boquilla 517**

Stainless-steel and HDPE body

Chrome, polished and electrophoretic finish

Compatible with Graco, Wagner, Titan and other brands

Includes WK500460 tip holder

Includes 517 tip

Corpo de aço inoxidável e HDPE







Acabamento cromado, polido e eletroforético

Compatível com Graco, Wagner, Titan e outras marcas

Inclui porta-boquilhas WK500460

Inclui boquilha 517



	<b>WK501580</b> 60 / 001-023.000
	BSP 7/8"
	250 BAR
	-5 ≤ 65° C
	0-180°
	130 MM
	8 424835 010829



# Alargador Airless

## Airless Extension Bar

Alargador Airless

**Cuerpo de aluminio anodizado**

**Acabado cromado y pulido**

**Conexiones de rosca hembra y macho**

**Incluye protectores de rosca**

**Compatible con Graco, Wagner, Titan y otras marcas**

**Incluye protectores de rosca**

Anodized aluminum body

Chrome and polished finish

Female and male threaded connections

Includes thread protectors

Compatible with Graco, Wagner, Titan and other brands

Includes thread protectors

Corpo de alumínio anodizado

Acabamento cromado e polido







Conexões roscadas fêmea e macho

Inclui protetores de rosca

Compatível com Graco, Wagner, Titan e outras marcas

Inclui protetores de rosca



	<b>WK500510</b>	<b>WK500520</b>	<b>WK501330</b>	<b>WK501340</b>
	5 / 001-004.400	5 / 001-005.400	5 / 001-007.400	5 / 001-011.400
	300 MM	600 MM	1000 MM	1800 MM
	5 X 12 MM	5 X 12 MM	5 X 12 MM	5 X 12 MM
	BSP 7/8"	BSP 7/8"	BSP 7/8"	BSP 7/8"
	280 BAR	280 BAR	280 BAR	280 BAR
	-5 ≤ 65° C	-5 ≤ 65° C	-5 ≤ 65° C	-5 ≤ 65° C
	8 424835 008314	8 424835 008321	8 424835 009571	8 424835 009588





# Manguera Airless

## Airless Hose

### Mangueira Airless

**Cuerpo de caucho y fibra de vidrio**

**Conexiones de rosca hembra**

**Ligera y flexible**

**Extremos con protección de muelles galvanizados**

**Compatible con Graco, Wagner, Titan y otras marcas**

Rubber and fibreglass body

Female thread connections

Light and flexible

Galvanized spring protection ends

Compatible with Graco, Wagner, Titan and other brands

Corpo de borracha e fibra de vidro

Conexões de rosca fêmea

Leve e flexível

Extremos com proteção de molas galvanizadas

Compatível com Graco, Wagner, Titan e outras marcas



	<b>WK500610</b> 5 / 001-018.000	<b>WK500620</b> 3 / 001-028.000
	7.5 M	15 M
	6 X 13 MM	6 X 13 MM
	NPS 1/4"	NPS 1/4"
	225 BAR	225 BAR
	-5 ≤ 65° C	-5 ≤ 65° C
	8 424835 008413	8 424835 008420

# Pistola Espuma Poliuretano

## Polyurethane Foam Gun

Pistola Espuma Poliuretano

**Cuerpo de aluminio anodizado y latón**

**Cuerpo interior y exterior recubierto de teflón PTFE antiadherente**

**Mango de caucho**

**Mango ergonómico y antideslizante**

**Regulador de fluido interior para uso con una sola mano**

**Válvula con bola interior de no retorno de PVC**

**Compatible con cartuchos universales**

Anodized aluminum and brass body

Inner and outer body coated in non-stick PTFE teflon

Rubber handle

Ergonomic and non-slip handle

Interior fluid regulator for one handed use

Valve with PVC non-return inner ball

Compatible with universal cartridges

Corpo de alumínio anodizado e latão

Corpo interno e externo revestido de teflon PTFE antiaderente

Punho de borracha

Cabo ergonômico e antiderrapante

Regulador de fluido interior para uso com uma única mão

Válvula com bola anti-retorno de PVC

Compatível com cartuchos universais



**El revestimiento de teflón PTFE antiadherente proporciona una excelente protección contra el secado y pegado de la espuma de poliuretano, lo cual facilita su limpieza y alarga la vida útil.**

The non-stick PTFE teflon coating provides an excellent protection against drying and sticking of the polyurethane foam, which makes its cleaning easier and extends the useful life.

O revestimento de teflon PTFE antiaderente oferece uma excelente proteção contra o ressecamento e aderência da espuma de poliuretano, o que facilita sua limpeza e prolonga a vida útil.



	<b>WK501160</b> 20 / 001-009.600
	6 - 7 BAR
	14 BAR
	190 MM
	8 424835 009694

# Pistola Espuma Poliuretano

## Polyurethane Foam Gun

### Pistola Espuma Poliuretano

**Cuerpo de aluminio anodizado y latón**

**Cuerpo interior y exterior doblemente recubierto de teflón PTFE antiadherente**

**Mango de caucho**

**Mango ergonómico y antideslizante**

**Regulador de fluido interior para uso con una sola mano**

**Válvula con bola interior de no retorno de teflón PTFE antiadherente**

**Compatible con cartuchos universales**

Anodized aluminum and brass body

Inner and outer body doubly coated in non-stick PTFE teflon

Rubber handle

Ergonomic and non-slip handle

Interior fluid regulator for one handed use

Valve with non-stick PTFE teflon non-return inner ball

Compatible with universal cartridges

Corpo de alumínio anodizado e latão

Corpo interno e externo duplamente revestido de teflon PTFE antiaderente

Punho de borracha

Cabo ergonômico e antiderrapante

Regulador de fluido interior para uso com uma única mão

Válvula com bola anti-retorno de teflon PTFE antiaderente

Compatível com cartuchos universais



**El doble revestimiento de teflón PTFE antiadherente proporciona una excelente protección contra el secado y pegado de la espuma de poliuretano, lo cual facilita su limpieza y alarga la vida útil.**

The non-stick PTFE teflon double coating provides an excellent protection against drying and sticking of the polyurethane foam, which makes its cleaning easier and extends the useful life.

O dobro revestimento de teflon PTFE antiaderente oferece uma excelente proteção contra o ressecamento e aderência da espuma de poliuretano, o que facilita sua limpeza e prolonga a vida útil.

	<b>WK501590</b> 20 / 001-014.600
	6 - 7 BAR
	14 BAR
	190 MM
	8 424835 010836



# Lijadora Circular Rotorbital

## Rotorbital Circular Sander

### Lixadora Circular Rotorbital

**Cuerpo de ABS composite**

**Mango ergonómico y antideslizante**

**Función de giro rotorbital**

**Fijación del disco con velcro**

**Regulador de presión con válvula integrada de corte de aire**

**Incluye disco microperforado de lijado de 75 mm**

Composite ABS body

Ergonomic and non-slip handle

Rotorbital spin function

Velcro disc fixing

Pressure regulator with integrated air cut valve

Includes 75 mm microperforated sanding disc

Corpo de ABS composite

Cabo ergonômico e antiderrapante











Função de rotação rotorbital

Fixação do disco com velcro

Regulador de pressão com válvula integrada de corte de ar

Inclui disco microperforado de lixado de 75 mm



	<b>WK501610</b> 18 / 001-028.000
	≥ 2 HP / 100 L
	4-5 BAR
	6 BAR
	BSP 1/4"
	100 LPM
	12000 RPM
	75 MM
	5 MM
	CE
	8 424835 010850



# Lijadora Circular Rotorbital

## Rotorbital Circular Sander

### Lixadora Circular Rotorbital

**Cuerpo de ABS composite**

**Sistema de auto-extracción integrado compatible con colector de polvo o aspirador**

**Mango ergonómico y antideslizante**

**Función de giro rotorbital**

**Fijación del disco con velcro**

**Regulador de presión con válvula integrada de corte de aire**

**Incluye disco microperforado de lijado de 150 mm**

**Incluye colector de polvo de 500 ml**

Composite ABS body

Integrated auto-extraction system compatible with dust collector or vacuum cleaner

Ergonomic and non-slip handle

Rotorbital spin function

Velcro disc fixing

Pressure regulator with integrated air cut valve

Includes 150 mm microperforated sanding disc

Includes 500 ml dust collector

Corpo de ABS composite

Sistema de auto-extração integrado compatível com coletor de pó ou aspirador

Cabo ergonômico e antiderrapante

Função de rotação rotorbital











Fixação do disco com velcro

Regulador de pressão com válvula integrada de corte de ar

Inclui disco microperforado de lixado de 150 mm

Inclui coletor de pó de 500 ml



	<b>WK501600</b> 12 / 001-032.000	<b>WK500290</b> 12 / 001-032.000
	≥ 2 HP / 100 L	≥ 2 HP / 100 L
	4-5 BAR	4-5 BAR
	6 BAR	6 BAR
	BSP 1/4"	BSP 1/4"
	100 LPM	100 LPM
	10500 RPM	10500 RPM
	150 MM	150 MM
	2.5 MM	5 MM
	CE	CE
	8 424835 010843	8 424835 001940



## Filtro Aire

### Air Filter





Filtro Ar

**Cuerpo de aluminio anodizado y policarbonato**

Anodized aluminum and polycarbonate body

Corpo de alumínio anodizado e policarbonato



	<b>WK500320</b> 10 / 001-003.200
	BSP 1/4"
	≤ 1000 LPM
	10 BAR
	8 424835 007089

## Lubricador Aire

### Air Lubricator





Lubrificador Ar

**Cuerpo de latón y policarbonato**

Brass and polycarbonate body

Corpo de latão e policarbonato



	<b>WK500330</b> 10 / 001-002.200
	BSP 1/4"
	≤ 1000 LPM
	10 BAR
	8 424835 007096

## Regulador Aire

### Air Regulator

Regulador Ar

**Cuerpo de aluminio anodizado y ABS composite**

**Medición en BAR y PSI**







Anodized aluminum and composite ABS body

BAR and PSI measure

Corpo de alumínio anodizado e ABS composite

Medição em BAR e PSI



	<b>WK500340</b> 10 / 001-005.800
	BSP 1/4"
	≤ 1000 LPM
	0-10 BAR
	12 BAR
	8 424835 007102

## Filtro-Regulador Aire

### Air Filter-Regulator

#### Filtro-Regulador Ar

**Cuerpo de policarbonato**  
**Medición en BAR y PSI**

Polycarbonate body  
BAR and PSI measure

Corpo de policarbonato  
Medição em BAR e PSI



	<b>WK500300</b> 05 / 001-010.000
	BSP 1/2"
	≤ 1500 LPM
	0-10 BAR
	12 BAR
	10 MIC
	5-60° C
	125 ML
	8 424835 007065

## Filtro-Regulador-Lubricador Aire

### Air Filter-Regulator-Lubricator

#### Filtro-Regulador-Lubrificador Ar

**Cuerpo de policarbonato**  
**Medición en BAR y PSI**

Polycarbonate body  
BAR and PSI measure

Corpo de policarbonato  
Medição em BAR e PSI



	<b>WK500310</b> 05 / 001-016.000
	BSP 1/2"
	≤ 1500 LPM
	0-10 BAR
	12 BAR
	10 MIC
	5-60° C
	125 / 125 ML
	8 424835 007072

**Enchufe rápido**  
**Quick coupler**  
 Plugue rápido

**Cuerpo de acero inoxidable**  
**Conexión de rosca hembra**

Stainless-steel body  
 Female thread connection

Corpo de aço inoxidável  
 Conexão de rosca fêmea



**Enchufe rápido**  
**Quick coupler**  
 Plugue rápido

**Cuerpo de acero inoxidable**  
**Conexión de rosca macho**

Stainless-steel body  
 Male thread connection

Corpo de aço inoxidável  
 Conexão de rosca macho



	<b>WK500380</b> 20 / 005-002.600
	BSP 1/4"
	8 424835 007164

	<b>WK500990</b> 20 / 005-002.600
	BSP 1/4"
	8 424835 009366

**Racor rápido**  
**Quick fitting**  
 União rápida

**Cuerpo de acero inoxidable**  
**Conexión de rosca hembra**

Stainless-steel body  
 Female thread connection

Corpo de aço inoxidável  
 Conexão de rosca fêmea



**Racor rápido**  
**Quick fitting**  
 União rápida

**Cuerpo de acero inoxidable**  
**Conexión de rosca macho**

Stainless-steel body  
 Male thread connection

Corpo de aço inoxidável  
 Conexão de rosca macho



	<b>WK501010</b> 20 / 005-000.800
	BSP 1/4"
	8 424835 009380

	<b>WK500390</b> 20 / 005-000.800
	BSP 1/4"
	8 424835 007171

**Racor rápido**  
**Quick fitting**  
 União rápida

**Cuerpo de acero inoxidable**  
**Conexión de espiga**

Stainless-steel body  
 Barb connection

Corpo de aço inoxidável  
 Conexão de espiga



	<b>WK500400</b> 20 / 005-000.800	<b>WK500410</b> 20 / 005-000.800	<b>WK500420</b> 20 / 005-000.800
	8 MM	10 MM	12 MM
	8 424835 007188	8 424835 007195	8 424835 007201



## Espiral Manguera Neumática

### Pneumatic Coiled Hose

Espiral Mangueira Pneumática

**Cuerpo de poliuretano**  
**Conexiones de rosca macho**  
**Ligera y flexible**

Polyurethane body  
 Male thread connections  
 Light and flexible

Corpo de poliuretano  
 Conexões de rosca macho  
 Leve e flexível



	<b>WK500190</b> 10 / 001-006.000	<b>WK500200</b> 10 / 001-009.000
	10 M	15 M
	5 X 8 MM	5 X 8 MM
	BSP 1/4"	BSP 1/4"
	10 BAR	10 BAR
	-5 ≤ 60° C	-5 ≤ 65° C
	8 424835 000639	8 424835 003586

## Manguera Neumática

### Pneumatic Hose

Mangueira Pneumática

**Cuerpo de poliuretano y PVC**  
**Conexiones de rosca macho**  
**Ligera y flexible**

Poliurethane and PVC body  
 Male thread connections  
 Light and flexible

Corpo de poliuretano e PVC  
 Conexões de rosca macho  
 Leve e flexível



	<b>WK500360</b> 10 / 001-013.000	<b>WK500370</b> 10 / 001-018.000
	10 M	15 M
	8 X 15 MM	8 X 15 MM
	BSP 1/4"	BSP 1/4"
	20 BAR	20 BAR
	-5 ≤ 60° C	-5 ≤ 65° C
	8 424835 002305	8 424835 000660

# Herramientas Manuales

## Hand Tools

Ferramentas Manuais



## Pistola Cartuchos

### Caulking Gun

Pistola Cartuchos

**Cuerpo de aluminio anodizado y acero carbono forjado**

**Mango ergonómico y antideslizante**

**Varilla interior de alta aleación**

**Émbolo reforzado de 9 mm**

**Mango y gatillo reforzados**

**Grosor del tubo de 1.5 mm**

**Compatible con cartuchos universales**

**Función anti-goteo**

Anodized aluminum and forged carbon steel body

Ergonomic and non-slip handle

High alloy inner rod

Reinforced piston of 9 mm

Reinforced handle and trigger

Tube thickness of 1.5 mm

Compatible with universal cartridges

No-drip function

Corpo de alumínio anodizado e aço carbono forjado

Cabo ergonômico e antiderrapante

Varinha interna de alta liga

Punho e gatilho reforçados

Êmbolo reforçado de 9 mm

Espessura do tubo de 1.5 mm

Compatível com cartuchos universais

Função anti-gotejamento



## Pistola Cartuchos

### Caulking Gun

Pistola Cartuchos

**Cuerpo de aluminio anodizado y acero carbono forjado**

**Mango ergonómico y antideslizante**

**Varilla interior de alta aleación**

**Émbolo reforzado de 10 mm**

**Mango y gatillo reforzados**

**Grosor del tubo de 1.6 mm**

**Compatible con cartuchos universales**

**Función anti-goteo**

Anodized aluminum and forged carbon steel body

Ergonomic and non-slip handle

High alloy inner rod

Reinforced piston of 10 mm

Reinforced handle and trigger

Tube thickness of 1.6 mm

Compatible with universal cartridges

No-drip function

Corpo de alumínio anodizado e aço carbono forjado

Cabo ergonômico e antiderrapante

Varinha interna de alta liga

Punho e gatilho reforçados







Êmbolo reforçado de 10 mm

Espessura do tubo de 1.6 mm







Compatível com cartuchos universais

Função anti-gotejamento



	<b>WK602420</b> 12 / 001-006.600
	300 ML
	50 MM
	225 MM
	1800 N
	12:1
	8 424835 009960



	<b>WK602430</b> 12 / 001-009.000
	300 ML
	50 MM
	225 MM
	4000 N
	26:1
	8 424835 009977



## Pistola Cartuchos Caulking Gun

Pistola Cartuchos

**Cuerpo de aluminio anodizado y acero carbono forjado**  
**Mango acolchado de caucho**  
**Mango ergonómico y antideslizante**  
**Varilla interior de alta aleación**  
**Émbolo reforzado de 11 mm**  
**Mango y gatillo reforzados**  
**Grosor del tubo de 1.8 mm**  
**Compatible con cartuchos universales**  
**Función anti-goteo**

Anodized aluminum and forged carbon steel body  
 Rubber padded handle  
 Ergonomic and non-slip handle  
 High alloy inner rod  
 Reinforced piston of 11 mm  
 Reinforced handle and trigger  
 Tube thickness of 1.8 mm  
 Compatible with universal cartridges  
 No-drip function

Corpo de alumínio anodizado e aço carbono forjado  
 Cabo acolchado de borracha  
 Cabo ergonômico e antiderrapante  
 Varinha interna de alta liga  
 Êmbolo reforçado de 11 mm  
 Punho e gatilho reforçados  
 Espessura do tubo de 1.8 mm  
 Compatível com cartuchos universais  
 Função anti-gotejamento



## Pistola Cartuchos Tubular Tubular Caulking Gun

Pistola Cartuchos Tubular

**Cuerpo de aluminio anodizado y acero carbono forjado**  
**Mango acolchado de caucho**  
**Mango ergonómico y antideslizante**  
**Varilla interior de alta aleación**  
**Émbolo reforzado de 11 mm**  
**Mango y gatillo reforzados**  
**Grosor del tubo de aluminio de 1.2 mm**  
**Compatible con cartuchos universales**  
**Función anti-goteo**  
**Incluye boquilla**

Anodized aluminum and forged carbon steel body  
 Rubber padded handle  
 Ergonomic and non-slip handle  
 High alloy inner rod  
 Reinforced piston of 11 mm  
 Reinforced handle and trigger  
 Aluminium tube thickness of 1.2 mm  
 Compatible with universal cartridges  
 No-drip function  
 Includes nozzle

Corpo de alumínio anodizado e aço carbono forjado  
 Cabo acolchado de borracha  
 Cabo ergonômico e antiderrapante  
 Varinha interna de alta liga  
 Êmbolo reforçado de 11 mm  
 Punho e gatilho reforçados  
 Espessura do tubo de alumínio de 1.2 mm  
 Compatível com cartuchos universais  
 Função anti-gotejamento  
 Inclui boquilha



	<b>WK602630</b> 12 / 001-012.000
	300 ML
	50 MM
	225 MM
	4000 N
	26:1
	8 424835 010997



	<b>WK602610</b> 12 / 001-012.600	<b>WK602620</b> 12 / 001-014.600
	300 ML	600 ML
	50 MM	50 MM
	225 MM	375 MM
	4000 N	4000 N
	26:1	26:1
	8 424835 010973	8 424835 010980



# Espátula

## Scraper

### Espátula

**Cuerpo de acero inoxidable**

**Mango de ABS composite**

**Mango ergonómico y antideslizante**

**Tope de golpe metálico**

Stainless-steel body

Composite ABS handle

Ergonomic and non-slip handle

Metallic hit end

Corpo de aço inoxidável

Cabo de ABS composite

Cabo ergonômico e antiderrapante

Tope de golpe metálico



Ø I	<b>WK600280</b> 12 / 012-001.300	<b>WK600290</b> 12 / 012-001.350	<b>WK600300</b> 12 / 012-001.400	<b>WK600310</b> 12 / 012-001.450
↔	20 MM	30 MM	40 MM	50 MM
↑ ↓	90 MM	90 MM	90 MM	90 MM
∨ ∧	0.5 MM	0.5 MM	0.5 MM	0.5 MM
	8 424835 003715	8 424835 001452	8 424835 001469	8 424835 001476

Ø I	<b>WK600320</b> 12 / 012-001.500	<b>WK600330</b> 12 / 012-001.550	<b>WK600340</b> 12 / 012-001.600	<b>WK600350</b> 12 / 012-001.650	<b>WK600360</b> 12 / 012-001.700
↔	60 MM	70 MM	80 MM	90 MM	100 MM
↑ ↓	100 MM	100 MM	100 MM	100 MM	100 MM
∨ ∧	0.5 MM	0.5 MM	0.5 MM	0.5 MM	0.5 MM
	8 424835 002282	8 424835 002275	8 424835 000165	8 424835 000172	8 424835 000189



## Espátula Multifunción

### Multi-Function Scraper

Espátula Multifunção

**Cuerpo de acero inoxidable**  
**Mango de ABS composite**  
**Mango ergonómico y antideslizante**  
**Tope de golpe metálico**

Stainless-steel body  
 Composite ABS handle  
 Ergonomic and non-slip handle  
 Metallic hit end

Corpo de aço inoxidável  
 Cabo de ABS composite  
 Cabo ergonómico e antiderrapante  
 Tope de golpe metálico



	<b>WK600270</b> 12 / 012-001.700
	70 MM
	110 MM
	0.5 MM
	8 424835 003708

## Espátula Yeso

### Drywall Scraper

Espátula Gesso

**Cuerpo de acero inoxidable - Mango de ABS composite**  
**Mango ergonómico y antideslizante**  
**Puntas de atornillado de cromo vanadio**  
**Puntas de atornillado magnéticas**  
**Tope de golpe metálico**  
**Incluye 2 puntas de atornillado**

Stainless-steel body - Composite ABS handle  
 Ergonomic and non-slip handle  
 Chrome vanadium screw bits  
 Magnetic screw bits  
 Metallic hit end  
 Includes 2 screw bits

Corpo de aço inoxidável - Cabo de ABS composite  
 Cabo ergonómico e antiderrapante  
 Pontas de aparafusado de cromo vanádio  
 Pontas de aparafusado magnéticas  
 Tope de golpe metálico  
 Inclui 2 puntas de aparafusado



	<b>WK601700</b> 12 / 006-003.200
	150 MM
	110 MM
	0.5 MM
	8 424835 006815

## Juego Espátulas Enmasillar

### Putty Scraper Set

Jogo Espátulas Enmasillar

**Cuerpo de ABS composite**  
**Mango antideslizante**

Composite ABS body  
 Non-slip handle

Corpo de ABS composite  
 Cabo antiderrapante



	<b>WK601540</b> 12 / 006-001.400
	50-120 MM
	110 MM
	3 MM
PCS	4
	8 424835 006310

## Juego Espátulas Enmasillar

### Putty Scraper Set

Jogo Espátulas Enmasillar

**Cuerpo de acero**  
**Mango de ABS composite**  
**Mango antideslizante**

Steel body  
 Composite ABS handle  
 Non-slip handle

Corpo de aço  
 Cabo de ABS composite  
 Cabo antiderrapante



	<b>WK601560</b> 12 / 006-003.000
	50-120 MM
	110 MM
	3 MM
PCS	4
	8 424835 006327

# Espátula Emplastecer

## Taping Knife

Espátula Amassar

**Cuerpo de acero inoxidable**

**Mango y soporte de ABS composite**

**Mango ergonómico y antideslizante**

Stainless-steel body

Composite ABS handle and support

Ergonomic and non-slip handle

Corpo de aço inoxidável

Cabo e suporte de ABS composite

Cabo ergonômico e antiderrapante



Ø I	<b>WK600370</b> 10 / 010-001.600	<b>WK600380</b> 10 / 010-001.700	<b>WK600390</b> 10 / 010-001.800
↔	120 MM	140 MM	160 MM
↑ ↓	90 MM	90 MM	90 MM
∨ ∧	0.5 MM	0.5 MM	0.5 MM
	8 424835 000509	8 424835 000592	8 424835 000523

Ø I	<b>WK600400</b> 10 / 010-001.900	<b>WK600410</b> 10 / 010-002.000	<b>WK600420</b> 10 / 010-002.100	<b>WK600430</b> 10 / 010-002.200
↔	180 MM	200 MM	220 MM	240 MM
↑ ↓	90 MM	90 MM	90 MM	90 MM
∨ ∧	0.5 MM	0.5 MM	0.5 MM	0.5 MM
	8 424835 000530	8 424835 000585	8 424835 000882	8 424835 000899

## Espátula Emplastecer

### Taping Knife

Espátula Amassar

**Cuerpo de acero inoxidable**  
**Mango y soporte de ABS composite**  
**Mango ergonómico y antideslizante**  
**Uso lateral izquierda y derecha**

Stainless-steel body  
 Composite ABS handle and support  
 Ergonomic and non-slip handle  
 Left and right lateral use

Corpo de aço inoxidável  
 Cabo e suporte de ABS composite  
 Cabo ergonômico e antiderrapante  
 Uso lateral esquerda e direita



Ø I	<b>WK601820</b> 10 / 005-003.200	<b>WK601830</b> 10 / 005-004.000	<b>WK601840</b> 10 / 005-004.800
←→	200 MM	250 MM	350 MM
↑ ↓	60 MM	60 MM	60 MM
∨ ∧	0.5 MM	0.5 MM	0.5 MM
	8 424835 007683	8 424835 007690	8 424835 007706

## Espátula Emplastecer

### Taping Knife

Espátula Amassar

**Cuerpo de acero azul**  
**Mango de ABS composite y soporte de aluminio anodizado**  
**Mango ergonómico y antideslizante**  
**Tope de golpe metálico**

Blue steel body  
 Composite ABS handle and anodized aluminium support  
 Ergonomic and non-slip handle  
 Metallic hit end

Corpo de aço azul  
 Cabo de ABS composite e suporte de alumínio anodizado  
 Cabo ergonômico e antiderrapante  
 Tope de golpe metálico



Ø I	<b>WK602250</b> 6 / 006-003.000	<b>WK602260</b> 6 / 006-003.400	<b>WK602270</b> 6 / 006-003.800	<b>WK602280</b> 6 / 006-004.200	<b>WK602290</b> 6 / 006-004.600
←→	150 MM	200 MM	250 MM	300 MM	350 MM
↑ ↓	90 MM	90 MM	90 MM	90 MM	90 MM
∨ ∧	0.5 MM	0.5 MM	0.5 MM	0.5 MM	0.5 MM
	8 424835 009175	8 424835 009182	8 424835 009199	8 424835 009205	8 424835 009212



# Espátula Emplastecer

## Taping Knife

Espátula Amassar

**Cuerpo de acero inoxidable**

**Mango de aluminio anodizado**

**Mango ergonómico y antideslizante**

**Protección lateral contra impactos y entrada de fluido**

**Fijación de la hoja mediante tornillos**

Stainless-steel body

Anodized aluminum handle

Ergonomic and non-slip handle

Side impact and fluid entry protection

Blade fixing by screws

Corpo de aço inoxidável

Cabo de alumínio anodizado

Cabo ergonômico e antiderrapante

Proteção contra impacto lateral e entrada de fluido

Fixação da lâmina por parafusos



Ø I	WK602590 10 / 001-009.600	WK602510 10 / 001-013.600	WK602520 10 / 001-019.600	WK602530 10 / 001-025.600	WK602600 10 / 001-031.600
↔	200 MM	300 MM	500 MM	800 MM	1000 MM
↑ ↓	85 MM	85 MM	85 MM	85 MM	85 MM
∇ ∧	0.5 MM	0.5 MM	0.5 MM	0.5 MM	0.5 MM
	8 424835 010928	8 424835 010638	8 424835 010645	8 424835 010652	8 424835 010935



# Juego Espátulas Emplastecer Mango Telescópico

## Telescopic Handle Taping Knife Set

Jogo Espátulas Amassar Cabo Telescópico

**Cuerpo de acero inoxidable**

**Mango de aluminio anodizado**

**Mango ergonómico y antideslizante**

**Protección lateral contra impactos y entrada de fluido**

**Fijación de la hoja mediante tornillos**

**Incluye mango telescópico de aluminio anodizado de 850-2050 mm**

**Incluye 3 espátulas de emplastecer de 300, 500 y 800 mm**

**Incluye 3 hojas de repuesto de 300, 500 y 800 mm**

**Incluye maletín de transporte de HDPE**

Stainless-steel body

Anodized aluminum handle

Ergonomic and non-slip handle

Side impact and fluid entry protection

Blade fixing by screws

Includes anodized aluminum telescopic handle of 850-2050 mm

Includes 3 taping knives of 300, 500 and 800 mm

Includes 3 replacement blades of 300, 500 and 800 mm

Includes HDPE transportation case

Corpo de aço inoxidável

Cabo de alumínio anodizado

Cabo ergonômico e antiderrapante

Proteção contra impacto lateral e entrada de fluido

Fixação da lâmina por parafusos

Inclui cabo telescópico de alumínio anodizado de 850-2050 mm

Inclui 3 espátulas de amassar de 300, 500 e 800 mm

Inclui 3 lâminas de reposição de 300, 500 e 800 mm

Inclui mala de transporte de HDPE



01	<b>WK602540</b> 4 / 001-098.000
↔	300 / 500 / 800 MM
↑↓	85 MM
✂	0.5 MM
∠x°	0-180°
	8 424835 010669



## Espátula Ángulos Exteriores

### Exterior Angle Trowel

Espátula Ângulos Exteriores

**Cuerpo de acero inoxidable**

**Mango de ABS composite**

**Mango ergonómico y antideslizante**

**Juntas con soldadura TIG**

Stainless-steel body

Composite ABS handle

Ergonomic and non-slip handle

TIG welding joints





Corpo de aço inoxidável

Cabo de ABS composite

Cabo ergonômico e antiderrapante

Juntas com soldadura TIG



	<b>WK602330</b> 10 / 001-004.000
	100 MM
	90 MM
	0.5 MM
	8 424835 009632

## Espátula Ángulos Interiores

### Interior Angle Trowel

Espátula Ângulos Interiores

**Cuerpo de acero inoxidable**

**Mango de ABS composite**

**Mango ergonómico y antideslizante**

**Juntas con soldadura TIG**

Stainless-steel body

Composite ABS handle

Ergonomic and non-slip handle

TIG welding joints





Corpo de aço inoxidável

Cabo de ABS composite

Cabo ergonômico e antiderrapante

Juntas com soldadura TIG



	<b>WK602340</b> 10 / 001-004.000
	100 MM
	90 MM
	0.5 MM
	8 424835 009649

## Llana Decorador

### Decorator Trowel

#### Talocha Decorador

**Cuerpo de acero inoxidable**

**Mango de ABS composite**

**Mango ergonómico y antideslizante**

**Juntas con soldadura TIG**

Stainless-steel body

Composite ABS handle

Ergonomic and non-slip handle

TIG welding joints

Corpo de aço inoxidável

Cabo de ABS

Agarramento ergonômico antiderrapante

Juntas com soldadura TIG



Ø 	<b>WK600960</b> 12 / 001-003.800	<b>WK601010</b> 12 / 001-004.400
↕	200 MM	240 MM
↔	80 MM	110 MM
∨ ∧	0.6 MM	0.6 MM
	8 424835 006105	8 424835 006112

## Llana Rectangular

### Rectangular Trowel

#### Talocha Rectangular

**Cuerpo de acero inoxidable**

**Mango de ABS composite**

**Mango ergonómico y antideslizante**

**Juntas con soldadura TIG**

Stainless-steel body

Composite ABS handle

Ergonomic and non-slip handle

TIG welding joints

Corpo de aço inoxidável

Cabo de ABS composite

Cabo ergonômico e antiderrapante

Juntas com soldadura TIG



Ø 	<b>WK600230</b> 12 / 001-004.200	<b>WK601060</b> 12 / 001-004.800
↕	280 MM	300 MM
↔	120 MM	150 MM
∨ ∧	0.7 MM	0.7 MM
	8 424835 002862	8 424835 006129

## Talocha Rectangular

### Rectangular Trowel

#### Talocha Rectangular

**Cuerpo de ABS composite**  
**Mango de madera**

Composite ABS body  
Wooden handle

Corpo de ABS composite  
Cabo de madeira



⊙ I	<b>WK600250</b> 12 / 006-002.200
↑ ↓	270 MM
← →	180 MM
∨ ∧	10 MM
	8 424835 003579

## Talocha Rectangular

### Rectangular Trowel

#### Talocha Rectangular

**Cuerpo de poliestireno**  
**Acolchado de esponja**  
**Mango ergonómico y antideslizante**

Polystyrene body  
Sponge padding  
Ergonomic and non-slip handle

Corpo de poliestireno  
Acolchado de esponja  
Cabo ergonômico e antiderrapante



⊙ I	<b>WK601870</b> 12 / 001-003.800
↑ ↓	280 MM
← →	140 MM
∨ ∧	30 MM
	8 424835 007874

## Talocha Rectangular

### Rectangular Trowel

#### Talocha Rectangular

**Cuerpo de aluminio anodizado**  
**Mango de madera**  
**Acolchado de EVA-goma**  
**Mango ergonómico y antideslizante**

Anodized aluminium body  
 Wood handle  
 EVA-rubber padding  
 Ergonomic and non-slip handle

Corpo de alumínio anodizado  
 Cabo de madeira  
 Acolchado de EVA-borracha  
 Cabo ergonômico e antiderrapante



⊙ 	<b>WK601890</b> 12 / 001-004.600
↕	240 MM
↔	100 MM
∨ ∧	20 MM
	8 424835 007898



## Talocha Rectangular

### Rectangular Trowel

#### Talocha Rectangular

**Cuerpo de poliestireno**  
**Acolchado de caucho-espuma**  
**Mango ergonómico y antideslizante**

Polystyrene body  
 Rubber-foam padding  
 Ergonomic and non-slip handle

Corpo de poliestireno  
 Acolchado de borracha-espuma  
 Cabo ergonômico e antiderrapante



⊙ 	<b>WK601880</b> 12 / 001-005.600
↕	280 MM
↔	140 MM
∨ ∧	20 MM
	8 424835 007881

## Lijadora Rectangular Paredes

### Rectangular Wall Sander

Lixadora Rectangular Paredes

**Cuerpo de ABS composite**

**Acolchado de EVA**

**Mango ergonómico y antideslizante**

**Fijación de la hoja con clip de ajuste**

Composite ABS body

EVA padding

Ergonomic and non-slip handle

Adjustment clip sheet fixing

Corpo de ABS composite

Acolchado de EVA

Cabo ergonômico e antiderrapante

Fixação da folha clipe de ajuste



	<b>WK600110</b> 12 / 006-002.800
	210 MM
	105 MM
	4 MM
	8 424835 001193

## Lijadora Rectangular Paredes

### Rectangular Wall Sander

Lixadora Rectangular Paredes

**Cuerpo de ABS composite**

**Acolchado de EVA**

**Mango ergonómico y antideslizante**

**Fijación de la hoja con clip de ajuste**

Composite ABS body

EVA padding

Ergonomic and non-slip handle

Adjustment clip sheet fixing

Corpo de ABS composite

Acolchado de EVA

Cabo ergonômico e antiderrapante

Fixação da folha clipe de ajuste



	<b>WK600120</b> 12 / 006-003.200
	230 MM
	105 MM
	6 MM
	8 424835 001087

## Lijadora Rectangular Paredes-Techos

### Rectangular Wall-Ceiling Sander

Lixadora Rectangular Paredes-Tetos

**Cuerpo de ABS composite**

**Acolchado de EVA**

**Mango ergonómico y antideslizante**

**Mango con entrada para mango de extensión**

**Cabezal orientable bidireccional**

**Fijación de la hoja con clip de ajuste**

Composite ABS body

EVA padding

Ergonomic and non-slip handle

Handle with extension handle entry

Bidirectional adjustable head

Adjustment clip sheet fixing

Corpo de ABS composite

Acolchado de EVA

Cabo ergonômico e antiderrapante

Cabo com entrada para cabo de extensão

Cabeça ajustável bidireccional

Fixação da folha clipe de ajuste



	<b>WK600130</b> 12 / 006-003.600
	210 MM
	105 MM
	6 MM
	0-180°
	8 424835 000875

## Lijadora Circular Paredes-Techos

### Circular Wall-Ceiling Sander

Lixadora Circular Paredes-Tetos

**Cuerpo de ABS composite**

**Mango ergonómico y antideslizante**

**Mango con entrada para mango de extensión**

**Cabezal orientable bidireccional**

**Fijación del disco con velcro**

**Incluye 3 discos de lijado de 225 mm**

Composite ABS body

Ergonomic and non-slip handle

Handle with extension handle entry

Bidirectional adjustable head

Disc fixing with velcro

Includes 3 sanding disc of 225 mm

Corpo de ABS composite

Cabo ergonômico e antiderrapante

Cabo com entrada para cabo de extensão

Cabeça ajustável bidireccional

Fixação do disco com velcro

Inclui 3 discos de lixado de 225 mm



	<b>WK601760</b> 20 / 001-009.000
	225 MM
	8 MM
	0-180°
	8 424835 007386



## Cepillo Alambre

### Wire Brush

Escova Arame

**Cuerpo de ABS composite**

**Púas de acero inoxidable**

**Mango ergonómico y antideslizante**

Composite ABS body

Stainless-steel spikes

Ergonomic and non-slip handle

Corpo de ABS composite

Púas de aço inoxidável

Cabo ergonômico e antiderrapante



	<b>WK600050</b> 12 / 006-001.200
	165 MM
	39
	20 MM
	8 424835 002565



## Cepillo Alambre

### Wire Brush

Escova Arame

**Cuerpo de ABS composite**

**Púas de acero carbono forjado**

**Mango ergonómico y antideslizante**

Composite ABS body

Forged carbon steel spikes

Ergonomic and non-slip handle

Corpo de ABS composite

Púas de aço carbono forjado

Cabo ergonômico e antiderrapante



	<b>WK600060</b> 6 / 006-002.200	<b>WK600070</b> 6 / 006-002.800
	220 MM	280 MM
	48	72
	30 MM	30 MM
	8 424835 002701	8 424835 002619

## Cepillo Alambre

### Wire Brush

Escova Arame

**Cuerpo de ABS composite**

**Púas de acero carbono forjado**

**Mango ergonómico y antideslizante**

Composite ABS body

Forged carbon steel spikes

Ergonomic and non-slip handle

Corpo de ABS composite

Púas de aço carbono forjado

Cabo ergonômico e antiderrapante



○ ┃	<b>WK600090</b> 6 / 006-002.800	<b>WK600100</b> 6 / 006-003.200
↕	340 MM	340 MM
●●●●	76	114
↓ ↓ ↓	25 MM	25 MM
	8 424835 003494	8 424835 003500



## Cepillo Alambre

### Wire Brush

Escova Arame

**Cuerpo de ABS composite**

**Púas de acero carbono forjado**

**Mango ergonómico y antideslizante**

Composite ABS body

Forged carbon steel spikes

Ergonomic and non-slip handle

Corpo de ABS composite

Púas de aço carbono forjado

Cabo ergonômico e antiderrapante



○ ┃	<b>WK600030</b> 6 / 006-003.600
↕	210 MM
●●●●	96
↓ ↓ ↓	30 MM
	8 424835 002169

## Sierra Yeso

### Drywall Saw

Serra Gesso

**Cuerpo de ABS composite**

**Hoja de acero inoxidable**

**Mango ergonómico y antideslizante**

**Incluye funda**

Composite ABS body

Stainless-steel blade

Ergonomic and non-slip handle

Includes holster







Corpo de ABS composite

Lâmina de aço inoxidável

Cabo ergonômico e antiderrapante

Inclui bainha



	<b>WK601770</b>
	10 / 001-004.800
	160 MM
	10-22 MM
	1.5 MM
	38
	8 424835 007393

## Sierra Yeso Plegable

### Foldable Drywall Saw

Serra Gesso Dobrável

**Cuerpo de ABS composite**

**Hoja de acero inoxidable**

**Mango ergonómico y antideslizante**

**Plegable en 3 posiciones**

Composite ABS body

Stainless-steel blade

Ergonomic and non-slip handle

Foldable in 3 positions







Corpo de ABS composite

Lâmina de aço inoxidável

Cabo ergonômico e antiderrapante

Dobrável em 3 posições



	<b>WK601780</b>
	10 / 001-006.800
	130 MM
	10-22 MM
	1.2 MM
	35
	8 424835 007409

## Serrucho Yeso

### Drywall Saw

Serra Gesso

**Cuerpo de ABS composite**

**Hoja de acero carbono forjado**

**Mango ergonómico y antideslizante**

**Mango con protector de puño**

Composite ABS body

Forged carbon steel blade

Ergonomic and non-slip handle

Fist protector handle

Corpo de ABS composite

Lâmina de aço carbono forjado

Cabo ergonômico e antiderrapante

Cabo com protetor de punho



⊙ 	<b>WK601980</b> 12 / 001-005.000
↑ ↓	500 MM
← →	40-120 MM
∞	1 MM
∟	140 / 7x"
	8 424835 008550

## Hacha-Martillo Yeso

### Drywall Axe-Hammer

Machado-Martelo Gesso

**Cuerpo de fibra de carbono**

**Cabezal de acero carbono forjado**

**Cabezal tratado térmicamente para durezas extremas**

**Mango ergonómico y antideslizante**

Carbon fiber body

Forged carbon steel head

Heat treated head for extreme hardnesses

Ergonomic and non-slip handle

Corpo de fibra de carbono

Cabeça de aço carbono forjado

Cabeça tratada termicamente para durezas extremas

Cabo ergonômico e antiderrapante



⊙ 	<b>WK601710</b> 10 / 001-006.000
↑ ↓	300 MM
⏏	600 GR
⊘	175 X 28 X 25 MM
	8 424835 007942

## Rasqueta Pintura

### Paint Scraper

Raspadeira Pintura

**Cuerpo de aluminio anodizado y ABS composite**

**Hoja de acero carbono forjado**

**Mango ergonómico y antideslizante**

**Tope de golpe metálico**

**Incluye hoja de corte de 100 mm**

Anodized aluminum and composite ABS body

Forged carbon steel blade

Ergonomic and non-slip handle

Metallic hit end

Includes 100 mm cutting blade

Corpo de alumínio anodizado e ABS composite

Lâmina de aço carbono forjado

Cabo ergonômico e antiderrapante

Tope de golpe metálico

Inclui lâmina de corte de 100 mm



	<b>WK600520</b> 5 / 001-003.600	<b>WK600530</b> 5 / 001-005.600
	300 MM	600 MM
	100 X 18 MM	100 X 18 MM
	0.6 MM	0.6 MM
	8 424835 002336	8 424835 001919

## Remachadora Tacos Metálicos Expansión

### Metallic Expansion Stud Riveter

Remachadora Tacos Metálicos Expansão

**Cuerpo de acero carbono forjado**

**Mango de caucho**

**Mango ergonómico y antideslizante**

Forged carbon steel body

Rubber handle

Ergonomic and non-slip handle

Corpo de aço carbono forjado

Cabo de borracha

Cabo ergonômico e antiderrapante



	<b>WK602370</b> 40 / 001-006.800
	170 MM
	M-4 / M-5 / M-6
	8 424835 009717

## Punta Tope Profundidad

### Depth Limit Bit

Ponta Tope Profundidade

**Cuerpo de acero inoxidable**

**Punta de cromo vanadio**

**Punta magnética**

Stainless-steel body

Chrome vanadium bit

Magnetic bit

Corpo de aço inoxidável

Ponta de cromo vanádio

Ponta magnética



	<b>WK601930</b> 12 / 012-002.000
	HEX-6
	PH2
PCS	6
	8 424835 008239

## Portapuntas Ajuste Profundidad

### Depth Adjust Bit Holder

Portapuntas Ajuste Profundidade

**Cuerpo de acero inoxidable**

**Punta de cromo vanadio**

**Punta magnética**

**Incluye punta de atornillado PH2**

Stainless-steel body

Chrome vanadium bit

Magnetic bit

Includes PH2 screw bit

Corpo de aço inoxidável

Ponta de cromo vanádio

Ponta magnética

Inclui ponta de aparafusado PH2



	<b>WK601940</b> 12 / 001-003.800
	HEX-6
	PH2
	8 424835 008246



## Tijera Corta Chapa

### Sheet Cut Snip

Tesoura Corta Chapa

**Cuerpo de cromo vanadio**

**Mango de caucho**

**Mango ergonómico y antideslizante**

**Incluye sistema de cierre**

Chrome vanadium body

Rubber handle

Ergonomic and non-slip handle

Includes closing system





Corpo de cromo vanádio

Cabo de borracha

Cabo ergonômico e antiderrapante

Inclui sistema de fecho



	<b>WK601950</b> 36 / 001-005.200
	250 MM
	≤ 1.2 MM
	8 424835 008253



## Cizalla Corta Chapa

### Sheet Cut Shear

Cizalha Corta Chapa

**Cuerpo de acero carbono forjado**

**Mango de caucho**

**Mango ergonómico y antideslizante**

**Incluye cabezal rompe-recoge virutas**

**Incluye sistema de cierre**

Forged carbon steel body

Rubber handle

Ergonomic and non-slip handle

Includes chip breaker-collector

Includes closing system

Corpo de aço carbono forjado





Cabo de borracha

Cabo ergonômico e antiderrapante

Inclui cabeça quebra-junta rebarbas

Inclui sistema de fecho



	<b>WK602380</b> 24 / 001-006.800
	260 MM
	≤ 1.2 MM
	8 424835 009724

## Punzonadora Perfiles

### Profile Stud Crimper

#### Punçonadora Perfis

**Cuerpo de acero carbono forjado**

**Mango de caucho**

**Mango ergonómico y antideslizante**

**Incluye sistema de cierre**

Forged carbon steel body

Rubber handle

Ergonomic and non-slip handle

Includes closing system

Corpo de aço carbono forjado

Cabo de borracha

Cabo ergonômico e antiderrapante

Inclui sistema de fecho



	<b>WK601970</b> 24 / 001-012.400
	260 MM
	0.5-0.8 MM
	8 424835 008376

## Punzonadora Perfiles

### Profile Stud Crimper

#### Punçonadora Perfis

**Cuerpo de acero carbono forjado**

**Mango de caucho**

**Mango ergonómico y antideslizante**

Forged carbon steel body

Rubber handle

Ergonomic and non-slip handle

Corpo de aço carbono forjado

Cabo de borracha

Cabo ergonômico e antiderrapante



	<b>WK601960</b> 24 / 001-013.400
	340 MM
	0.5-0.8 MM
	8 424835 008369



# Sierra Corona

## Hole Saw

Serra Craneana

**Cuerpo de acero carbono forjado**

**Compatible con madera, yeso y plástico**

**Incluye 12 sierras de corona de 19, 22, 29, 32, 39, 44, 51, 64, 78, 89, 102 y 127 mm**

**Incluye 2 conectores**

**Incluye broca piloto**

**Incluye maletín de transporte de HDPE**

Forged carbon steel body

Compatible with wood, plaster and plastic

Includes 12 hole saws of 19, 22, 29, 32, 39, 44, 51, 64, 78, 89, 102 and 127 mm

Includes 2 connectors

Includes pilot drill-bit

Includes HDPE transportation case

Corpo de aço carbono forjado

Compatível com madeira, gesso e plástico

Inclui 12 serras craneanas de 19, 22, 29, 32, 39, 44, 51, 64, 78, 89, 102 e 127 mm

Inclui 2 conectores

Inclui broca piloto

Inclui mala de transporte de HDPE



	<b>WK602060</b> 12 / 001-008.400
	HEX-6 / HEX-8
	19-127 MM
	≤ 26 MM
	8 424835 008970

# Broca Sierra Corona HSS

## HSS Hole Saw Drill-Bit

Broca Serra Craneana HSS

**Cuerpo de acero carbono forjado**

**Compatible con metal, acero inoxidable y aluminio**

**Incluye 5 brocas de sierra de corona de 16, 18, 20, 25 y 30 mm**

Forged carbon steel body

Compatible with metal, stainless-steel and aluminium

Includes 5 hole saw drill-bits of 16, 18, 20, 25 and 30 mm

Corpo de aço carbono forjado

Compatível com metal, aço inoxidável e alumínio

Inclui 5 brocas de serra craneana de 16, 18, 20, 25 e 30 mm



	<b>WK602120</b> 12 / 001-009.800
	HEX-6-7-8
	16-30 MM
	≤ 8 MM
	8 424835 008994

## Cortador Circular Ajustable

### Adjustable Circular Cutter

Cortador Circular Ajustável

**Cuerpo de acero carbono forjado**

**Compatible con madera, yeso y plástico**

**Incluye juego de cuchillas de corte**

**Incluye colector de polvo**

**Incluye broca piloto**

Forged carbon steel body

Compatible with wood, plaster and plastic

Includes set of cutting blades

Includes dust collector

Includes pilot drill-bit

Corpo de aço carbono forjado

Compatível com madeira, gesso e plástico

Inclui jogo de lâminas de corte

Inclui colector de pó

Inclui broca piloto



## Cortador Circular Ajustable

### Adjustable Circular Cutter

Cortador Circular Ajustável

**Cuerpo de acero carbono forjado y acero tungsteno**

**Compatible con madera, yeso y plástico**

**Incluye 2 juegos de cuchillas de corte**

**Incluye colector de polvo y 2 brocas piloto**

**Incluye 5 brocas para hormigón y 5 brocas para madera**

**Incluye lápiz y flexómetro de 2 metros**

**Incluye maletín de transporte de HDPE**

Forged carbon steel and tungsten steel body

Compatible with wood, plaster and plastic

Includes 2 cutting blade sets

Includes dust collector and 2 pilot drill-bits

Includes 5 concrete drill-bits and 5 wood drill-bits

Includes pencil and 2-meter tape measure

Includes HDPE transportation case

Corpo de aço carbono forjado e aço tungstênio

Compatível com madeira, gesso e plástico

Inclui 2 jogos de lâminas de corte

Inclui colector de pó e 2 brocas piloto

Inclui 5 brocas para concreto e 5 brocas para madeira

Inclui lápis e flexômetro 2 metros

Inclui mala de transporte de HDPE



	<b>WK602130</b> 8 / 001-012.000
	HEX-8
	50-180 MM
	≤ 21 MM
	8 424835 009007

	<b>WK602070</b> 10 / 001-052.000
	HEX-10
	30-300 MM
	≤ 30 MM
	8 424835 008987

# Gavetilla Yeso

## Mud Pan





Gavetilha Gesso

**Cuerpo de acero inoxidable**  
**Agarre ergonómico y antideslizante**  
**Juntas reforzadas con soldadura TIG**

Stainless-steel body  
Ergonomic and non-slip grip  
Reinforced TIG welding joints

Corpo de aço inoxidável  
Agarramento ergonômico e antiderrapante  
Juntas reforçadas com soldadura TIG



	<b>WK602350</b> 12 / 001-006.800
	360 X 110 X 90 MM
	0.7 MM
	2 L
	8 424835 009687

# Dispensador-Applicador Yeso

## Drywall Dispenser-Applicator

Dispensador-Applicador Gesso

**Cuerpo de aluminio anodizado**

**Mango ergonómico y antideslizante**

**Cabezal orientable**

**Regulador de fluido**

**Extensible**

Anodized aluminum body

Ergonomic and non-slip handle

Adjustable head

Fluid regulator

Extendable

Corpo de alumínio anodizado





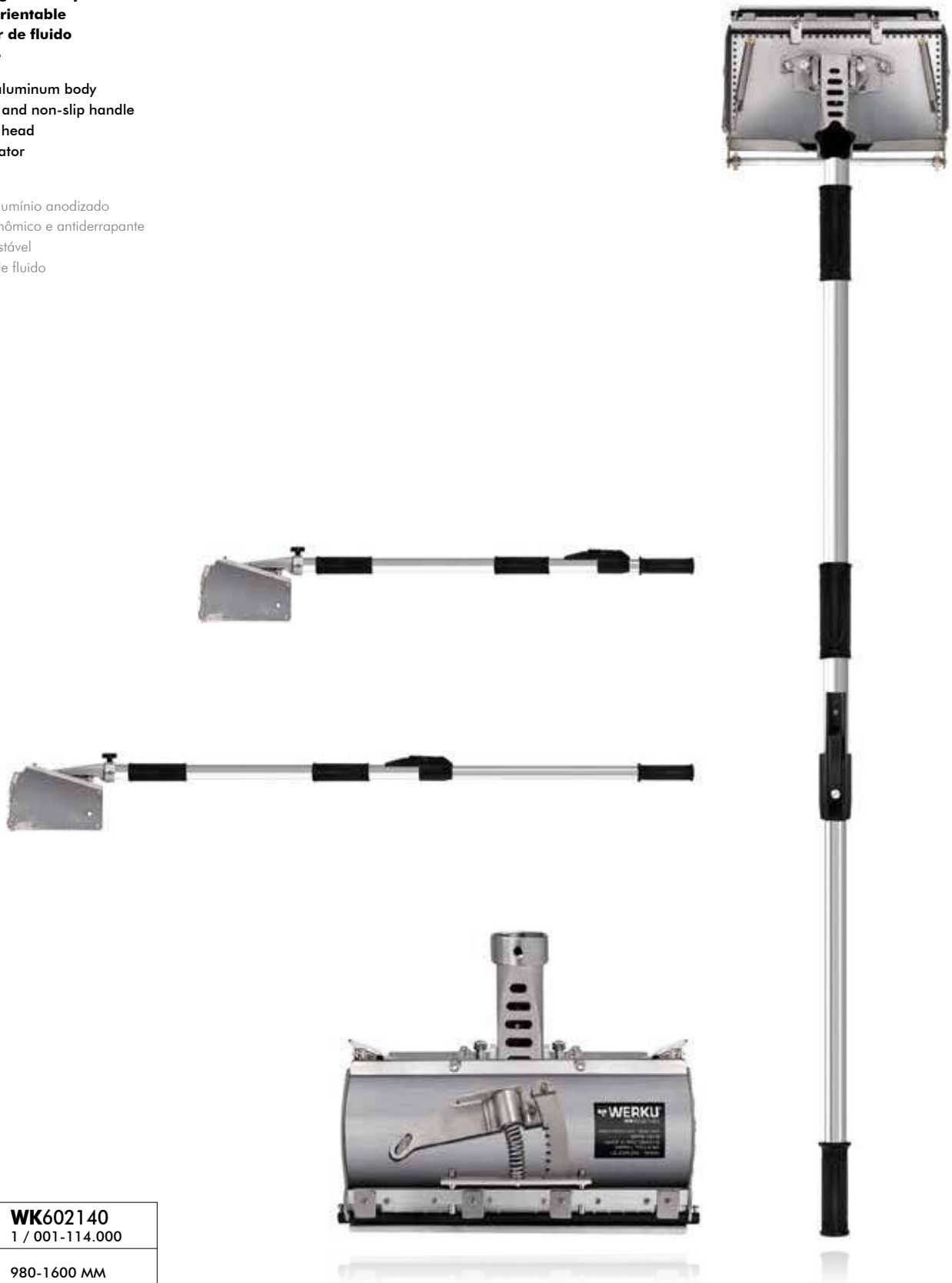

Punho ergonômico e antiderrapante

Cabeça ajustável

Regulador de fluido

Extensível



	<b>WK602140</b> 1 / 001-114.000
	980-1600 MM
	250 MM
	2 L
	0-90° / 0-180°
	8 424835 009069

## Mordaza Rápida

### Quick Clamp

#### Grampo Rápido

**Cuerpo de ABS composite y acero carbono forjado**

**Mango ergonómico y antideslizante**

**Soporte antideslizante**

**Almohadillas de protección**

**Liberación rápida**

**Función reversible**

Composite ABS and forged carbon steel body

Ergonomic and non-slip handle

Anti-slip support

Protection pads

Quick release

Reversible function

Corpo de ABS composite e aço carbono forjado

Cabo ergonômico e antiderrapante

Suporte antiderrapagem

Almofadas de proteção

Liberção rápida

Função reversível



	<b>WK601900</b> 12 / 001-008.400	<b>WK601910</b> 12 / 001-009.400	<b>WK601920</b> 12 / 001-010.400
	150 MM	300 MM	450 MM
	150 KG (daN)	150 KG (daN)	150 KG (daN)
	5.8 X 3.3 MM	5.8 X 3.3 MM	5.8 X 3.3 MM
	8 424835 008130	8 424835 008147	8 424835 008154

## Soporte Extensible

## Extendable Support

Suporte Extensível

Cuerpo de aluminio anodizado

Mango ergonómico y antideslizante

Soporte antideslizante

Cabezal orientable

Liberación rápida

Extensible

Anodized aluminum body

Ergonomic and non-slip handle

Anti-slip support

Adjustable head

Quick release

Extendable

Corpo de alumínio anodizado

Cabo ergonômico e antiderrapante







Suporte antiderrapagem

Cabeça ajustável

Liberação rápida

Extensível



	<b>WK601720</b> 10 / 001-015.600
	1150-2900 MM
	30 KG
	128 X 77 MM
	0-45°
	8 424835 008123

## Carro-Plataforma Porta Paneles-Placas

### Panel-Board Carrier Trolley-Platform

Carro-Plataforma Porta Painéis-Placas

**Cuerpo de acero carbono forjado**

**Ruedas castor de caucho de 120 mm**

**Ruedas traseras orientables en 360 grados**

**Fácilmente desmontable**

Forged carbon steel body

Rubber castor wheels of 120 mm

Adjustable rear wheels in 360 degrees

Easy to disassemble







Corpo de aço carbono forjado

Rodas castor de borracha de 120 mm

Rodas traseiras ajustáveis em 360 graus

Facilmente desmontable



	<b>WK602360</b> 1 / 001-138.000
	900 KG
	4880 X 1220 MM
	1060 X 320 MM
	1230 MM
	8 424835 009700

## Porta Paneles-Placas

### Panel-Board Carrier

Porta Painéis-Placas

**Cuerpo de ABS composite**

**Mango ergonómico y antideslizante**

**Mango angular protector de nudillos**

Composite ABS body

Ergonomic and non-slip handle

Knuckle protector angular handle

Corpo de ABS composite

Cabo ergonômico e antiderrapante

Cabo angular protetor nudillos



	<b>WK602470</b> 24 / 001-004.600
	80 KG
	4880 X 1220 MM
	165 MM
	370 MM
	8 424835 010027

## Soporte Paneles-Placas

### Panel-Board Holder

Suporte Painéis-Placas

**Cuerpo de acero carbono forjado**

**Altura de apoyo regulable**

Forged carbon steel body

Adjustable support height

Corpo de aço carbono forjado

Apoio de altura ajustável



	<b>WK602500</b> 4 / 001-018.000
	80 KG
	4880 X 1220 MM
	810 MM
	8 424835 010058



# Elevador Paneles-Placas Horizontal-Vertical

## Horizontal-Vertical Panel-Plate Lifter

Elevador Painéis-Placas Horizontal-Vertical

**Cuerpo de acero carbono forjado**

**Cable de acero carbono forjado galvanizado**

**Ruedas de caucho de 120 mm**

**Ruedas orientables en 360 grados**

**Ruedas con función de bloqueo**

**Base plegable de 3 patas**

**Elevación horizontal y vertical**

**Elevación mediante sistema de manivela, cable y carraca**

**Función de freno y bloqueo de la elevación**

Forged carbon steel body

Galvanized forged carbon steel cable

Rubber wheels of 120 mm

Adjustable wheels in 360 degrees

Wheels with locking function

3-legged folding base

Horizontal and vertical elevation

Lifting by crank, cable and ratchet system

Brake and lift lock function

Corpo de aço carbono forjado

Cabo de aço carbono forjado galvanizado

Rodas de borracha de 120 mm

Rodas ajustáveis em 360 graus

Rodas com função de bloqueio









Base dobrável de 3 pernas

Elevação horizontal e vertical

Levantamento por sistema de manivela, cabo e catraca

Função de travão e bloqueio da elevação



	<b>WK602150</b> 1 / 001-158.000
	68 KG
	4880 X 1220 MM
	1220-3350 MM
	3 MM
	0-60° / 0-360°
	CE
	8 424835 009076



# Elevador Paneles-Placas Horizontal-Vertical

## Horizontal-Vertical Panel-Plate Lifter

Elevador Painéis-Placas Horizontal-Vertical

**Cuerpo de acero carbono forjado**

**Cable de acero carbono forjado galvanizado**

**Plataformas de madera de 800 x 230 mm**

**Ruedas de caucho de 120 mm**

**Ruedas orientables en 360 grados**

**Ruedas con función de bloqueo**

**Base plegable de 4 patas**

**Elevación horizontal y vertical**

**Elevación mediante sistema de manivela, cable y carraca**

**Función de freno y bloqueo de la elevación**

**Incluye barra de extensión adicional de 500 mm**

Forged carbon steel body

Galvanized forged carbon steel cable

800 x 230 mm wooden platforms

Rubber wheels of 120 mm

Adjustable wheels in 360 degrees

Wheels with locking function

4-legged folding base

Horizontal and vertical elevation

Lifting by crank, cable and ratchet system

Brake and lift lock function

Includes 500 mm additional extension bar

Corpo de aço carbono forjado

Cabo de aço carbono forjado galvanizado

Plataformas de madeira de 800 x 230 mm

Rodas de borracha de 120 mm

Rodas ajustáveis em 360 graus

Rodas com função de bloqueio

Base dobrável de 4 pernas

Elevação horizontal e vertical

Levantamento por sistema de manivela, cabo e catraca

Função de travão e bloqueio da elevação

Inclui barra de extensão adicional de 500 mm



	<b>WK602160</b> 1 / 001-348.000
	75 KG
	4880 X 1220 MM
	1450-3500/4000 MM
	3 MM
	0-60° / 0-360°
	CE
	8 424835 009083

# Carro Portacargas

## Load Carrier Trolley

### Carro Porta-Cargas

**Cuerpo de acero carbono forjado**

**Llantas de acero aleado**

**Ruedas neumáticas de poliuretano de 260 mm**

**Aletas de protección de ruedas y aumento de capacidad de volumen**

**Mangos ergonómicos y antideslizantes**

**Mangos con protector de puños**

Forged carbon steel body

Alloy steel rims

Pneumatic polyurethane wheels of 260 mm

Wheel protection flaps and volume capacity increase

Ergonomic and non-slip handles

Fists protector handles

Corpo de aço carbono forjado

Jantes de liga de aço







Rodas pneumáticas de poliuretano de 260 mm

Asas de proteção das rodas e maior capacidade de volume

Cabos ergonômicos e antiderrapantes

Cabos com protector de punhos



	<b>WK602310</b> 1 / 001-034.000
	200 KG
	350 X 185 MM
	1165 MM
	TÜV GS
	8 424835 009601

# Carro-Plataforma Portacargas

## Load Carrier Trolley-Platform

Carro-Plataforma Porta-Cargas

**Cuerpo de acero carbono forjado**

**Asa de transporte acolchada de caucho**

**Plataforma de poliuretano**

**Ruedas castor de poliuretano de 125 mm**

**Ruedas traseras orientables en 360 grados**

**Mango ergonómico y antideslizante**

**Protección lateral contra impactos**

**Plegable**

Forged carbon steel body

Rubber padded carrying handle

Polyurethane platform

Polyurethane castor wheels of 125 mm

Adjustable rear wheels in 360 degrees

Ergonomic and non-slip handle

Side impact protection

Foldable

Corpo de aço carbono forjado

Alça de transporte acolchoada de borracha

Plataforma de poliuretano

Rodas castor de poliuretano de 125 mm





Rodas traseiras ajustáveis em 360 graus

Cabo ergonômico e antiderrapante

Proteção lateral contra impactos

Dobrável



	<b>WK602320</b> 1 / 001-048.000
	300 KG
	910 X 610 MM
	890 MM
	8 424835 009595

## Rasqueta Pintura

### Paint Scraper

Raspadeira Pintura

**Cuerpo de aluminio anodizado y ABS composite**

**Hoja de acero carbono forjado**

**Mango ergonómico y antideslizante**

**Incluye hoja de corte de 25 mm**

Anodized aluminum and composite ABS body

Forged carbon steel blade

Ergonomic and non-slip handle

Includes 25 mm cutting blade

Corpo de alumínio anodizado e ABS composite

Lâmina de aço carbono forjado

Cabo ergonômico e antiderrapante

Inclui lâmina de corte de 25 mm



	<b>WK600470</b> 6 / 001-005.800
	240 MM
	25 X 25 X 25 MM
	2.0 MM
	8 424835 004651

## Rasqueta Pintura

### Paint Scraper

Raspadeira Pintura

**Cuerpo de aluminio anodizado y ABS composite**

**Hoja de acero carbono forjado**

**Mango ergonómico y antideslizante**

**Incluye hoja de corte de 52 mm**

Anodized aluminum and composite ABS body

Forged carbon steel blade

Ergonomic and non-slip handle

Includes 52 mm cutting blade

Corpo de alumínio anodizado e ABS composite

Lâmina de aço carbono forjado

Cabo ergonômico e antiderrapante

Inclui lâmina de corte de 52 mm



	<b>WK600480</b> 6 / 001-006.800
	250 MM
	52 X 8 MM
	2.0 MM
	8 424835 004644

## Rasqueta Pintura

### Paint Scraper

Raspadeira Pintura

**Cuerpo de aluminio anodizado y ABS composite**

**Hoja de acero carbono forjado**

**Mango auxiliar de soporte**

**Mango ergonómico y antideslizante**

**Incluye hoja de corte de 65 mm**

Anodized aluminum and composite ABS body

Forged carbon steel blade

Support auxiliary handle

Ergonomic and non-slip handle

Includes 65 mm cutting blade

Corpo de alumínio anodizado e ABS composite

Lâmina de aço carbono forjado

Cabo auxiliar de suporte

Cabo ergonômico e antiderrapante

Inclui lâmina de corte de 65 mm



	<b>WK600490</b> 6 / 001-007.800
	290 MM
	65 X 8 MM
	2.0 MM
	8 424835 001384

**Hoja Rasqueta**  
**Scraper Blade**  
 Lâmina Raspadeira





  
**WK600470**

**Cuerpo de acero carbono forjado**  
**Triple filo**

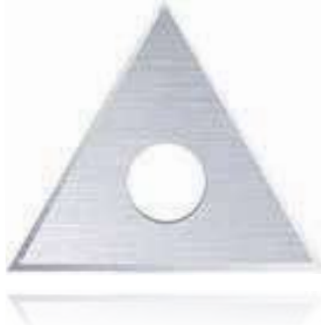
Forged carbon steel body  
 Triple-edged

Corpo de aço carbono forjado  
 Triplo gume



	<b>WK300010</b> 6 / 001-002.200
	25 X 25 X 25 MM
	2.0 MM
	8 424835 002879

**Hoja Rasqueta**  
**Scraper Blade**  
 Lâmina Raspadeira





  
**WK600480**

**Cuerpo de acero carbono forjado**  
**Doble filo**

Forged carbon steel body  
 Double-edged

Corpo de aço carbono forjado  
 Duplo gume



	<b>WK300020</b> 6 / 001-003.200
	52 X 8 MM
	2.0 MM
	8 424835 002886

**Hoja Rasqueta**  
**Scraper Blade**  
 Lâmina Raspadeira





  
**WK600490**

**Cuerpo de acero carbono forjado**  
**Doble filo**

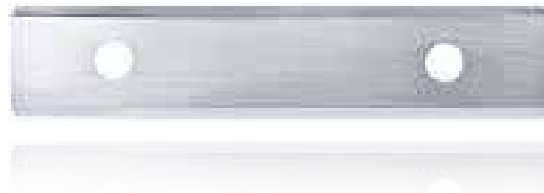
Forged carbon steel body  
 Double-edged

Corpo de aço carbono forjado  
 Duplo gume



	<b>WK300030</b> 6 / 001-003.600
	65 X 8 MM
	2.0 MM
	8 424835 002893

## Cepillo Bordes Paneles-Placas Yeso

### Drywall Panel-Board Edge Plane

Plaina Bordas Painéis-Placas Gesso

**Cuerpo de ABS composite**

**Mango ergonómico**

**Incluye 2 hojas de corte de 23 y 53 mm**

Composite ABS body

Ergonomic handle

Includes 2 cutting blades of 23 and 53 mm

Corpo de ABS composite

Cabo ergonômico

Inclui 2 lâminas de corte de 23 e 53 mm



	<b>WK602480</b> 60 / 001-004.400
	240 MM
	23 X 23 / 53 X 19 MM
	9.5-15 MM
	22.5° / 45°
	8 424835 010034

## Cortador Horizontal-Circular Paneles-Placas Yeso

### Drywall Panel-Board Horizontal-Circular Cutter

Cortador Horizontal-Circular Painéis-Placas Gesso

**Cuerpo de acero carbono forjado y ABS composite**

**Mango ergonómico**

**Medición en centímetros**

**Incluye disco de corte de 30 mm**

Forged carbon steel and composite ABS body

Ergonomic handle

Centimeter measurement

Includes cutting disc of 30 mm

Corpo de aço carbono forjado e ABS composite

Cabo ergonômico

Medição em centímetros

Inclui disco de corte de 30 mm



	<b>WK602490</b> 12 / 001-016.000
	700 MM
	600 MM
	1200 MM
	10 MM
	8 424835 010041

# Nivel Rectangular

## Rectangular Level

Nível Retangular

**Cuerpo de aluminio anodizado**

**Nivelado horizontal, vertical y ajustable 0-90°**

**Protección lateral contra impactos**

**Magnético**

**Medición en centímetros**

Anodized aluminum body

Horizontal, vertical and adjustable 0-90° levelling

Lateral protection against impacts

Magnetic

Centimeter measuring

Corpo de alumínio anodizado





Nivelado horizontal, vertical e ajustável 0-90°

Proteção lateral contra impactos

Magnético

Medição em centímetros



	<b>WK602170</b> 10 / 001-007.600	<b>WK602180</b> 10 / 001-008.600	<b>WK602190</b> 10 / 001-009.600
	600 MM	800 MM	1000 MM
	0.5 MM/M	0.5 MM/M	0.5 MM/M
	CLASS-I	CLASS-I	CLASS-I
	8 424835 009144	8 424835 009151	8 424835 009168



## Rascador Yeso

### Drywall Scraper





Rascador Gesso

**Cuerpo de acero carbono forjado**  
**Mango ergonómico y antideslizante**  
**Juntas con soldadura TIG**

Forged carbon steel body  
Ergonomic and non-slip handle  
TIG welding joints

Corpo de aço carbono forjado  
Cabo ergonômico e antiderrapante  
Juntas com soldadura TIG



	<b>WK600540</b> 10 / 001-006.000
	285 MM
	150 MM
	9
	8 424835 001070

## Rascador Yeso

### Drywall Scraper





Rascador Gesso

**Cuerpo de acero carbono forjado**  
**Mango ergonómico**  
**Juntas con soldadura TIG**

Forged carbon steel body  
Ergonomic handle  
TIG welding joints

Corpo de aço carbono forjado  
Cabo ergonômico  
Juntas com soldadura TIG



	<b>WK600550</b> 10 / 001-012.000
	450 MM
	90 MM
	9
	8 424835 002589

## Tiralíneas Chalk Line

Tira-Linhas

**Cuerpo de ABS composite**  
**Manivela plegable**  
**Incluye polvo tiralíneas de 50 gramos**

Composite ABS body  
Foldable handle  
Includes 50 gram chalk line powder

Corpo de ABS composite  
Manivela dobrável  
Inclui pó tira-linhas de 50 gramos



○ 	<b>WK600200</b> 6 / 001-004.000
↑ ↓	30 M
	8 424835 003722

## Tiralíneas Multiplicador Multiplier Chalk Line

Tira-Linhas Multiplicador

**Cuerpo de ABS composite**  
**Manivela plegable**  
**Función de enrollado rápido**  
**Incluye polvo tiralíneas de 50 gramos**

Composite ABS body  
Foldable handle  
Fast speed rolling function  
Includes 50 gram chalk line powder

Corpo de ABS composite  
Manivela dobrável  
Função de enrolado rápido  
Inclui pó tira-linhas de 50 gramos



○ 	<b>WK600210</b> 6 / 001-005.200
↑ ↓	30 M
	8 424835 003739

## Maza Goma

### Rubber Mallet

Martelo Borracha

**Cuerpo de fibra de carbono**  
**Cabezal de goma**  
**Mango ergonómico y antideslizante**

Carbon fiber body  
 Rubber head  
 Ergonomic and non-slip handle

Corpo de fibra de carbono  
 Cabeçal de borracha  
 Cabo ergonômico e antiderrapante



⊙ I	<b>WK601670</b> 36 / 001-003.400	<b>WK601680</b> 24 / 001-004.200	<b>WK601690</b> 24 / 001-005.600
↑ ↓	310 MM	340 MM	380 MM
⚖	340 GR	450 GR	680 GR
⊘	80 X 50 MM	90 X 55 MM	100 X 60 MM
	8 424835 006679	8 424835 006686	8 424835 006693

## Maceta

### Club Hammer

Maceta

**Cuerpo de fibra de carbono**  
**Cabezal de acero carbono forjado**  
**Cabezal tratado térmicamente para durezas extremas**  
**Mango ergonómico y antideslizante**  
**Unión cabezal y mango reforzada con sistema de fijación eterna de nylon**

Carbon fiber body  
 Forged carbon steel head  
 Heat treated head for extreme hardness  
 Ergonomic and non-slip handle  
 Head and handle union reinforced with eternal nylon fixing system

Corpo de fibra de carbono  
 Cabeçal de aço carbono forjado  
 Cabeçal tratada termicamente para dureza extrema  
 Cabo ergonômico e antiderrapante  
 União cabeçal e cabo reforçada com sistema de fixação eterna de nylon



⊙ I	<b>WK601730</b> 12 / 001-005.400	<b>WK601740</b> 12 / 001-006.400	<b>WK601750</b> 12 / 001-007.400
↑ ↓	265 MM	265 MM	265 MM
⚖	1000 GR	1250 GR	1500 GR
⊘	94 X 40 X 40 MM	98 X 44 X 44 MM	108 X 46 X 46 MM
	8 424835 007300	8 424835 007317	8 424835 007324

# Maceta Club Hammer

Maceta

**Cuerpo de fibra de carbono**

**Cabezal de acero carbono forjado**

**Cabezal tratado térmicamente para durezas extremas**

**Mango ergonómico y antideslizante**

**Unión cabezal y mango reforzada con sistema de fijación eterna de nylon**

Carbon fiber body

Forged carbon steel head

Heat treated head for extreme hardness

Ergonomic and non-slip handle

Head and handle union reinforced with eternal nylon fixing system

Corpo de fibra de carbono





Cabeçal de aço carbono forjado

Cabeçal tratada termicamente para dureza extrema

Cabo ergonômico e antiderrapante

União cabeçal e cabo reforçada com sistema de fixação eterna de nylon



	<b>WK602390</b> 6 / 001-018.000	<b>WK602400</b> 4 / 001-024.000
	910 MM	910 MM
	3 KG	5 KG
	140 X 55 X 55 MM	160 X 67 X 67 MM
	8 424835 009755	8 424835 009762

# Escaleras y Plataformas

## Ladders and Platforms

### Escadas e Plataformas



## Escalera Multiuso

### Multipurpose Ladder

Escada Multiuso

**Cuerpo de aluminio anodizado**  
**Tacos de goma**  
**Fácilmente transportable**  
**Plegable**

Anodized aluminum body  
 Rubber blocks  
 Easily transportable  
 Foldable

Corpo de alumínio anodizado  
 Blocos de borracha  
 Facilmente transportável  
 Dobrável



## Plataforma Escalera Multiuso

### Multipurpose Ladder Platform

Plataforma Escada Multiuso

**Cuerpo de acero galvanizado**  
**Fácilmente montable**  
**Antideslizante**

Galvanized Steel body  
 Easily mountable  
 Non-slip

Corpo de aço galvanizado  
 Facilmente montável  
 Anti-deslizante



WK700010  
 WK700020

	<b>WK700010</b> 1 / 001-078.000	<b>WK700020</b> 1 / 001-094.000
	150 KG	150 KG
	372 CM	472 CM
	102 CM	127 CM
	180 CM	226 CM
	102 CM	127 CM
	4 X 3	4 X 4
	26 CM	26 CM
	35 CM	35 CM
	1.2 MM	1.2 MM
	EN 131-4	EN 131-4
	8 424835 000646	8 424835 000950



	<b>WK700070</b> 10 / 001-010.600	<b>WK700080</b> 10 / 001-013.600
	150 KG	150 KG
	150 CM	205 CM
	32 CM	32 CM
	1 MM	1 MM
	8 424835 006280	8 424835 006297

# Escalera Telescópica Multiuso

## Telescopic Multipurpose Ladder

### Escada Telescópica Multiuso

**Cuerpo de aluminio anodizado**

**Tacos de goma**

**Fácilmente transportable**

**Extensible**

**Plegable**

Anodized aluminum body

Rubber blocks

Easily transportable

Extendable

Foldable

Corpo de alumínio anodizado









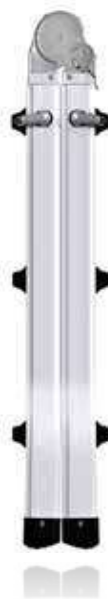

Blocos de borracha

Facilmente transportável

Extensível

Dobrável



	<b>WK700110</b> 1 / 001-108.000	<b>WK700120</b> 1 / 001-128.000
	150 KG	150 KG
	398 CM	510 CM
	120 CM	148 CM
	194 CM	247 CM
	2 X 4+4	2 X 5+5
	28 CM	28 CM
	35 CM	35 CM
	1.2 / 1.5 MM	1.2 / 1.5 MM
	EN 131-4	EN 131-4
	8 424835 006808	8 424835 006792



# Plataforma

## Platform

Plataforma

**Cuerpo de aluminio anodizado**

**Tacos de goma**

**Fácilmente transportable**

**Plegable**

**Antideslizante**

Anodized aluminum body

Rubber blocks

Easily transportable

Foldable

Non-slip

Corpo de alumínio anodizado







Blocos de borracha

Facilmente transportável

Dobrável

Anti-deslizante



	<b>WK700160</b> 1 / 001-064.000	<b>WK700170</b> 1 / 001-070.000
	150 KG	150 KG
	75 CM	75 CM
	75 X 45 CM	100 X 45 CM
	1.5 MM	1.5 MM
	EN 14183	EN 14183
	8 424835 010072	8 424835 010089





## Escalera Ancha

### Wide Ladder

#### Escada Larga

**Cuerpo de acero carbono forjado**

**Asa acolchada de caucho**

**Tacos de goma**

**Fácilmente transportable**

**Plegable**

**Antideslizante**

Forged carbon steel body

Rubber padded handle

Rubber blocks

Easily transportable

Foldable

Non-slip

Corpo de aço carbono forjado

Alça acolchoada de borracha

Blocos de borracha

Facilmente transportável

Dobrável

Anti-deslizante



## Escalera Telescópica

### Telescopic Ladder

#### Escada Telescópica

**Cuerpo de aluminio anodizado**

**Tacos de goma**

**Fácilmente transportable**

**Extensible**

**Función de cierre suave**

Anodized aluminum body

Rubber blocks

Easily transportable

Extendable

Soft close function

Corpo de alumínio anodizado

Blocos de borracha

Facilmente transportável

Extensível

Função de cierre suave



	<b>WK700090</b> 4 / 001-024.000	<b>WK700100</b> 4 / 001-028.000
	150 KG	150 KG
	89 CM	110 CM
	46 CM	46 CM
	2	3
	48 CM	70 CM
	26 X 38 CM	26 X 38 CM
	1.2 MM	1.2 MM
	EN 14183	EN 14183
	8 424835 006167	8 424835 006198



	<b>WK700140</b> 1 / 001-102.000	<b>WK700150</b> 1 / 001-112.000
	150 KG	150 KG
	85-320 CM	91-380 CM
	47 / 81 CM	47 / 86 CM
	10	12
	29 CM	29 CM
	1.3 MM	1.3 MM
	EN 131-6	EN 131-6
	8 424835 009618	8 424835 009625



**Protección y Seguridad**  
**Protection and Safety**  
Proteção e Segurança



## Mascarilla

### Mask

Máscara

**Cuerpo de polipropileno**  
**Clip nasal de acero inoxidable**  
**Almohadilla interior**  
**Bandas elásticas**

Polypropylene body  
 Stainless-steel nose clip  
 Inner pad  
 Elastic bands

Corpo de polipropileno  
 Clipe nasal de aço inoxidável  
 Almofadinha interior  
 Bandas elásticas



EN 149

	<b>WK100130</b> 20 / 001-004.000
	FFP1
	3
	4 X TLV
PCS	10
	CE CAT-II
	8 424835 001278

## Mascarilla

### Mask

Máscara

**Cuerpo de polipropileno**  
**Válvula de exhalación**  
**Clip nasal de acero inoxidable**  
**Almohadilla interior**  
**Bandas elásticas**

Polypropylene body  
 Exhalation valve  
 Stainless-steel nose clip  
 Inner pad  
 Elastic bands

Corpo de polipropileno  
 Válvula de exalação  
 Clipe nasal de aço inoxidável  
 Almofadinha interior  
 Bandas elásticas



EN 149

	<b>WK100150</b> 20 / 001-004.400	<b>WK100160</b> 20 / 001-005.000
	FFP1	FFP2
	3	3
	4 X TLV	12 X TLV
PCS	10	10
	CE CAT-II	CE CAT-II
	8 424835 004705	8 424835 004699

# Mascarilla

## Mask

### Máscara



EN 149

**Cuerpo de polipropileno**  
**Válvula de exhalación**  
**Capa intermedia de carbón activo**  
**Clip nasal de acero inoxidable**  
**Almohadilla interior**  
**Bandas elásticas**

Polypropylene body  
Exhalation valve  
Intermediate layer of activated carbon  
Stainless-steel nose clip  
Inner pad  
Elastic bands

Corpo de polipropileno  
Válvula de exalação  
Camada intermédia de carvão ativado  
Clipe nasal de aço inoxidável  
Almofadinha interior  
Bandas elásticas



	<b>WK100200</b> 20 / 001-005.400
	FFP2
	4
	12 X TLV
PCS	10
	CE CAT-II
	8 424835 004675

# Mascarilla

## Mask

### Máscara



EN 149

- Cuerpo de polipropileno**
- Válvula de exhalación**
- Clip nasal de acero inoxidable**
- Almohadilla interior**
- Acolchado interior**
- Bandas anchas elásticas y ajustables**

- Polypropylene body
- Exhalation valve
- Stainless-steel nose clip
- Inner pad
- Interior padded
- Wide elastic and adjustable bands

- Corpo de polipropileno
- Válvula de exalação
- Clipe nasal de aço inoxidável
- Almofadinha interior
- Acolchoado interior
- Bandas largas elásticas e ajustáveis



	<b>WK100580</b> 40 / 001-008.000
	FFP3
	3
	50 X TLV
PCS	5
	CE CAT-III
	8 424835 007928

# Mascarilla

## Mask

### Máscara



EN 149

**Cuerpo de polipropileno**

**Válvula de exhalación**

**Capa intermedia de carbón activo**

**Clip nasal de acero inoxidable**

**Almohadilla interior**

**Acolchado interior**

**Bandas anchas elásticas y ajustables**

Polypropylene body

Exhalation valve

Intermediate layer of activated carbon

Stainless-steel nose clip

Inner pad

Interior padded

Wide elastic and adjustable bands

Corpo de polipropileno

Válvula de exalação

Camada intermédia de carvão ativado

Clipe nasal de aço inoxidável

Almofadainha interior

Acolchoado interior

Bandas largas elásticas e ajustáveis



	<b>WK100690</b> 40 / 001-009.000
	FFP3
	4
	50 X TLV
PCS	5
	CE CAT-III
	8 424835 007935

# Buzo Desechable

## Disposable Overall

Macação Descartável

**Cuerpo de polipropileno y polietileno**

**Transpirable e impermeable**

**Costuras termoselladas**

**Cierre con cremallera**

**Protección contra polvo; partículas sólidas aéreas (tipo 5)**

**Protección contra líquidos; ligeras salpicaduras líquidas (tipo 6)**

Polypropylene and polyethylene body

Breathable and waterproof

Thermo-sealed seams

Zipper closing

Dust protection; solid airborne particles (type 5)

Liquid protection; light liquid splashes (type 6)

Corpo de polipropileno e polietileno

Transpirável e impermeável

Costuras termoseladas

Fechamento com zíper

Proteção contra pó; partículas sólidas aéreas (tipo 5)

Proteção contra líquidos; leves salpicos líquidos (tipo 6)



EN 13034

EN ISO 13982-1

EN 1073-2

EN 1149-5

EN 14126



TYPE 5B

TYPE 6B



CLASS 2



	<b>WK100420</b> 50 / 010-002.600	<b>WK100430</b> 50 / 010-002.600	<b>WK100440</b> 50 / 010-002.600
	55 GR/M <sup>2</sup>	55 GR/M <sup>2</sup>	55 GR/M <sup>2</sup>
	M	L	XL
	CE CAT-III	CE CAT-III	CE CAT-III
	8 424835 003944	8 424835 003791	8 424835 001490



## Camiseta

### T-Shirt

Camiseta

**Cuerpo de 65% poliéster y 35% algodón**  
**Refuerzos de doble costura**  
**Fondo blanco, con cuello y puños en negro**  
**Transpirable**

Polyester 65% and cotton 35% body  
Double-stitched gussets  
White background, with black collar and cuffs  
Breathable

Corpo de 65% poliéster e 35% algodão  
Reforços de costura dupla  
Fundo branco com pescoço e punhos em preto  
Transpirável



	<b>WK101410</b> 50 / 001-003.600	<b>WK101420</b> 50 / 001-003.600	<b>WK101430</b> 50 / 001-003.600	<b>WK101440</b> 50 / 001-003.600	<b>WK101450</b> 50 / 001-003.600
	180 GR/M <sup>2</sup>	180 GR/M <sup>2</sup>	180 GR/M <sup>2</sup>	180 GR/M <sup>2</sup>	180 GR/M <sup>2</sup>
	S	M	L	XL	2XL
	CE CAT-I	CE CAT-I	CE CAT-I	CE CAT-I	CE CAT-I
	8 424835 008666	8 424835 008673	8 424835 008680	8 424835 008697	8 424835 008703

## Polo

### Polo Shirt

Polo

**Cuerpo de 65% poliéster y 35% algodón**  
**Refuerzos de doble costura**  
**Fondo blanco, con cuello, cierre y puños en negro**  
**Cierre con 3 botones**  
**Transpirable**

Polyester 65% and cotton 35% body  
Double-stitched gussets  
White background, with black collar, closing and cuffs  
Closing with 3 buttons  
Breathable

Corpo de 65% poliéster e 35% algodão  
Reforços de costura dupla  
Fundo branco com pescoço e punhos em preto  
Fechamento com 3 botões  
Transpirável



	<b>WK102820</b> 50 / 001-004.400	<b>WK102830</b> 50 / 001-004.400	<b>WK102840</b> 50 / 001-004.400	<b>WK102850</b> 50 / 001-004.400	<b>WK102860</b> 50 / 001-004.400
	180 GR/M <sup>2</sup>	180 GR/M <sup>2</sup>	180 GR/M <sup>2</sup>	180 GR/M <sup>2</sup>	180 GR/M <sup>2</sup>
	S	M	L	XL	2XL
	CE CAT-I	CE CAT-I	CE CAT-I	CE CAT-I	CE CAT-I
	8 424835 005382	8 424835 005399	8 424835 005405	8 424835 005412	8 424835 005429



# Guantes Nitrilo

## Nitrile Gloves

Luvas Nitrile

**Cuerpo de poliéster**

**Recubrimiento de nitrilo en palma**

**Sin costuras**

**Fondo blanco, recubrimiento negro y puño en blanco-negro**

**Buena resistencia a la abrasión**

**Puño elástico**

Polyester body

Nitrile palm coating

Stitchless

White background, black coating and black-white cuff

Good abrasion resistance

Elastic cuff

Corpo de poliéster

Recobrimento de nitrilo em palma

Sem costuras

Fundo branco, recobrimento preto e punho em preto-branco

Boa resistência à abrasão

Punho elástico



4121X

EN 420

EN 388



	<b>WK101070</b> 120 / 012-000.600	<b>WK101080</b> 120 / 012-000.600	<b>WK100700</b> 120 / 012-000.600
	13	13	13
	M (8)	L (9)	XL (10)
	CE CAT-II	CE CAT-II	CE CAT-II
	8 424835 007133	8 424835 003647	8 424835 003760

## Guantes PU

### PU Gloves

#### Luvás PU

**Cuerpo de poliéster**

**Recubrimiento de poliuretano en palma y dorso**

**Sin costuras**

**Fondo blanco, recubrimiento transparente y puño en blanco**

**Buena resistencia a la abrasión y al rasgado**

**Puño elástico**

Polyester body

Polyurethane palm and back coating

Stitchless

White background, transparent coating and white cuff

Good abrasion and tear resistance

Elastic cuff

Corpo de poliéster

Recobrimento de poliuretano em palma e dorso

Sem costuras

Fundo branco, recobrimento transparente e punho em branco

Boa resistência à abrasão e ao rasgado

Punho elástico



3 1 3 1 X

EN 420

EN 388

	<b>WK101060</b> 120 / 012-000.600	<b>WK101090</b> 120 / 012-000.600	<b>WK100710</b> 120 / 012-000.600
	13	13	13
	M (8)	L (9)	XL (10)
	CE CAT-II	CE CAT-II	CE CAT-II
	8 424835 007140	8 424835 600037	8 424835 003654

## Guantes PU

### PU Gloves

#### Luvás PU

**Cuerpo de poliéster**

**Recubrimiento de poliuretano en palma y dorso**

**Sin costuras**

**Fondo negro, recubrimiento transparente y puño en negro**

**Buena resistencia a la abrasión y al rasgado**

**Puño elástico**

Polyester body

Polyurethane palm and back coating

Stitchless

Black background, transparent coating and black cuff

Good abrasion and tear resistance

Elastic cuff

Corpo de poliéster

Recobrimento de poliuretano em palma e dorso

Sem costuras

Fundo preto, recobrimento transparente e punho em preto

Boa resistência à abrasão e ao rasgado

Punho elástico



3 1 3 1 X

EN 420

EN 388

	<b>WK102700</b> 120 / 012-000.600	<b>WK100030</b> 120 / 012-000.600	<b>WK100040</b> 120 / 012-000.600
	13	13	13
	M (8)	L (9)	XL (10)
	CE CAT-II	CE CAT-II	CE CAT-II
	8 424835 007126	8 424835 003609	8 424835 003753

## Rodilleras Inserción

### Insert Kneepads

Joelheiras Inserção

**Cuerpo de EVA y espuma**

**Función impermeable**





EVA and foam body

Waterproof function

Corpo de EVA e espuma

Função impermeável



	<b>WK100010</b> 40 / 001-003.400
	≥ 100 N
	75 GR
	CE CAT-I
	8 424835 003975

## Rodilleras

### Kneepads

Joelheiras

**Cuerpo de PVC, neopreno y poliéster 600 Denier**

**Relleno de espuma y aire inyectado**

**Bandas de fijación ajustables y con cierre de velcro**

**Función antideslizante**

**Función antimarcado**

**Función antirayadura**

**Función impermeable**

PVC, neoprene and 600 Denier polyester body

Filled with foam and injected air

Anti-slip function

Anti-marking function

Anti-scratch function

Waterproof function

Corpo de PVC, neoprene e poliéster 600 Denier

Recheado de espuma e ar injetado

Bandas de fixação ajustáveis com fecho de velcro







Função antiderrapante

Função anti-marcação

Função anti-riscos

Função impermeável



	<b>WK100290</b> 10 / 001-009.800
	≥ 100 N
	XL
	395 GR
	CE CAT-II
	8 424835 005764



EN 14404  
EN ISO 13688

## Rodilleras

### Kneepads

Joelheiras



EN 14404  
EN ISO 13688

**Cuerpo de PVC, neopreno y poliéster 600 Denier**  
**Relleno de espuma, gel y aire inyectado**  
**Bandas de fijación ajustables y con cierre de velcro**  
**Función antideslizante**  
**Función antimarcado**  
**Función antirayadura**  
**Función impermeable**

PVC, neoprene and 600 Denier polyester body  
 Filled with foam, gel and injected air  
 Anti-slip function  
 Anti-marking function  
 Anti-scratch function  
 Waterproof function

Corpo de PVC, neoprene e poliéster 600 Denier  
 Recheado de espuma, gel e ar injetado  
 Bandas de fixação ajustáveis com fecho de velcro  
 Função antiderrapante  
 Função anti-marcação  
 Função anti-riscos  
 Função impermeável



	<b>WK100300</b> 10 / 001-010.800
	≥ 100 N
	XL
	460 GR
	CE CAT-II
	8 424835 000332

## Rodilleras

### Kneepads

Joelheiras



EN 14404  
EN ISO 13688

**Cuerpo de PVC, neopreno y poliéster 600 Denier**  
**Relleno de espuma, gel y aire inyectado**  
**Bandas de fijación ajustables y con cierre de velcro**  
**Función antideslizante**  
**Función antimarcado**  
**Función antirayadura**  
**Función impermeable**

PVC, neoprene and 600 Denier polyester body  
 Filled with foam, gel and injected air  
 Anti-slip function  
 Anti-marking function  
 Anti-scratch function  
 Waterproof function

Corpo de PVC, neoprene e poliéster 600 Denier  
 Recheado de espuma, gel e ar injetado  
 Bandas de fixação ajustáveis com fecho de velcro  
 Função antiderrapante  
 Função anti-marcação  
 Função anti-riscos  
 Função impermeável



	<b>WK100340</b> 10 / 001-012.200
	≥ 100 N
	XL
	585 GR
	CE CAT-II
	8 424835 005757



## Traje Impermeable

### Waterproof Suit

Conjunto Impermeável

**Cuerpo de poliuretano**

**Recubrimiento de PVC**

**Refuerzos de doble costura**

**Fondo negro**

**Solapa adicional con cierre de corchete**

**Cierre con cremallera**

**Incluye 2 bolsillos y capucha**

Polyurethane body

PVC coating

Double-stitched gussets

Black background

Additional flap with rivet button closing

Zipper closing

Includes 2 pockets and hood

Corpo de poliuretano

Recobrimento de PVC

Reforços de costura dupla

Fundo preto

Lapela adicional com fechamento de colchete

Fechamento com zíper

Inclui 2 bolsos e capuz



	<b>WK102720</b> 20 / 001-019.800	<b>WK102730</b> 20 / 001-019.800	<b>WK102740</b> 20 / 001-019.800	<b>WK102750</b> 20 / 001-019.800	<b>WK102760</b> 20 / 001-019.800
	0.40MM	0.40MM	0.40MM	0.40MM	0.40MM
	S	M	L	XL	2XL
	CE CAT-I	CE CAT-I	CE CAT-I	CE CAT-I	CE CAT-I
	8 424835 006990	8 424835 007003	8 424835 007010	8 424835 007027	8 424835 007034

# Chaleco Alta Visibilidad

## High Visibility Vest

Colete Alta Visibilidade



2

EN 340

EN ISO 20471

**Cuerpo de poliéster**

**Cierre con velcro horizontal**

**Fondo amarillo fluorescente con ribete en negro**

**Transpirable**

Polyester body

Horizontal velcro closing

Yellow fluorescent background with black trim

Breathable

Corpo de poliéster

Fechamento com velcro horizontal

Fundo amarelo fluorescente com rebordo preto

Transpirável



	<b>WK101270</b> 100 / 010-001.600	<b>WK101280</b> 100 / 010-001.600	<b>WK101290</b> 100 / 010-001.600
	120 GR/M <sup>2</sup>	120 GR/M <sup>2</sup>	120 GR/M <sup>2</sup>
	XS	M	XL
	CE CAT-II	CE CAT-II	CE CAT-II
	8 424835 006259	8 424835 006266	8 424835 006273



**Gafas**  
**Glasses**  
Óculos



**Lentes de policarbonato**  
**Montura y patillas de policarbonato**  
**Sistema de ventilación**  
**Compatible con gafas graduadas**

Polycarbonate lenses  
Polycarbonate frame and side-pieces  
Ventilation system  
Compatible with prescription glasses

Lentes de policarbonato  
Armação e hastes de policarbonato  
Sistema de ventilação  
Compatível com óculos graduados



	<b>WK100820</b> 100 / 010-001.600
	F
	1
	CE CAT-II
	8 424835 004187

**Gafas**  
**Glasses**  
Óculos



**Lentes de policarbonato**  
**Montura y patillas de nylon**  
**Patillas extensibles**

Polycarbonate lenses  
Nylon frame and side-pieces  
Extendable side-pieces

Lentes de policarbonato  
Armação e hastes de nylon  
Hastes extensíveis



	<b>WK101550</b> 100 / 010-001.600
	S
	1
	CE CAT-II
	8 424835 004194

**Gafas**  
**Goggles**  
Óculos



**Lentes de policarbonato**  
**Montura de PVC**  
**Banda elástica ajustable**  
**Sistema de ventilación**  
**Compatible con gafas graduadas**

Polycarbonate lenses  
PVC frame  
Elastic adjustable band  
Ventilation system  
Compatible with prescription glasses

Lentes de policarbonato  
Armação de PVC  
Banda elástica ajustável  
Sistema de ventilação  
Compatível com óculos graduados



	<b>WK102710</b> 100 / 001-004.600
	F
	1
	CE CAT-II
	8 424835 000295

## Protector Auditivo

### Hearing Protector

Protetor Auditivo



EN 352-1

**Cuerpo de ABS composite**

**Banda de acero forjado y PVC**

**Almohadillas de espuma de microfibra y PVC**

**Banda flexible**

**Banda extensible**

**Banda plegable**

**Copas graduables**

**Peso ligero**

Composite ABS body

Forged steel and PVC band

Microfiber and PVC foam pads

Flexible band

Extendable band

Folding band

Adjustable cups

Light weight

Corpo de ABS composite

Banda de aço forjado e PVC

Almofadas de espuma de microfibra e PVC

Banda flexível

Banda extensível

Faixa dobrável

Copos ajustáveis

Peso leve



## Protector Auditivo

### Hearing Protector

Protetor Auditivo



EN 352-1

**Cuerpo de ABS composite**

**Banda de acero forjado y PVC**

**Almohadillas de espuma de microfibra y PVC**

**Banda flexible**

**Banda extensible**

**Copas graduables**

**Peso ligero**

Composite ABS body

Forged steel and PVC band

Microfiber and PVC foam pads

Flexible band

Extendable band

Adjustable cups

Light weight

Corpo de ABS composite

Banda de aço forjado e PVC

Almofadas de espuma de microfibra e PVC

Banda flexível

Banda extensível

Copos ajustáveis

Peso leve



	<b>WK101300</b> 20 / 001-005.600
	25 dB
	M
	CE CAT-III
	8 424835 005825

	<b>WK101620</b> 20 / 001-007.600
	29 dB
	M
	CE CAT-III
	8 424835 005900



**Casco**  
**Helmet**  
Capacete



EN 397

**Cuerpo de HDPE**

**Suspensión interior de poliéster de 6 puntos de anclaje**

**Ajuste del arnés mediante rosca de carraca**

**Ranuras laterales para inserción de protectores auditivos ó sistemas de visor**

**Estabilizador de rayos ultravioleta**

**Resistencia al impacto, la perforación y la llama**

**Sistema de ventilación de 6 orificios**

**Incluye banda antisudor frontal interior**

**Incluye barboquejo y mentonera**

HDPE body

Interior polyester suspension with 6 anchor points

Adjustment of the harness by ratchet thread

Lateral slots for inserting hearing protectors or visor systems

Ultraviolet ray stabilizer

Impact, puncture and flame resistance

6-hole ventilation system

Includes inner front sweatband

Includes chin strap and chin guard

Corpo de HDPE

Suspensão interior em poliéster com 6 pontos de ancoragem

Ajuste do arnés por meio de uma rosca de catraca

Slots laterais para inserir protetores auditivos ou sistemas de viseira

Estabilizador de raios ultravioleta

Resistência a impactos, perfurações e chamas

Sistema de ventilação de 6 furos

Inclui faixa de transpiração frontal interna

Inclui cinta de queixo e protetor de queixo



	<b>WK100180</b> ○	<b>WK100400</b> ●	<b>WK100410</b> ●
○ I	20 / 001-005.400	20 / 001-005.400	20 / 001-005.400
≡○	5000 N	5000 N	5000 N
🌀	≥ 10 S	≥ 10 S	≥ 10 S
🌡️	-10-50° C	-10-50° C	-10-50° C
⊘	54-63 CM	54-63 CM	54-63 CM
🗉	CE CAT-II	CE CAT-II	CE CAT-II
	8 424835 006150	8 424835 001544	8 424835 001551



**Polietileno de alta densidad con mecanismo técnico robusto. Diseño unisex y aerodinámico. Anclajes de suspensión reforzados. Equilibrio óptimo entre casco, suspensión, barbuquejo, mentonera y cabeza. Absorción de impacto de un hemisférico de 5 kilos desde 1 metro de altura, siendo la fuerza transmitida a la cabeza inferior a 5000 N. Resistencia a la penetración de un cónico de 3 kilos.**

*High-density polyethylene with robust technical mechanism. Unisex and streamlined design. Reinforced suspension anchors. Optimal balance between helmet, suspension, chin strap, chin guard and head. Impact absorption of a 5 kilo hemispherical from 1 meter high, being the force transmitted to the head less than 5000 N. Penetration resistance of a 3 kilo conical.*

*Polietileno de alta densidade com mecanismo técnico robusto. Design unissex e simplificado. Âncoras de suspensão reforçadas. Ótimo equilíbrio entre capacete, suspensão, cinta de queixo, protetor de queixo e cabeça. Absorção de impacto de um hemisférico de 5 quilos a partir de uma altura de 1 metro, sendo a força transmitida à cabeça inferior a 5000 N. Resistência à penetração de um cônico de 3 quilos.*



## Cinta Amarre Cam Buckle Strap

Fita Amarração

  
EN 12195-2

**Cuerpo de poliéster**

**Hebilla de zinc y aluminio anodizado**

**Coefficiente de seguridad de capacidad de carga de 2:1**

Polyester body

Zinc and anodized aluminium buckle







Load capacity safety coefficient of 2:1

Corpo de poliéster

Fivela de zinc e alumínio anodizado

Coefficiente de segurança de capacidade de carga 2:1



	<b>WK100510</b> 96 / 001-002.400	<b>WK100520</b> 36 / 001-005.800
	250 KG (daN)	500 KG (daN)
	3 M	4 M
	25 MM	35 MM
PCS	2	2
	TÜV GS	TÜV GS
	8 424835 003135	8 424835 002947

## Cinta Trincaje Ratchet Tie Down

Fita Amarração

  
EN 12195-2

**Cuerpo de poliéster**

**Hebilla y gancho de acero inoxidable**

**Agarre ergonómico y antideslizante**

**Coefficiente de seguridad de capacidad de carga de 2:1**

Polyester body

Stainless-steel buckle and hook

Ergonomic and non-slip grip

Load capacity safety coefficient of 2:1







Corpo de poliéster

Fivela e gancho de aço inoxidável

Agarramento ergonômico e antiderrapante

Coefficiente de segurança de capacidade de carga 2:1



	<b>WK100530</b> 54 / 001-003.200	<b>WK100540</b> 42 / 001-004.600	<b>WK100560</b> 24 / 001-006.600	<b>WK100570</b> 20 / 001-009.400	<b>WK100590</b> 10 / 001-013.400
	500 KG (daN)	1000 KG (daN)	2000 KG (daN)	3000 KG (daN)	5000 KG (daN)
	250 KG (daN)	500 KG (daN)	1000 KG (daN)	1500 KG (daN)	2500 KG (daN)
	6 M	6 M	6 M	8 M	10 M
	25 MM	25 MM	35 MM	35 MM	50 MM
	TÜV GS	TÜV GS	TÜV GS	TÜV GS	TÜV GS
	8 424835 005139	8 424835 005832	8 424835 005894	8 424835 006600	8 424835 006594

# Filtro Cubresuelo

## Floor Cover

### Filtro Cobre-Chão

Cuerpo de poliéster, algodón y polietileno

Impermeable y reutilizable

Absorbente de pinturas y líquidos

Antideslizante

Polyester, cotton and polyethylene body

Waterproof and re-usable

Paints and liquids absorbent

Anti-slip

Corpo de poliéster, algodão e polietileno

Impermeável e reutilizável

Absorvente de pinturas e líquidos

Anti-deslizante



Ø	WK102980	WK102970	WK102670
↓	24 / 001-003.000	10 / 001-005.600	6 / 001-009.600
↑	5 M	10 M	20 M
↔	1 M	1 M	1 M
∨	17 MM / 200 GR/M <sup>2</sup>	17 MM / 200 GR/M <sup>2</sup>	17 MM / 200 GR/M <sup>2</sup>
	8 424835 006037	8 424835 003425	8 424835 002770



# Químicos Técnicos

## Technical Chemicals

### Químicos Técnicos



## Transformador Óxido

### Rust Transformer

#### Transformador Óxido

**Actúa directamente contra el óxido**

**Fácil de usar, se aplica con brocha, rodillo, pistola o inmersión**

**Bajo costo, eficiencia excepcional de cobertura**

Acts directly against rust

Easy to use, to be applied by brush, roller, spray or immersion



Low cost, exceptional coverage efficiency

Age diretamente contra o óxido

Fácil de usar, é aplicado por pincel, rolo, spray ou imersão

Baixo custo, cobertura eficiência excepcional



	<b>WK200010</b> 24 / 024-004.000	<b>WK200020</b> 24 / 024-006.000	<b>WK200030</b> 12 / 012-010.000	<b>WK200040</b> 12 / 012-015.000
	125 ML	250 ML	500 ML	1000 ML
	8 424835 001254	8 424835 002503	8 424835 005009	8 424835 010003



## Transformador Óxido

### Rust Transformer

#### Transformador Óxido

**Actúa directamente contra el óxido**

**Fácil de usar, se aplica con brocha, rodillo, pistola o inmersión**

**Bajo costo, eficiencia excepcional de cobertura**

Acts directly against rust

Easy to use, to be applied by brush, roller, spray or immersion



Low cost, exceptional coverage efficiency

Age diretamente contra o óxido

Fácil de usar, é aplicado por pincel, rolo, spray ou imersão

Baixo custo, cobertura eficiência excepcional



	<b>WK200060</b> 1 / 001-060.000	<b>WK200070</b> 1 / 001-240.000
	5 L	25 L
	8 424835 000011	8 424835 000028

## Expositor y Surtido Display and Assortment

Expositor e Sortimento

Incluye 7x125 ml, 6x250 ml, 5x500 ml y 4x1000 ml  
Incluye 30 trípticos

Includes 7x125 ml, 6x250 ml, 5x500 ml and 4x1000 ml  
Includes 30 leaflets

Inclui 7x125 ml, 6x250 ml, 5x500 ml e 4x1000 ml  
Inclui 30 trípticos



○ I	<b>WK200230</b> 1 / 001-182.000
↑ ↓	325 MM
← →	390 MM
	8 424835 510008

## Expositor Display

Expositor

Incluye 30 trípticos

Includes 30 leaflets

Inclui 30 trípticos



○ I	<b>WK200080</b> 1 / 001-010.000
↑ ↓	325 MM
← →	390 MM
	8 424835 003845

## Surtido Expositor Display Assortment

Sortimento Expositor

Incluye 7x125 ml, 6x250 ml, 5x500 ml y 4x1000 ml

Includes 7x125 ml, 6x250 ml, 5x500 ml and 4x1000 ml

Inclui 7x125 ml, 6x250 ml, 5x500 ml e 4x1000 ml



○ I	<b>WK200240</b> 1 / 001-180.000
	8 424835 001612

## Trípticos Leaflets

Trípticos













































○ I	<b>WK200090</b> 1 / 001-002.000
PCS	30
	8 424835 003852







# Simbología

## Symbology

### Simbologia

	<b>Referencia</b> Item Referência		<b>Segmentos</b> Segments Segmentos		<b>Diámetro órbita</b> Orbit diameter Diâmetro órbita		<b>Certificación</b> Certification Certificação
	<b>Potencia motor</b> Motor power Potência motor		<b>Viscosidad máxima</b> Maximum viscosity Viscosidade máxima		<b>Posiciones péndulo</b> Slope positions Posições pêndulo		<b>Capas</b> Layers Camadas
	<b>Compresor necesario</b> Necessary compressor Compressor necessário		<b>Consumo aire</b> Air consumption Consumo ar		<b>Capacidad carga cinta</b> Tape load capacity Capacidade carga fita	<b>PCS</b>	<b>Unidades</b> Pieces Unidades
	<b>Airless necesario</b> Necessary airless Airless necessário		<b>Diámetro base</b> Base diameter Diâmetro base		<b>Precisión</b> Precision Precisão	<b>UV</b>	<b>Absorción ultravioleta</b> Ultraviolet absorption Absorção ultravioleta
	<b>Potencia batería</b> Battery power Potência bateria		<b>Diámetro disco</b> Disc diameter Diâmetro disco		<b>Posiciones par</b> Torque positions Posições binário		<b>Clase óptica</b> Optical class Classe ótica
	<b>Carga batería</b> Battery charge Carregamento bateria		<b>Diámetro cable</b> Cable diameter Diâmetro cabo		<b>Par máximo</b> Maximum torque Binário máximo		<b>Protección impactos</b> Impact protection Proteção impactos
	<b>Velocidades</b> Speeds Velocidades		<b>Diámetro manguera</b> Hose diameter Diâmetro mangueira		<b>Taladrado madera</b> Wood drilling Perfuração madeira		<b>Resistencia llamas</b> Flame resistance Resistência chamas
	<b>Medidas hoja</b> Blade sizes Medidas lâmina		<b>Diámetro paso fluido</b> Nozzle diameter Diâmetro passagem fluido		<b>Corte madera</b> Wood cutting Corte madeira		<b>Atenuación media</b> Mean attenuation Atenuação média
	<b>Revoluciones</b> Speed rate Rotações		<b>Diámetro corte</b> Cutting diameter Diâmetro corte		<b>Taladrado metal</b> Metal drilling Perfuração metal		<b>Potencia presión</b> Pressure power Potência pressão
	<b>Velocidad</b> Speed Velocidade		<b>Diámetro cartucho</b> Cartridge diameter Diâmetro cartucho		<b>Corte metal</b> Metal cutting Corte metal		<b>Ratio presión</b> Pressure ratio Ratio pressão
	<b>Impactos</b> Impacts Impactos		<b>Tipo punta/taco</b> Bit/stud type Tipo ponta/taco		<b>Taladrado hormigón</b> Concrete drilling Perfuração betão		<b>Medidas base</b> Base sizes Medidas base
	<b>Graduación</b> Graduation Gradação		<b>Tipo boquilla</b> Tip type Tipo boquilha		<b>Filtro partículas</b> Particles filter Filtro partículas		<b>Medidas hoja</b> Sheet sizes Medidas folha
	<b>Compatibilidad</b> Compatibility Compatibilidade		<b>Diámetro soporte</b> Support diameter Diâmetro suporte		<b>Clase</b> Class Classe		<b>Capacidad tamaño panel</b> Panel size capacity Capacidade tamanho painel
	<b>Presión succión</b> Vacuum pressure Pressão sucção		<b>Medidas cabezal</b> Head sizes Medidas cabeçal		<b>Peso</b> Weight Peso		<b>Medidas escalón</b> Step measures Medidas degrau
	<b>Presión trabajo</b> Working pressure Pressão trabalho		<b>Tomas corriente</b> Power sockets Tomadas corrente		<b>Capacidad carga</b> Load capacity Capacidade carga		<b>Medidas plataforma</b> Platform sizes Medidas plataforma
	<b>Presión máxima</b> Maximum pressure Pressão máxima		<b>Sincronización</b> Synchronisation Sincronização		<b>Límite carga en U</b> Load limit in U Limite carga em U		<b>Medidas base</b> Base sizes Medidas base
	<b>Potencia máxima</b> Maximum power Potência máxima		<b>Tipo cable</b> Cable type Tipo cabo		<b>Límite carga en línea</b> Load limit in line Limite carga em linha		<b>Medidas hoja</b> Sheet sizes Medidas folha



	<b>Temperatura</b> Temperature Temperatura		<b>Medidas</b> Sizes Medidas		<b>Diámetro clavo</b> Nail diameter Diâmetro prego		<b>Rosca entrada y salida</b> Inlet and outlet thread Rosca entrada e saída
	<b>Color temperatura</b> Temperature colour Cor temperatura		<b>Movimiento</b> Motion Movimento		<b>Largo clavo</b> Nail length Comprimento prego		<b>Rosca entrada</b> Inlet thread Rosca entrada
	<b>Temperatura trabajo</b> Working temperature Temperatura trabalho		<b>Capacidad mezclado</b> Mixing capacity Capacidade misturado		<b>Altura total</b> Total height Altura total		<b>Rosca salida</b> Outlet thread Rosca saída
	<b>Resistencia temperatura</b> Temperature resistance Resistência temperatura		<b>Grosor</b> Thickness Grossura		<b>Altura plegada</b> Folded height Altura pregada		<b>Atornillado</b> Screw Aparafusado
	<b>Ángulo haz</b> Beam angle Ângulo feixe		<b>Capacidad corte</b> Cutting capacity Capacidade corte		<b>Altura A</b> A height Altura A		<b>Capacidad</b> Capacity Capacidade
	<b>Alcance haz</b> Beam reach Escopo feixe		<b>Profundidad atornillado</b> Screw depth Profundidade aparafusado		<b>Altura andamio</b> Scaffold height Altura andaime		<b>Protección máxima</b> Maximum protection Proteção máxima
	<b>Caudal trabajo</b> Working flow Caudal trabalho		<b>Punzado metal</b> Metal punching Punçado metal		<b>Escalones</b> Steps Degraus		<b>Resistencia perforación</b> Perforation resistance Resistência perforação
	<b>Caudal máximo</b> Maximum flow Caudal máximo		<b>Ancho corte</b> Cutting width Largura corte		<b>Distancia escalones</b> Step distance Distância degraus		<b>Caudal aire</b> Air flow Caudal ar
	<b>Ancho total</b> Total width Largura total		<b>Diámetro grapa 1</b> Staple 1 diameter Diâmetro agrafa 1		<b>Número dientes</b> Teeth number Número dentes		<b>Portabrocas</b> Chuck Bucha
	<b>Ancho hoja</b> Blade width Largura lâmina		<b>Ancho grapa 1</b> Staple 1 width Largura agrafa 1		<b>Grano</b> Grain Grão		<b>Energía impacto</b> Impact energy Energia impacto
	<b>Largo total</b> Total length Comprimento total		<b>Largo grapa 1</b> Staple 1 length Comprimento agrafa 1		<b>Púas</b> Spikes Puas		<b>Talla</b> Size Tamanho
	<b>Largo hoja</b> Blade length Comprimento lâmina		<b>Diámetro grapa 2</b> Staple 2 diameter Diâmetro agrafa 2		<b>Malla</b> Mesh Malha		<b>Lumens</b> Lumens Lumens
	<b>Largo cable</b> Cable length Comprimento cabo		<b>Ancho grapa 2</b> Staple 2 width Largura agrafa 2		<b>Galga</b> Gauge Galga		<b>Duración LED</b> LED life Duração LED
	<b>Largo cartucho</b> Cartridge length Comprimento cartucho		<b>Largo grapa 2</b> Staple 2 length Comprimento agrafa 2		<b>Láminas</b> Sheets Lâminas		<b>Eficiencia energética</b> Energy efficiency Eficiência energética
	<b>Altura elevación</b> Lifting height Altura elevação		<b>Diámetro grapa 3</b> Staple 3 diameter Diâmetro agrafa 3		<b>Código barras</b> Barcode Código barras		<b>Página</b> Page Página
	<b>Altura total</b> Total height Altura total		<b>Ancho grapa 3</b> Staple 3 width Largura agrafa 3		<b>Tecnología LED</b> LED technology Tecnologia LED		
	<b>Largo cerda</b> Bristle length Comprimento cerda		<b>Largo grapa 3</b> Staple 3 length Comprimento agrafa 3		<b>Medida eje</b> Axis measurement Medida eixo		

**Observaciones**  
**Remarks**  
Observações

**Se reserva el derecho a realizar correcciones  
y/o modificaciones sin notificación previa**

**Diseñado e impreso en España  
Copyright 2024  
Werku Tools SA**

**Reserved the right to make corrections  
and/or modifications without prior notice  
Designed and printed in Spain  
Copyright 2024  
Werku Tools SA**

Se reserva o direito a realizar correções  
e/ou modificações sem notificação prévia  
Desenhado e impresso em Espanha  
Copyright 2024  
Werku Tools SA



Werku Tools SA  
Polígono Industrial de Bergondo  
Parroquia de Guísamo A8  
15165 Bergondo - La Coruña  
Spain

T +34 981 648 119  
info@werku.com  
www.werku.com



8 424835 010751