

GENWEC[®]

WASHROOM EQUIPMENT & COMP.

Catálogo *Catalog*
4.0

Genebre Group

Avinguda Joan Carles I, 46 - 48
08908 L'Hospitalet de Llobregat, Barcelona (Spain)

Almacén / Warehouse

Carrer de la Botànica, 168 - 170
08908 L'Hospitalet de Llobregat, Barcelona (Spain)
Telf: +34 93 318 31 13

Contacto comercial

Commercial Contact

Horario Comercial / Business Hours

8:30h - 13:30h / 15:00h - 18:00h

Genwec España

Genwec Spain

www.genwec.com
comercial@genwec.com
Tel: +34 93 601 80 40
Fax: +34 93 601 80 41

Genwec Exportación

Genwec Export

export@genwec.com

Otro teléfonos

Others telephone numbers

Administración

Accounting

+34 93 298 80 02

Business Whatsapp

+34 617 38 45 13



¿Deseas más información?
Do you want more information?

www.genwec.es

Síguenos / *Follow us*



En GENWEC contamos con un servicio integral de principio a fin. Diseñamos, producimos y comercializamos una amplia gama de productos para áreas y baños públicos. Controlamos todas las fases del proceso productivo para garantizar una calidad superior a las exigencias del mercado. Contamos con un gran stock para garantizar plazos de entrega inmediatos y servicio postventa personalizado. Ofrecemos un soporte de asesoramiento completo para nuestros clientes, arquitectos, ingenierías, prescriptores en general.

GENWEC pertenece al GRUPO GENE BRE. Un grupo líder en la producción y distribución de válvulas y accesorios para el control de fluidos. Con 40 años de experiencia y un equipo humano altamente cualificado formado por aproximadamente 180 personas en nuestras instalaciones de Barcelona y filiales en Europa, América y Asia, nuestro producto es comercializado en 110 países.

At GENWEC we rely on an integral service from beginning to end. We design, produce, and commercialize a big range of products intended for public and washroom areas.

We control all phases of production process to guarantee a superior quality to market requirements. We count on a large stock of finished product to be able to guarantee immediate delivery times and a personalized aftersales service. We offer a complete advice support to our customers, architects, engineering, and prescribers.

GENWEC belongs to GENE BRE GROUP. A leader group in the production and distribution of valves and accessories for fluid control. With 40 years of experience and a high qualified human team of approximately 180 persons in our headquarters in Barcelona and subsidiaries in Europe, America and Asia, our product is commercialized in 110 countries.

Soluciones para áreas públicas dirigidas al arquitecto, diseñador y promotor.

A complete solution for public areas addressed to architects, designers and developers.

Oficinas Offices

Tenemos 7 oficinas en 3 continentes.
We have 7 offices on 3 continents.

Contamos con nuestros responsables de ventas en 82 países.
We count on sales representatives in 82 countries.

Arrivals

Time	To	Flight no.	Gate	Remarks
09:10	TOKYO	EK3946	A1	ON TIME
10:50	ROME	LK3881	C3	ON TIME
11:45	MOSCOW	GB4638	C1	CANCELLED
12:45	LONDON	XV4319	A1	DELAYED
12:50	LOS ANGELES	FX5610	C4	DELAYED
12:55	SYDNEY	LE1468	B3	CANCELLED
13:00	BARCELONA	RD9932	B1	ON TIME
13:10	OSLO	FB4635	A2	ON TIME
13:35	NEW YORK	BN4267	A1	ON TIME
14:10	PARIS	GF3211	C1	DELAYED
14:50	HONOLULU	XY3190	A2	ON TIME
14:55	TORONTO	KF2317	A5	CANCELLED
15:00	ZURICH	TB7252	A4	DELAYED
15:30	HONG KONG	FK3323	B4	ON TIME
15:35	FRANKFURT	BF1434	B3	DELAYED
15:40	MIAMI	ER2753	A1	ON TIME

EM PRE SA

Company

Departures				
Time	To	Flight no.	Gate	Remarks
09:35	NEW YORK	DF2753	A1	ON TIME
09:40	FRANKFURT	LN3211	C3	ON TIME
09:45	TORONTO	GT4638	A2	ON TIME
09:45	LONDON	KV3323	B4	DELAYED
09:50	MIAMI	LX3100	A2	DELAYED
09:55	SYDNEY	LV2317	A5	ON TIME
10:00	PARIS	BD9032	B1	ON TIME
10:00	OSLO	FS5610	C4	ON TIME
10:05	HONG KONG	EN4267	A4	DELAYED
10:10	BARCELONA	GC5433	C1	ON TIME
10:15	TOKYO	LY4488	B2	ON TIME
10:20	MOSCOW	KF3280	B4	CANCELLED
10:25	ZÜRICH	TK7252	A4	ON TIME
10:30	LOS ANGELES	TK3946	A1	ON TIME
10:35	ROME	RZ1405	B3	DELAYED
10:40	HONOLULU	EK4319	A1	ON TIME



¿Deseas más información?
Do you want more information?



CA LI DAD

Quality

Tecnología de vanguardia con corazón.
Leading edge technology from the heart.



¿Deseas más información?
Do you want more information?





La calidad, el compromiso con la sociedad y el cuidado medioambiental está presente en toda nuestra cadena de valor. Esta nos permite crear conceptos innovadores que generen un impacto positivo en el medio ambiente y a la vez satisfacen las necesidades de los clientes en funcionalidad, confort y diseño.

Nuestro sistema de control de la calidad está certificado de acuerdo a la norma UNE-EN-ISO 9001, por parte del prestigioso organismo certificador Independent European Certification Ltd. y revisado anualmente. Además, para nuestros modelos de secamanos disponemos de certificaciones acordes a las mayores exigencias requeridas por el mercado.

Quality, commitment to society and environmental awareness is present in our entire value chain.

This vision, allows us to create innovative concepts that generate a positive impact on the environment and at the same time satisfy the clients' needs for functionality, comfort and design.

Our quality management system is certified according to the UNE-EN-ISO 9001 standard, by the prestigious Independent European Certification Ltd. and reviewed annually. In addition to our models of dryers, we have certifications according to the market requirements.

PROYECTOS

Projects



Airports

- Madrid Barajas Airport, Madrid (Spain)
- Josep Tarradellas Airport, Barcelona (Spain)
- La Coruña Airport, A Coruña (Spain)
- Umberto Delgado Airport, Lisboa (Portugal)



Business Center

- Skycity Business Center, Mérida (Mexico)
- Centro Inter. de Congresos, Merida (Mexico)
- Centris Iasi, Iasi (Romania)
- Telus Tower, Sofia (Bulgaria)



Malls/Shopping Centers

- Lavina Shopping Center, Kyiv (The Mall)
- The Mall Shopping Complex, Doha (Qatar)
- Dubai Hills Mall, Dubai (UAE)
- C.C. Torrecardenas, Almería (Spain)



Hospitals

- Banco de Seguros, Montevideo (Uruguay)
- King's College Hospital, Dubai, (UAE)
- Hospital Provincial de Zamora, Zamora (Spain)
- Hospital IMED Valencia, Valencia (Spain)



The author:
Marie-Françoise Valéry studied English and political science and landscape gardening, an area in which she is a recognized expert. She has written a number of gardening books on various topics, as well as articles for various garden and design magazines.

The editor:
Angelika Taschen studied art history and German literature and received her doctorate in 1986. Working for TASCHEN from 1987 to 1991, she has written numerous titles on art, architecture, photography, design, and fashion.

Residential Architecture
PRODOMITOH1
IK

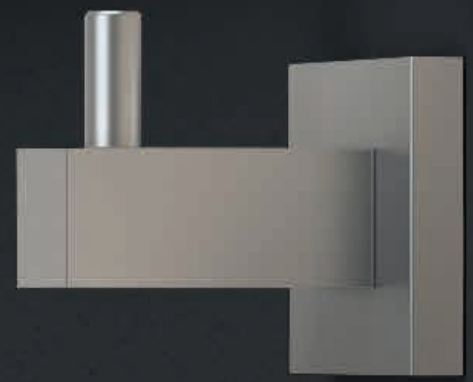

Stadiums

- Dagály Aquatics Complex, Budapest (Hungary)
- Gran Parque Central, Montevideo (Uruguay)
- Puskás Arena, Budapest (Hungary)
- Estadio Municipal de Ipurua, Eibar (Spain)



Hotels

- Grand Sirenis Riviera Maya Resort & Spa, Riviera Maya (Mexico)
- Hotel Four Seasons, Madrid (Spain)
- Movenpick Hotel, Riyadh (Saudi Arabia)
- Eden Beach Resort, Anavyssos (Greece)



Offices/Headquarters

- Opel Szentgotthárd factory, Szentgotthárd, (Hungary)
- Oficinas Centrales ILUNION, Madrid (Spain)
- Amazon warehouse, Illescas (Spain)
- Road & Transport Authority, Dubai (UAE)



Educational Centers

- Campus de Carcavelos, Lisboa (Portugal)
- Facultat de Dret, Barcelona (Spain)
- Universidad de Segovia, Segovia (Spain)
- New Heaven High School, Antofagasta (Chile)



Others

- McDonalds Restaurants, across Europe
- Cactus Supermarche, across Luxembourg
- Primark Arese Shopping Center, Arese (Italy)
- Mercadona Supermarkets chain, across (Spain)
- Tabernas Volapie, across Spain

NO VE DA DES

News

Accesorios para baños *Washroom accessories*

NEW

Descubre la nueva serie de accesorios para espacios de baño Nimbus y los nuevos acabados Brushed Metal y Gold, máxima versatilidad y diseño para la decoración de interiores.

Discover the new series of accessories for bathroom spaces Nimbus and the new Brushed Metal and Gold finishes, maximum versatility and design for interior decoration.



<https://www.genwec.es/accesorios-de-bano>

NEW

Secamanos *Hand Dryers*

FALCON

Altas prestaciones y máxima higiene
High efficiency hygienic hand dryer

Diseñado en Barcelona, el secamanos FALCON representa la máxima innovación en el mundo del secado de manos. Con un secado rápido y energéticamente eficiente, FALCON garantiza un aire totalmente limpio gracias a su triple tecnología higienizante.

Engineered in Barcelona, the FALCON hand dryer is the latest innovation on the hand drying industry. With a fast & efficient drying experience, FALCON ensures a clean & purified air thanks to its triple sanitizing technology.

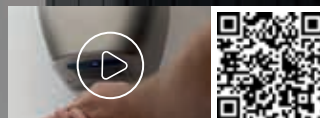

Reproducir vídeo
Play video



Ver ficha técnica
See technical sheet

Ayudas técnicas a la movilidad
Grab bars & technical mobility supports

NEW

Descubre las nuevas soluciones Genwec en ayudas técnicas para espacios de baño, pensadas y diseñadas para salvar las barreras que una persona con discapacidad o movilidad reducida y pueda encontrar.

Discover the new Genwec solutions in technical aids for bathroom spaces, designed and designed to overcome the barriers that a person with a disability or reduced mobility may encounter.



<https://www.genwec.es/ayudas-tecnicas>

Índice por referencia / Index by reference



Secamanos *Hand dryers*

REF: GW01	P:
GW01 02 02 00	21
GW01 02 02 03	21
GW01 02 04 01	21
GW01 02 04 02	21
GW01 03 02 00	22
GW01 03 02 03	22
GW01 03 04 01	22
GW01 03 04 02	22
GW01 04 02 00	23
GW01 04 02 02	23
GW01 04 04 01	23
GW01 04 02 03	23
GW01 12 02 00	28
GW01 12 02 00V1	28
GW01 12 02 01	28
GW01 12 02 01V1	28
GW01 12 02 04	28
GW01 12 02 04V1	28
GW01 14 01 00	31
GW01 14 01 00V1	31
GW01 14 03 00	31
GW01 14 03 00V1	31
GW01 14 04 01	31
GW01 14 04 01V1	31
GW01 14 04 02	31
GW01 15 01 00	25
GW01 15 01 04	25
GW01 15 01 04V1	25
GW01 16 01 00	24
GW01 16 01 04	24
GW01 17 01 00	30
GW01 17 01 03	30
GW01 17 04 01	30
GW01 17 04 02	30
GW01 17 04 03	30
GW01 18 04 00	26
GW01 18 04 01	26
GW01 18 04 03	26

GW01 21 04 01	27
GW01 21 04 03	27
GW01 25 03 00	29
GW01 25 04 01	29
GW01 25 04 02	29
GW01 26 03 00	29
GW01 26 04 01	29
GW01 26 04 02	29
GW01 28 02 00	20
GW01 28 02 03	20
GW01 28 04 01	20
GW01 28 04 02	20
GW01 40 04 00	19
GW01 40 04 01	19
GW01 40 04 03	19
GW01 90 01 03	32



Secadores de pelo *Hair dryers*

REF: GW02	P:
GW02 01 01 00	39
GW02 02 01 00	40
GW02 03 01 00	41
GW02 03 01 00V1	41
GW02 03 01 03	41
GW02 08 01 00	42
GW02 08 01 00B	42
GW02 08 01 03	42
GW02 08 01 03B	42



Dispensadores de papel *Paper dispensers*

REF: GW03	P:
GW03 02 04 01	47
GW03 02 04 02	47

GW03 02 04 03	47
GW03 04 04 01	47
GW03 04 04 02	47
GW03 04 04 03	47
GW03 05 04 01	48
GW03 05 04 02	48
GW03 05 04 03	48
GW03 08 04 01	50
GW03 08 04 02	50
GW03 09 04 02	51
GW03 10 04 02	50
GW03 10 04 01	50
GW03 11 04 02	51
GW03 12 04 01	50
GW03 13 04 01	50
GW03 14 03 00	51
GW03 14 04 01	51
GW03 14 04 02	51
GW03 15 04 01	52
GW03 18 01 00	53
GW03 18 01 04	53
GW03 19 01 00	54
GW03 19 01 04	54
GW03 20 01 00	53
GW03 20 01 04	53
GW03 21 01 00	54
GW03 21 01 04	54
GW03 24 04 01	48
GW03 25 04 01	52
GW03 25 04 02	52
GW03 27 04 01	49
GW03 28 04 01	49
GW03 29 04 01	49



Dosificadores de jabón *Soap dispensers*

REF: GW04	P:
GW04 01 04 01	59
GW04 01 04 01B	59
GW04 01 04 02	59
GW04 01 04 02B	59

GW04 01 04 03B	59
GW04 02 04 01	60
GW04 02 04 02	60
GW04 06 04 01	62
GW04 06 04 02	62
GW04 08 01 00	64
GW04 09 01 00	63
GW04 10 01 00	63
GW04 10 01 00B	63
GW04 12 01 00	65
GW04 12 01 04	65
GW04 13 01 00	65
GW04 13 01 04	65
GW04 14 01 00	65
GW04 14 01 04	65
GW04 15 01 00	66
GW04 15 04 02	62
GW04 16 01 00	66
GW04 16 01 03	66
GW04 16 01 04	66
GW04 16 04 01	60
GW04 16 04 03	60
GW04 17 01 00	64
GW04 20 04 01	61
GW04 20 04 02	61
GW04 21 04 01	61
GW04 21 04 03	61



Accesorios de baño *Washroom accessories*

REF: GW05	P:
GW05 01 04 01	75
GW05 01 04 01B	75
GW05 01 05 02	71
GW05 01 05 02B	71
GW05 01 06 02	87
GW05 02 04 01	75
GW05 02 05 02	71
GW05 02 06 02	87
GW05 03 04 01	75
GW05 03 05 02	71

GW05 03 06 02	87	GW05 20 06 02	90	GW05 55 04 03	85	GW05 78 04 03	80
GW05 04 04 01	75	GW05 21 04 01	78	GW05 56 04 03	85	GW05 78 04 07	84
GW05 04 05 02	71	GW05 21 06 02	90	GW05 57 04 03	85	GW05 78 04 09	82
GW05 04 06 02	87	GW05 22 04 01	78	GW05 58 04 03	85	GW05 79 04 03	80
GW05 05 04 01	75	GW05 22 06 02	92	GW05 59 04 03	85	GW05 79 04 07	84
GW05 05 05 02	71	GW05 23 04 01	78	GW05 60 04 03	85	GW05 79 04 09	82
GW05 05 06 02	87	GW05 23 06 02	92	GW05 61 04 03	85	GW05 80 04 03	80
GW05 06 04 01	75	GW05 24 04 01	78	GW05 62 04 03	86	GW05 80 04 03B	80
GW05 06 05 02	71	GW05 24 06 02	93	GW05 63 04 03	86	GW05 80 04 07	84
GW05 06 06 02	88	GW05 25 04 01	76	GW05 64 04 03	86	GW05 80 04 07B	84
GW05 07 04 01	76	GW05 25 04 02	93	GW05 65 04 03	86	GW05 80 04 09	82
GW05 07 05 02	72	GW05 26 06 02	93	GW05 66 04 03	86	GW05 80 04 09B	82
GW05 07 06 02	87	GW05 27 04 02	93	GW05 67 04 03	86	GW05 81 04 03	80
GW05 08 04 01	76	GW05 28 04 02	94	GW05 68 05 02	91	GW05 81 04 07	84
GW05 08 05 02	72	GW05 28 06 02	87	GW05 69 04 01	91	GW05 81 04 09	82
GW05 08 06 02	88	GW05 29 04 02	94	GW05 70 04 03	79	GW05 82 04 01	91
GW05 09 04 01	76	GW05 30 06 02	96	GW05 70 04 03B	79	GW05 82 04 01B	91
GW05 09 04 01B	76	GW05 30 06 03	96	GW05 70 04 07	83	GW05 82 04 02	91
GW05 09 05 02	72	GW05 31 06 02	96	GW05 70 04 07B	83	GW05 82 04 02B	91
GW05 09 06 02	88	GW05 31 06 03	96	GW05 70 04 09	81	GW05 83 04 02	93
GW05 10 04 01	76	GW05 32 04 02	95	GW05 70 04 09B	81	GW05 84 04 02	92
GW05 10 05 02	72	GW05 33 05 01	95	GW05 71 04 03	79	GW05 84 04 02B	92
GW05 10 06 02	88	GW05 34 04 02	92	GW05 71 04 07	83		
GW05 11 04 01	76	GW05 35 04 02	92	GW05 71 04 09	81		
GW05 11 05 02	72	GW05 37 04 02	94	GW05 72 04 03	79		
GW05 11 05 02B	72	GW05 38 04 01	94	GW05 72 04 07	83		
GW05 11 06 02	88	GW05 38 04 03	94	GW05 72 04 09	81		
GW05 12 04 01	76	GW05 38 06 02	96	GW05 73 04 01	94		
GW05 12 05 02	72	GW05 39 06 02	96	GW05 73 04 03	79		
GW05 12 06 02	89	GW05 40 04 02	73	GW05 73 04 07	83		
GW05 13 04 01	77	GW05 40 04 02B	73	GW05 73 04 09	81		
GW05 13 04 01B	77	GW05 41 04 02	73	GW05 74 04 01	95		
GW05 13 05 02	72	GW05 42 04 02	73	GW05 74 04 03	79		
GW05 13 06 02	89	GW05 43 04 02	73	GW05 74 04 07	83		
GW05 14 04 01	77	GW05 44 04 02	73	GW05 74 04 09	81		
GW05 14 06 02	89	GW05 45 04 02	73	GW05 75 04 03	79		
GW05 15 04 01	77	GW05 46 04 02	74	GW05 75 04 07	83		
GW05 15 06 02	89	GW05 47 04 02	74	GW05 75 04 09	81		
GW05 16 04 01	77	GW05 48 04 02	74	GW05 76 04 03	80		
GW05 16 06 02	90	GW05 49 04 02	74	GW05 76 04 03B	80		
GW05 17 04 01	77	GW05 49 04 02B	74	GW05 76 04 07	84		
GW05 17 06 02	89	GW05 50 04 02	74	GW05 76 04 07B	84		
GW05 18 04 01	77	GW05 51 04 02	74	GW05 76 04 09	82		
GW05 18 06 02	90	GW05 52 04 02	74	GW05 76 04 09B	82		
GW05 19 04 01	78	GW05 53 04 02	93	GW05 77 04 03	80		
GW05 19 06 02	90	GW05 54 04 02	93	GW05 77 04 07	84		
GW05 20 04 01	78	GW05 54 06 02	96	GW05 77 04 09	82		



Papeleras *Wastepaper bins*

REF: GW06	P.:
GW06 01 04 01	101
GW06 02 04 01	101
GW06 02 04 01T1	101
GW06 02 03 03	101
GW06 02 04 02	101
GW06 03 03 03	101
GW06 03 04 01	101
GW06 03 04 02	101
GW06 04 04 01	101
GW06 04 04 02	101
GW06 06 04 01	102
GW06 07 04 01	102
GW06 10 04 02	103
GW06 12 02 01	103
GW06 13 04 01	104
GW06 14 04 01	104
GW06 14 04 03	104
GW06 15 04 01	105
GW06 15 04 03	105
GW06 16 02 01	107
GW06 17 02 01	107
GW06 17 04 01	105
GW06 18 02 01	108
GW06 18 04 01	104
GW06 19 04 01	107
GW06 20 04 01	109
GW06 24 04 01	102
GW06 25 04 01	106
GW06 27 02 01	108
GW06 26 04 01	106
GW06 28 04 01	109
GW06 37 04 02	106
GW06 37 04 02T	106



Cambiapañales *Baby changing stations*

REF: GW07	P.:
GW07 02 01 00	113
GW07 03 04 02	114
GW07 04 04 02	114
GW07 05 01 00	113
GW07 05 04 01	113
GW07 06 01 00	115



Sanitarios acero inoxidable *Stainless steel sanitary products*

REF: GW08	P.:
GW08 11 04 02	119
GW08 12 04 02	119
GW08 13 04 02	119
GW08 14 04 02	119
GW08 15 04 02	119
GW08 16 04 02	119
GW08 17 04 02	119
GW08 18 04 02	119
GW08 19 04 02	119
GW08 20 04 02	119
GW08 21 04 02	119
GW08 22 04 02	119
GW08 23 06 02	120
GW08 24 06 02	120
GW08 25 04 01	120
GW08 26 04 01	121
GW08 27 04 01	120
GW08 35 04 01	123
GW08 36 04 01	123
GW08 37 04 01	123
GW08 38 04 01	123
GW08 39 04 01	123
GW08 40 04 01	123

GW08 41 04 01	123
GW08 42 04 01	123
GW08 43 04 01	123
GW08 44 04 01	123
GW08 45 04 01	123
GW08 46 04 01	123
GW08 47 04 01	124
GW08 48 04 01	124
GW08 49 04 01	124
GW08 50 04 01	125
GW08 51 04 01	125
GW08 52 04 01	125
GW08 53 04 01	122
GW08 54 04 01	122
GW08 55 04 01	126
GW08 56 04 01	126
GW08 57 04 01	126
GW08 58 04 01	126
GW08 59 04 01	127
GW08 60 04 01	127
GW08 61 04 01	127
GW08 62 04 01	128
GW08 63 04 01	128
GW08 64 04 01	128
GW08 68 04 01	129
GW08 69 04 01	129
GW08 70 01 00	126
GW08 70 04 01	129
GW08 71 04 01	129
GW08 72 04 01	121
GW08 73 04 01	129
GW08 74 04 01	129
GW08 75 04 01	129
GW08 84 04 01	125
GW08 86 04 01	127
GW08 90 04 01	128



Muebles compactos *Compact furniture*

REF: GW09	P.:
GW09 01 04 01	133
GW09 02 04 01	134
GW09 02 04 01FL	134
GW09 02 04 01H1	134

GW09 03 04 01	135
GW09 07 04 01	133
GW09 08 04 01	134
GW09 09 04 01	135
GW09 11 04 01	135
GW09 12 04 01	135
GW09 13 04 01	135
GW09 14 04 01	136
GW09 15 04 01	136



Fuentes de agua *Water dispensers*

REF: GW10	P.:
GW10 01 04 02	142
GW10 01 90 00	146
GW10 01 90 01	146
GW10 02 04 02	143
GW10 03 04 02	144
GW10 04 04 02	145
GW10 06 01 00	146
GW10 06 04 02	141
GW10 07 01 00	146
GW10 08 01 00	146
GW10 14 04 02	144



Ayudas técnicas a la movilidad *Grab bars & technical mobility supports*

REF: GW11	P.:
GW11 01 03 00	151
GW11 01 04 01	151
GW11 01 04 02	151
GW11 01 90 00	158
GW11 01 90 01	158
GW11 01 90 02	158
GW11 01 90 03	158
GW11 02 03 00	151

GW11 02 04 01	151
GW11 02 04 02	151
GW11 02 04 03	151
GW11 03 03 00	151
GW11 03 04 01	151
GW11 03 04 02	151
GW11 03 04 03	151
GW11 04 03 00	151
GW11 04 04 01	151
GW11 04 04 02	151
GW11 04 04 03	151
GW11 05 03 00	151
GW11 05 04 01	151
GW11 05 04 02	151
GW11 06 03 00	151
GW11 06 04 01	151
GW11 06 04 02	151
GW11 07 03 00	152
GW11 07 04 01	152
GW11 07 04 02	152
GW11 07 04 03	152
GW11 08 03 00	152
GW11 08 04 01	152
GW11 08 04 02	152
GW11 09 03 00	153
GW11 09 04 01	153
GW11 09 04 02	153
GW11 10 01 01	158
GW11 10 01 02	158
GW11 10 03 00	154
GW11 10 04 01	154
GW11 10 04 02	154
GW11 11 03 00	154
GW11 11 04 01	154
GW11 11 04 02	154
GW11 12 03 00	154
GW11 12 04 01	154
GW11 12 04 02	154
GW11 13 03 00	154
GW11 13 04 01	154
GW11 13 04 02	154
GW11 14 03 00	155
GW11 14 04 01	155
GW11 14 04 02	155
GW11 15 03 00	156
GW11 15 04 01	156
GW11 15 04 02	156
GW11 16 03 00	156
GW11 16 04 01	156
GW11 16 04 02	156

GW11 17 03 00	156
GW11 17 04 01	156
GW11 17 04 02	156
GW11 18 03 00	157
GW11 18 04 01	157
GW11 18 04 02	157
GW11 20 03 00	157
GW11 20 04 01	157
GW11 20 04 02	157
GW11 21 03 00	157
GW11 21 04 01	157
GW11 21 04 02	157
GW11 22 03 00	155
GW11 22 04 01	155
GW11 22 04 02	155
GW11 23 03 00	158
GW11 23 04 01	158
GW11 23 11 00	158
GW11 24 03 00	159
GW11 24 04 01	159
GW11 24 11 00	159
GW11 26 09 00	160
GW11 27 04 01	153
GW11 27 09 00	160
GW11 28 01 00	159
GW11 28 01 03	159
GW11 28 09 00	160
GW11 29 09 00	160
GW11 30 09 00	160
GW11 31 09 00	160
GW11 32 09 00	160
GW11 33 09 00	161
GW11 34 09 00	161
GW11 35 09 00	161
GW11 36 09 00	161
GW11 37 09 00	163
GW11 38 09 00	162
GW11 39 09 00	162
GW11 40 09 00	162
GW11 41 09 00	163
GW11 42 07 00	165
GW11 43 07 00	165
GW11 44 07 00	165
GW11 47 01 00	166
GW11 49 07 00	164
GW11 50 03 00	164
GW11 51 03 00	164
GW11 52 03 00	164
GW11 53 01 00	164
GW11 54 06 02	164

GW11 58 12 00	166
GW11 59 12 00	166
GW11 60 03 00	153
GW11 60 04 01	153
GW11 61 09 00	162
GW11 62 09 00	161
GW11 63 01 00	166
GW11 64 01 00	165
GW11 65 06 02	166
GW11 66 02 00	163
GW11 69 04 01	163
GW11 70 04 01	163
GW11 71 04 01	163
GW11 72 04 01	163
GW11 73 03 00	152
GW11 73 04 01	152
GW11 77 04 01	165



Lavaojos y duchas de emergencia
Eye washers & emergency showers

REF.: GW12	P.:
GW12 01 03 05	171
GW12 01 04 05	171
GW12 02 03 05	171
GW12 02 04 05	171
GW12 03 03 05	171
GW12 03 04 05	171
GW12 04 03 05	172
GW12 04 04 05	172
GW12 05 03 05	172
GW12 05 04 05	172



Grifería y soluciones integradas
Taps & behind mirror solutions

REF.: GW13	P.:
GW13 01 06 02	182
GW13 02 06 02	183
GW13 03 06 02	182
GW13 04 06 02	183
GW13 05 06 02	183
GW13 06 06 02	186
GW13 07 06 02	186
GW13 08 06 02	186
GW13 09 06 02	184
GW13 10 06 02	179
GW13 11 06 02	179
GW13 12 06 02	180
GW13 13 06 02	185
GW13 14 06 02	185
GW13 15 06 02	184
GW13 16 06 02	177
GW13 16 06 03	177
GW13 17 06 02	177
GW13 17 06 03	177
GW13 19 06 02	181
GW13 20 04 01	181
GW13 20 06 02	180
GW13 21 06 02	178
GW13 21 06 03	178
GW13 22 06 02	178
GW13 22 06 03	178



Baño de hotel *Hotel bathroom*





Ref. GW01 40 04 01 (pág. 19)

Customizable Flexible

Carcasas en blanco, satinado o negro
White, Satin or Black casing

Ajustable Flexible

Motor ajustable a 3 velocidades distintas
Adjustable three speed motor controls

Ajuste velocidad de secado,
nivel de sonido y ahorro energético
*Customize drying time, sound level
and energy savings*

Higiénico Hygienic

Filtro HEPA H14 intercambiable
Replaceable HEPA H14 filter

Luz UVC
UVC light

Generador de iones
Ion generator

Resistente y antivandálico Durable and vandal resistant

Carcasa de acero inoxidable
de 1,5mm de espesor
1.5mm thickness stainless steel cover

Tornillos a prueba de manipulaciones
Tamper-proof screws

Duración del motor 3 veces superior a
modelos similares de la competencia
*Motor lasts up to 3 times longer than the
competition*

Rating IP24 - Protección contra el agua
y objetos sólidos
*IP24 rating - protection against harmful
water & solid objects ingress*

Secamanos *Hand dryers*

Características destacadas
Features



Filtro de alta eficiencia
Elimina el 99,97% de las partículas >0,3µ
High Efficiency Particulate Air
Captures 99,97% of particles >0,3µ



Automático
Automatic

Altamente eficiente *Highly efficient*

12" para un secado completo
12" drying time

Sólo 950W en velocidad máxima
950W total power at maximum speed



Silenciosa *Silent*



Ref. GW01 40 04 03 (pág. 19)



Certificaciones *Certification*

CB test certificate & G-Mark por laboratorios externos
CB test certificate & G-Mark issued by external laboratories



Más sobre la actualidad de secamanos.
More about current hand dryers.



NEW

Ref. GW01 40 04 01
 1,5 mm acero inoxidable
 1.5 mm stainless steel
 Satinado *Brushed*

NEW

Ref. GW01 40 04 00
 1,5 mm acero inoxidable
 1.5 mm stainless steel
 Blanco *White*

NEW

Ref. GW01 40 04 03
 1,5 mm acero inoxidable
 1.5 mm stainless steel
 Negro mate *Matt black*



Secamanos *Hand dryer*

Falcon

Automático	<i>Sensor operated</i>
Energéticamente eficiente	<i>Highly energy efficient</i>
Triple tecnología higienizante	<i>Triple sanitizing technology</i>
Filtro HEPA H14 incluido	<i>HEPA H14 filter included</i>
Ajustable 3 velocidades	<i>3 speed motor settings</i>
Escobillas de larga duración	<i>Longest brush life</i>
Medidas 320 x 205 x 135 mm	<i>Measurements 320 x 205 x 135 mm</i>

Características técnicas *Technical features*



Voltaje <i>Voltage</i>	220 - 240 V	Aislamiento eléctrico <i>Electrical insulation</i>	Class I
Frecuencia <i>Frequency</i>	50 / 60 Hz	Protección <i>Protection level</i>	IP24
Velocidad aire <i>Air speed</i>	245 - 400 Km/h	Peso <i>Weight</i>	5 Kg
Caudal aire <i>Airflow</i>	64 - 103 m³/h	Tiempo de secado <i>Drying time</i>	12"
Temperatura aire <i>Air temperature</i>	45 - 51 °C	Sonoridad a 2 m <i>Sound level at 2 m</i>	69 - 74 dBA
Potencia total <i>Total power</i>	230 / 900 W	rpm <i>rpm</i>	19.000 - 31.000
Potencia resistencia <i>Power of heating element</i>	400 W	Desconexión anti vandálica <i>Automatic shut-off</i>	30"
Potencia motor <i>Motor power</i>	230 / 500W	Garantía (años) <i>Warranty (years)</i>	5
Consumo <i>Power consumption</i>	1,0 - 3,9 A		

Ref. GW01 28 02 00
3 mm aluminio 3 mm aluminium
Epoxi blanco White epoxy

Ref. GW01 28 04 02
2mm acero inoxidable
2 mm stainless steel
Brillante Polished chrome

Ref. GW01 28 02 03
3mm aluminio 3 mm aluminium
Negro Black



Ref. GW01 28 04 01
2 mm acero inoxidable
2 mm stainless steel
Satinado Brushed chrome

Secamanos Hand dryer

Verdedri

Automático	Sensor operated
Energéticamente eficiente	Highly energy efficient
Recomendado en áreas de tráfico alto	Recommended on high traffic zones
Ajustable 3 velocidades	3 speed motor settings
Filtro HEPA incluido	HEPA Filtration included
Adaptado a normativa ADA	ADA compliant
Tratamiento antibacteriano STERITOUCH	STERITOUCH anti-bacterial treatment
Escobillas de larga duración	Longest brush life
Tornillería antivandálica	Vandal-proof screws
Medidas 368 x 311 x 100 mm	Measurements 368 x 311 x 100 mm

Características técnicas Technical features



Voltaje Voltage	120 - 277 V	Aislamiento eléctrico Electrical insulation	Class I
Frecuencia Frequency	50 / 60 Hz	Protección Protection level	IP24
Velocidad aire Air speed	241 - 362 Km/h	Peso Weight	5,5 Kg
Caudal aire Airflow	71 - 109 m³/h	Tiempo de secado Drying time	12"
Temperatura aire Air temperature	55°C	Sonoridad a 2 m Sound level at 2 m	69 dBA
Potencia total Total power	675 / 950 W	rpm rpm	26.000 - 31.000
Potencia resistencia Power of heating element	475 W	Desconexión anti vandálica Automatic shut-off	30"
Potencia motor Motor power	200 / 475 W	Garantía (años) Warranty (years)	5
Consumo Power consumption	4,1 - 8,3 A		

Ref. GW01 02 04 02
 2mm acero inoxidable
2 mm stainless steel
 Brillante *Polished chrome*



Ref. GW01 02 02 00
 3 mm aluminio inyectado
3 mm injected aluminium
 Epoxi blanco *White epoxy*



Ref. GW01 02 04 01
 2 mm acero inoxidable
2 mm stainless steel
 Satinado *Brushed chrome*



Ref. GW01 02 02 03
 3 mm aluminio inyectado
3 mm injected aluminium
 Negro *Black*

Secamanos *Hand dryer*

SMARTdri Plus

Automático	<i>Sensor operated</i>
Altamente eficiente	<i>Highly energy efficient</i>
Secado muy rápido	<i>Fast drying time</i>
3 modalidades potencia	<i>3 speed motor settings</i>
Resistencia ON / OFF	<i>ON / OFF heating element</i>
Tratamiento antibacteriano STERITOUCH	<i>STERITOUCH anti-bacterial treatment</i>
Escobillas de larga duración	<i>Longest brush life</i>
Filtro incluido	<i>Filter included</i>
Tornillería antivandálica	<i>Vandal-proof screws</i>
Medidas 319 x 236 x 192 mm	<i>Measurements 319 x 236 x 192 mm</i>

Características técnicas *Technical features*



Voltaje <i>Voltage</i>	220 - 240 V	Aislamiento eléctrico <i>Electrical insulation</i>	Class I
Frecuencia <i>Frequency</i>	50 / 60 Hz	Protección <i>Protection level</i>	IP24
Velocidad aire <i>Air speed</i>	200 - 400 Km/h	Peso <i>Weight</i>	5,1 kg
Caudal aire <i>Airflow</i>	65 - 130 m3/h	Tiempo de secado <i>Drying time</i>	10"
Temperatura aire <i>Air temperature</i>	53 °C	Sonoridad a 2 m <i>Sound level at 2 m</i>	69 / 77 dBA
Potencia total <i>Total power</i>	400 / 1.200 W	rpm <i>rpm</i>	23.400
Potencia resistencia <i>Power of heating element</i>	400 W	Desconexión anti vandálica <i>Automatic shut-off</i>	30"
Potencia motor <i>Motor power</i>	400 / 800 W	Garantía (años) <i>Warranty (years)</i>	5
Consumo <i>Power consumption</i>	1,7 - 5,2 A		

Ref. GW01 03 02 00
 3 mm aluminio inyectado
 3 mm injected aluminium
 Epoxi blanco White epoxy



Ref. GW01 03 04 01
 2 mm acero inoxidable
 2 mm stainless steel
 Satinado Brushed



Ref. GW01 03 04 02
 2 mm acero inoxidable
 2 mm stainless steel
 Brillante Polished



Ref. GW01 03 02 03
 3 mm aluminio inyectado
 3 mm injected aluminium
 Negro Black

Secamanos Hand dryer **SLIMdri**

Automático	<i>Sensor operated</i>
Altamente eficiente	<i>Highly energy efficient</i>
Secado muy rápido	<i>Fast drying time</i>
Adaptado a normativa ADA	<i>ADA compliant</i>
Resistencia ON / OFF	<i>ON / OFF heating element</i>
Tratamiento antibacteriano STERITOUCH	<i>STERITOUCH anti-bacterial treatment</i>
Diseño moderno y ultracompacto	<i>Ultra compact and Modern design</i>
Tornillería antivandálica	<i>Vandal-proof screws</i>
Medidas 271 x 290 x 100 mm	<i>Measurements 271 x 290 x 100 mm</i>

Características técnicas *Technical features*



Voltaje <i>Voltage</i>	220 - 240 V	Aislamiento eléctrico <i>Electrical insulation</i>	Class I
Frecuencia <i>Frequency</i>	50 / 60 Hz	Protección <i>Protection level</i>	IP23
Velocidad aire <i>Air speed</i>	226 km/h	Peso <i>Weight</i>	4,8 kg
Caudal aire <i>Airflow</i>	119 m³/h	Tiempo de secado <i>Drying time</i>	15"
Temperatura aire <i>Air temperature</i>	48 °C	Sonoridad a 2 m <i>Sound level at 2 m</i>	72 dBA
Potencia total <i>Total power</i>	335 / 950 W	rpm <i>rpm</i>	13.000
Potencia resistencia <i>Power of heating element</i>	615 W	Desconexión anti vandálica <i>Automatic shut-off</i>	60"
Potencia motor <i>Motor power</i>	335 W	Garantía (años) <i>Warranty (years)</i>	5
Consumo <i>Power consumption</i>	4,1 A		

Ref. GW01 04 04 01
 2 mm acero inoxidable
 2 mm stainless steel
 Satinado *Brushed*



Ref. GW01 04 02 00
 3 mm aluminio inyectado
 3 mm injected aluminium
 Epoxi blanco *White epoxy*



Ref. GW01 04 02 02
 3 mm aluminio inyectado
 3 mm injected aluminium
 Brillante *Polished chrome*



Ref. GW01 04 02 03
 3 mm aluminio inyectado
 3 mm injected aluminium
 Negro *Black*

Secamanos *Hand dryer* **AIRforce**

Automático	<i>Sensor operated</i>
Altamente eficiente	<i>Highly energy efficient</i>
Secado muy rápido	<i>Fast drying time</i>
Sin resistencia eléctrica	<i>Without heating element</i>
Salida de aire eficiente	<i>Innovative multi-port diffuser nozzle</i>
Tratamiento anti bacteriano STERITOUCH	<i>STERITOUCH anti-bacterial treatment</i>
Diseño moderno	<i>Modern design</i>
Filtro incluido	<i>Filter included</i>
Tornillería antivandálica	<i>Vandal-proof screws</i>
Medidas 272 x 226 x 165 mm	<i>Measurements 272 x 226 x 165 mm</i>

Características técnicas *Technical features*



Voltaje <i>Voltage</i>	220 - 240 V	Consumo <i>Power consumption</i>	4,8 A
Frecuencia <i>Frequency</i>	50 / 60 Hz	Aislamiento eléctrico <i>Electrical insulation</i>	Class I
Velocidad aire <i>Air speed</i>	332 km/h	Protección <i>Protection level</i>	IP24
Caudal aire <i>Airflow</i>	178 m³/h	Tiempo de secado <i>Drying time</i>	12"
Temperatura aire <i>Air temperature</i>	40 °C	Sonoridad a 2 m <i>Sound level at 2 m</i>	72 dBA
Potencia total <i>Total power</i>	1.100 W	rpm <i>rpm</i>	34.000
Potencia resistencia <i>Power of heating element</i>	-	Desconexión anti vandálica <i>Automatic shut-off</i>	30"
Potencia motor <i>Motor power</i>	1.100 W	Garantía (años) <i>Warranty (years)</i>	5

NEW
Ref. GW01 16 01 00
 3 mm ABS
 Blanco *White*



NEW
Ref. GW01 16 01 04
 3 mm ABS
 Plateado *Silver*

HEPA

Secamanos *Hand dryer* **Condor**

Automático	<i>Sensor operated</i>
Estructura antivandálica	<i>Anti-vandalism structure</i>
Tiempo de secado rápido	<i>Ultra fast drying time</i>
Diseño moderno	<i>Modern design</i>
Filtro HEPA incluido	<i>HEPA filter included</i>
Recogedor de agua incluido	<i>Water tank included</i>
Medidas 574 x 297 x 164 mm	<i>Measurements 574 x 297 x 164 mm</i>

Características técnicas *Technical features*



Voltaje <i>Voltage</i>	220 - 240 V	Aislamiento eléctrico <i>Electrical insulation</i>	Class II
Frecuencia <i>Frequency</i>	50 / 60 Hz	Protección <i>Protection level</i>	IPX4
Velocidad aire <i>Air speed</i>	400 Km/h	Peso <i>Weight</i>	6 Kg
Caudal aire <i>Airflow</i>	90 m ³ /h	Tiempo de secado <i>Drying time</i>	12"
Temperatura aire <i>Air temperature</i>	44 °C	Sonoridad a 2 m <i>Sound level at 2 m</i>	77 dBA
Potencia total <i>Total power</i>	1.800 W	rpm <i>rpm</i>	33.000
Potencia resistencia <i>Power of heating element</i>	600 W	Desconexión anti vandálica <i>Automatic shut-off</i>	30"
Potencia motor <i>Motor power</i>	1.200 W	Garantía (años) <i>Warranty (years)</i>	3
Consumo <i>Power consumption</i>	7,8 A		

Ref. GW01 15 01 04

3 mm ABS

Plateado *Silver*

Ref. GW01 15 01 04V1

Opción 110V *Option 110V*



Ref. GW01 15 01 00

3 mm ABS

Blanco *White*

Secamanos *Hand dryer*

BLADEflow

Automático	<i>Sensor operated</i>
Larga duración debido a motor sin escobillas	<i>Brushless motor ensures high reliability</i>
Estructura antivandálica	<i>Anti-vandalism structure</i>
Tiempo de secado rápido	<i>Ultra fast drying time</i>
Diseño moderno	<i>Modern design</i>
Filtro HEPA incluido	<i>HEPA filter included</i>
Recogedor de agua incluido	<i>Water tank included</i>
Medidas 680 x 300 x 250 mm	<i>Measurements 680 x 300 x 250 mm</i>

Características técnicas *Technical features*



Voltaje <i>Voltage</i>	220 - 240 V	Aislamiento eléctrico <i>Electrical insulation</i>	Class I
Frecuencia <i>Frequency</i>	50 / 60 Hz	Protección <i>Protection level</i>	IP22
Velocidad aire <i>Air speed</i>	396 km/h	Peso <i>Weight</i>	8,5 kg
Caudal aire <i>Airflow</i>	200 m ³ /h	Tiempo de secado <i>Drying time</i>	10"
Temperatura aire <i>Air temperature</i>	40 °C	Sonoridad a 2 m <i>Sound level at 2 m</i>	76 dBA
Potencia total <i>Total power</i>	1.400 W	rpm <i>rpm</i>	35.000
Potencia resistencia <i>Power of heating element</i>	700 W	Desconexión anti vandálica <i>Automatic shut-off</i>	18"
Potencia motor <i>Motor power</i>	700 W	Garantía (años) <i>Warranty (years)</i>	3
Consumo <i>Power consumption</i>	8 A		

Ref. GW01 18 04 00
 1 mm acero inoxidable
 1 mm stainless steel
 Epoxi Blanco *White Epoxy*



Ref. GW01 18 04 03
 1 mm acero inoxidable
 1 mm stainless steel
 Negro *Black*



Ref. GW01 18 04 01
 1 mm acero inoxidable
 1 mm stainless steel
 Satinado *Brushed*

Secamanos *Hand dryer*

BLADEflow-2

Automático	<i>Sensor operated</i>
Consumo altamente eficiente	<i>Highly energy efficient</i>
Secado muy rápido	<i>Fast drying time</i>
Carcasa antivandálica en acero inoxidable	<i>Anti-vandalism stainless steel cover</i>
Diseño exclusivo	<i>Exclusive design</i>
Filtro HEPA incluido	<i>HEPA filter included</i>
Recogedor de agua incluido	<i>Water tank included</i>

Características técnicas *Technical features*



Voltaje <i>Voltage</i>	220 - 240 V	Aislamiento eléctrico <i>Electrical insulation</i>	Class I
Frecuencia <i>Frequency</i>	50 / 60 Hz	Protección <i>Protection level</i>	IPX1
Velocidad aire <i>Air speed</i>	342 km/h	Peso <i>Weight</i>	13 kg
Caudal aire <i>Airflow</i>	228 m³/h	Tiempo de secado <i>Drying time</i>	10"
Temperatura aire <i>Air temperature</i>	60 °C	Sonoridad a 2 m <i>Sound level at 2 m</i>	75 dBA
Potencia total <i>Total power</i>	1.650 W	rpm <i>rpm</i>	20.000
Potencia resistencia <i>Power of heating element</i>	850 W	Desconexión anti vandálica <i>Automatic shut-off</i>	60"
Potencia motor <i>Motor power</i>	800 W	Garantía (años) <i>Warranty (years)</i>	3
Consumo <i>Power consumption</i>	10 A		

NEW
Ref. GW01 21 04 01
 1,5 mm acero inoxidable
1.5 mm stainless steel
 Satinado *Brushed*



NEW
Ref. GW01 21 04 03
 1,5 mm acero inoxidable
1.5 mm stainless steel
 Negro mate *Matt black*

Secamanos *Hand dryer*

EXO SLIM

Automático	<i>Sensor operated</i>
Altamente eficiente	<i>Highly energy efficient</i>
Secado muy rápido	<i>Fast drying time</i>
Velocidad ajustable	<i>Adjustable speed</i>
Adaptado a normativa ADA	<i>ADA compliant</i>
Resistencia ON/OFF	<i>ON/OFF heating element</i>
Diseño ultracompacto	<i>Ultra slim design</i>
Medidas 326 x 220 x 100 mm	<i>Measurements 326 x 220 x 100 mm</i>

Características técnicas *Technical features*



Voltaje <i>Voltage</i>	220 - 240 V	Aislamiento eléctrico <i>Electrical insulation</i>	Class I
Frecuencia <i>Frequency</i>	50 / 60 Hz	Protección <i>Protection level</i>	IPX4
Velocidad aire <i>Air speed</i>	223 - 315 Km/h	Peso <i>Weight</i>	4,4 Kg
Caudal aire <i>Airflow</i>	83 - 119 m ³ /h	Tiempo de secado <i>Drying time</i>	15"
Temperatura aire <i>Air temperature</i>	42 °C	Sonoridad a 2 m <i>Sound level at 2 m</i>	74 - 77 dBA
Potencia total <i>Total power</i>	1.000 W	rpm <i>rpm</i>	30.000
Potencia resistencia <i>Power of heating element</i>	450 W	Desconexión anti vandálica <i>Automatic shut-off</i>	30"
Potencia motor <i>Motor power</i>	550 W	Garantía (años) <i>Warranty (years)</i>	3
Consumo <i>Power consumption</i>	4,3 A		

Ref. GW01 12 02 00
2,5 mm aluminio *2.5 mm aluminium*
Epoxi blanco *White epoxy*

Ref. GW01 12 02 00V1
Opción 110V / *Option 110V*

Ref. GW01 12 02 01
2,5 mm aluminio *2.5 mm aluminium*
Satinado *Brushed*

Ref. GW01 12 02 01V1
Opción 110V *Option 110V*



Ref. GW01 12 02 04
2,5 mm aluminio *2.5 mm aluminium*
Plateado *Silver*

Ref. GW01 12 02 04V1
Opción 110V *Option 110V*

Secamanos *Hand dryer*

E-flow

Resistencia ON / OFF	<i>ON / OFF Heating element</i>
Altamente eficiente	<i>Highly energy efficient</i>
Consumo reducido	<i>Low power consumption</i>
LED azul incorporado	<i>Blue LED incorporated</i>
Diseño moderno	<i>Modern design</i>

Características técnicas *Technical features*



Voltaje <i>Voltage</i>	220 - 240 V	Aislamiento eléctrico <i>Electrical insulation</i>	Class I
Frecuencia <i>Frequency</i>	50 / 60 Hz	Protección <i>Protection level</i>	IP22
Velocidad aire <i>Air speed</i>	230 km/h	Peso <i>Weight</i>	4,5 kg
Caudal aire <i>Airflow</i>	140 m ³ /h	Tiempo de secado <i>Drying time</i>	15"
Temperatura aire <i>Air temperature</i>	46 °C	Sonoridad a 2 m <i>Sound level at 2 m</i>	72 dBA
Potencia total <i>Total power</i>	900 W	rpm <i>rpm</i>	23.000
Potencia resistencia <i>Power of heating element</i>	250 W	Desconexión anti vandálica <i>Automatic shut-off</i>	60"
Potencia motor <i>Motor power</i>	650 W	Garantía (años) <i>Warranty (years)</i>	3
Consumo <i>Power consumption</i>	3,9 A		

 **Ref. GW01 25 04 01**
 Acero inoxidable 2 mm
 2 mm stainless steel
 Satinado Brushed
 Automático Sensor operated

 **Ref. GW01 25 04 02**
 Acero inoxidable 2 mm
 2 mm stainless steel
 Brillante Polished
 Automático Sensor operated





 **Ref. GW01 25 03 00**
 Acero 2 mm 2 mm steel
 Blanco White
 Automático Sensor operated



Ref. GW01 26 03 00 
 Acero 2 mm 2 mm steel
 Blanco White
 Manual Push button operated



Ref. GW01 26 04 01 
 Acero inoxidable 2 mm
 2 mm stainless steel
 Satinado Brushed
 Manual Push button operated

Ref. GW01 26 04 02 
 Acero inoxidable 2 mm
 2 mm AISI stainless steel
 Brillante Polished
 Manual Push button operated

Secamanos Hand dryer

Classicflow

Automático o pulsador *Sensor or push button operated*
 Carcasa antivandálica de 2mm *Durable and resistant 2mm casing*
 Tornillería antivandálica *Vandal-proof screws*
 Medidas 240 x 265 x 205 mm *Measurements 240 x 265 x 205 mm*

Características técnicas Technical features



Voltaje Voltage	220 - 240 V	Aislamiento eléctrico Electrical insulation	Class I
Frecuencia Frequency	50 / 60 Hz	Protección Protection level	IP23
Velocidad aire Air speed	95 Km/h	Peso Weight	5,3 Kg
Caudal aire Airflow	210m ³ /h	Tiempo de secado Drying time	25"
Temperatura aire Air temperature	65°C	Sonoridad a 2 m Sound level at 2 m	75 dBA
Potencia total Total power	2.500 W	rpm rpm	8.200
Potencia resistencia Power of heating element	2.220 W	Desconexión anti vandálica Automatic shut-off	90"
Potencia motor Motor power	280 W	Duración pulsador Push button timer	60"
Consumo Power consumption	11 A	Garantía (años) Warranty (years)	3

NEW
Ref. GW01 17 01 00
 3 mm ABS *3 mm ABS*
 Blanco *White*



NEW
Ref. GW01 17 01 03
 3 mm ABS *3 mm ABS*
 Negro *Black*



NEW
Ref. GW01 17 04 01
 1,2 mm acero inoxidable
1.2 mm stainless steel
 Satinado *Brushed*



NEW
Ref. GW01 17 04 02
 1,2 mm acero inoxidable
1.2 mm stainless steel
 Brillante *Polished*



NEW
Ref. GW01 17 04 03
 1,2 mm acero inoxidable
1.2 mm stainless steel
 Negro mate *Matt black*

Secamanos *Hand dryer*

NEO

Automático	<i>Sensor Operated</i>
Altamente eficiente	<i>Highly energy efficient</i>
Secado muy rápido	<i>Fast drying time</i>
Adaptado a normativa ADA	<i>ADA compliant</i>
Diseño ultracompacto	<i>Ultra slim design</i>
Medidas 347 x 280 x 100 mm	<i>Measurements 347 x 280 x 100 mm</i>

Características técnicas *Technical features*



Voltaje <i>Voltage</i>	220 - 240 V	Aislamiento eléctrico <i>Electrical insulation</i>	Class II
Frecuencia <i>Frequency</i>	50 / 60 Hz	Protección <i>Protection level</i>	IPX1
Velocidad aire <i>Air speed</i>	295 Km/h	Peso <i>Weight</i>	1,6 / 2,8 Kg
Caudal aire <i>Airflow</i>	94 m ³ /h	Tiempo de secado <i>Drying time</i>	20"
Temperatura aire <i>Air temperature</i>	48 °C	Sonoridad a 2 m <i>Sound level at 2 m</i>	77 dBA
Potencia total <i>Total power</i>	950 W	rpm <i>rpm</i>	31.000
Potencia resistencia <i>Power of heating element</i>	400 W	Desconexión anti vandálica <i>Automatic shut-off</i>	30"
Potencia motor <i>Motor power</i>	550 W	Garantía (años) <i>Warranty (years)</i>	3
Consumo <i>Power consumption</i>	4,1 A		



Ref. GW01 14 04 01
 1,2 mm acero inoxidable
1.2 mm stainless steel
 Satinado *Brushed*

Ref. GW01 14 04 01V1
 Opción 110V *Option 110V*



Ref. GW01 14 01 00
 3 mm ABS
 Blanco *White*

Ref. GW01 14 01 00V1
 Opción 110V *Option 110V*



Ref. GW01 14 03 00
 1,2 mm acero *1.2 mm steel*
 Epoxi blanco *White epoxy*

Ref. GW01 14 03 00V1
 Opción 110V *Option 110V*



Ref. GW01 14 04 02
 1,2 mm acero inoxidable
1.2 mm stainless steel
 Brillante *Polished*

Secamanos *Hand dryer*

WECflow

<p>Automático Motor de inducción Fiabilidad máxima Variedad de carcasas Tornillería antivandálica Baja sonoridad</p>	<p><i>Sensor operated</i> <i>Induction motor</i> <i>Highly reliable</i> <i>Large range of covers</i> <i>Vandal-proof screws</i> <i>Quiet sound level</i></p>
---	---

Características técnicas *Technical features*

Voltaje <i>Voltage</i>	220 - 240 V	Aislamiento eléctrico <i>Electrical insulation</i>	Class I
Frecuencia <i>Frequency</i>	50 / 60 Hz	Protección <i>Protection level</i>	IPX1
Velocidad aire <i>Air speed</i>	65 km/h	Peso <i>Weight</i>	4,1 kg
Caudal aire <i>Airflow</i>	240 m ³ /h / 4.000 l/min	Tiempo de secado <i>Drying time</i>	39"
Temperatura aire <i>Air temperature</i>	65 °C	Sonoridad a 2 m <i>Sound level at 2 m</i>	60 dBA
Potencia total <i>Total power</i>	1.900 W	rpm <i>rpm</i>	2.800
Potencia resistencia <i>Power of heating element</i>	1.840 W	Desconexión anti vandálica <i>Automatic shut-off</i>	90"
Potencia motor <i>Motor power</i>	60 W	Garantía (años) <i>Warranty (years)</i>	3
Consumo <i>Power consumption</i>	7,5 A		





NEW

Ref. GW01 90 01 03





Protector de pared *Splash back wall guard*

GW-CLEAN

Secado instantáneo del agua	<i>Instantly absorbs & evaporates water</i>
Antimoho	<i>Anti-mildew</i>
Sin salpicaduras	<i>No water splashbacks</i>
Evita crecimiento bacterias	<i>No bacterial growth</i>
Evita agua en el suelo	<i>No water floors</i>
Fácil de limpiar	<i>Easy to clean</i>

Secamanos *Hand Dryers*

Zonas de alto tráfico *High traffic zones*

		Falcon	Verdedri	Smartdri Plus	Airforce
Motor	Inducción <i>Brushless</i>				
	Con escobillas <i>Brushes</i>	•	•	•	•
Funcionamiento <i>Operation</i>	Manual				
	Sensor	•	•	•	•
Carcasa <i>Casing</i>	Acero inoxidable <i>Stainless steel</i>	•	•	•	•
	Acero <i>Steel</i>				
	Aluminio <i>Aluminium</i>		•	•	•
	ABS				
Filtración <i>Filtration</i>	Filtro Hepa <i>Hepa filtration</i>	•	•		
Ajuste <i>Adjustability</i>	Potencia <i>Power</i>	•	•	•	
	Detección sensor <i>Sensor detection</i>	•	•	•	•
	Resistencia <i>Heating element</i>	•		•	
IP	IP24	•	•	•	•
	IP23				
	IP22				
	IPX1				
Seguridad <i>Security attributes</i>	Antivándalico <i>Vandal proof</i>	•	•	•	•
	Apagado automático <i>Auto shut-off</i>	•	•	•	•
Garantía <i>Warranty</i>	5 años years	•	•	•	•
	3 años years				
Características destacadas <i>Features</i>	ADA Cumple normativa ADA <i>ADA standard</i>		•		
	 Producto anti vandálico <i>Anti-vandalism product</i>	•	•	•	•
	 Para personas con movilidad reducida <i>Disability aid</i>		•		
	 Funcionamiento automático <i>Sensor operated</i>	•	•	•	•
	 Funcionamiento manual <i>Manually operated</i>				

Zonas de tráfico medio *Medium traffic zones*

Zonas de bajo tráfico *Low traffic zones*

Slimdri	Exoslim	Condor	E-flow	Neo	Classicflow	Bladeflow	Bladeflow-2	Wecflow
						•		•
•	•	•	•	•	•		•	
					•			
•	•	•	•	•	•	•	•	•
•	•			•	•		•	•
					•			•
•			•					
		•		•		•		•
	•	•		•		•	•	
	•							
•	•		•	•				•
•	•		•					
•								
			•			•		
				•	•		•	•
•	•	•	•	•		•	•	•
•	•	•	•	•	•	•	•	•
•								
	•	•	•	•	•	•	•	•
•	•			•				
•	•	•	•	•	•		•	
•	•			•				
•	•	•	•	•	•	•	•	•
					•			



Baño de aeropuerto *Airport bathroom*



Secadores de pelo

Hair dryers



Secado rápido *Fast dry*

1800W de potencia con secado iónico
1800W total power with ion air

Diseño moderno *Stylish design*

Acabado en negro mate con acabados cromados
Matt black with chrome trim

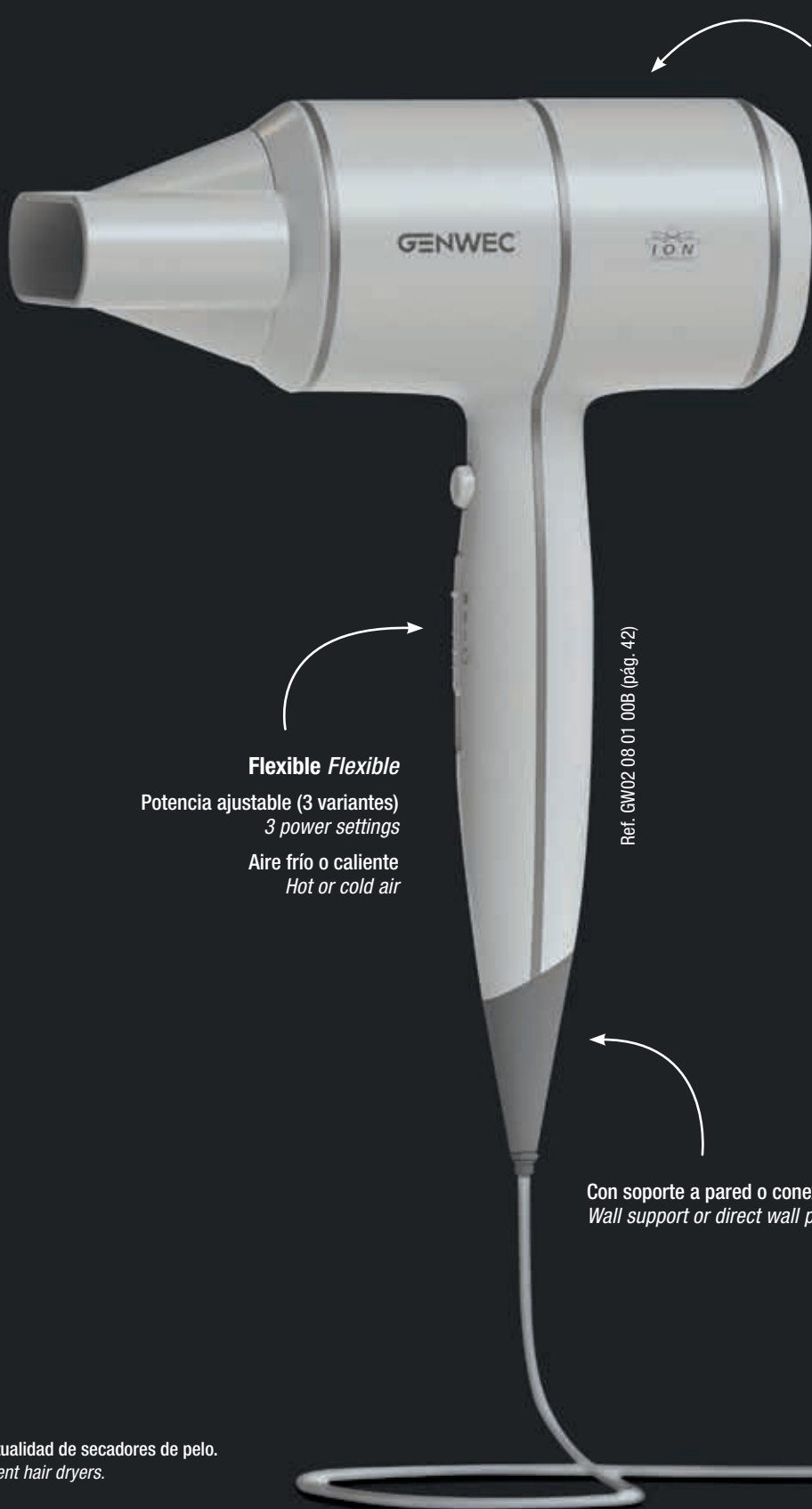

Seguridad en el uso *User's safety*

Limitador térmico de seguridad
Safety thermal cut-off

Flexible *Flexible*
Potencia ajustable (3 variantes)
3 power settings
Aire frío o caliente
Hot or cold air

Ref. GW02 08 01 00B (pág. 42)

Características destacadas
Features

2 Velocidades
2 Speedes **2**
SPEEDS

3 Velocidades
3 Speedes **3**
SPEEDS

Tecnología iónica
Ion technology **ION**
TECHNOLOGY

Conexión directa a enchufe
Direct connection to power socket 

Con soporte a pared o conexión directa (se suministra bolsa)
Wall support or direct wall plug-in (drawstring bag included)



Más sobre la actualidad de secadores de pelo.
More about current hair dryers.

Ref. GW02 01 01 00
 ABS Blanco *White ABS*
 Rejilla de ventilación en ABS cromado
Chromed ABS ventilation grill



Secadores de pelo *Hair dryers*

Bali

1200W

Características técnicas *Technical features*

Voltaje <i>Voltage</i>	220 - 240 V	Potencia motor <i>Motor power</i>	40 W
Frecuencia <i>Frequency</i>	50 / 60 Hz	Aislamiento eléctrico <i>Electrical insulation</i>	Class II
Velocidad aire <i>Air speed</i>	55 km/h	Peso <i>Weight</i>	0,65 kg
Caudal aire <i>Airflow</i>	75 m ³ /h 1.250 l/min	rpm <i>rpm</i>	10.000
Potencia total <i>Total power</i>	600 - 1.200 W	Con interruptor de seguridad <i>With security switch</i>	
Potencia resistencia <i>Power of heating element</i>	1.160 W		



Ref. GW02 02 01 00

ABS Blanco *White ABS*

Rejilla de ventilación en ABS cromado
Chromed ABS ventilation grill

Secadores de pelo *Hair dryers*

Pontia
1400W

Características técnicas *Technical features*

Voltaje <i>Voltage</i>	220 - 240 V	Potencia motor <i>Motor power</i>	40 W
Frecuencia <i>Frequency</i>	50 / 60 Hz	Aislamiento eléctrico <i>Electrical insulation</i>	Class II
Velocidad aire <i>Air speed</i>	55 km/h	Peso <i>Weight</i>	1 kg
Caudal aire <i>Airflow</i>	75 m ³ /h 1.250 l/min	rpm <i>rpm</i>	10.000
Potencia total <i>Total power</i>	700 - 1.400 W	Con interruptor de seguridad <i>With security switch</i>	
Potencia resistencia <i>Power of heating element</i>	1.360 W	Especialmente diseñado para instalación en cajón <i>Specially designed for drawer installation</i>	



Ref. GW02 03 01 00

ABS Blanco *White ABS*

Rejilla de ventilación en ABS cromado
Chromed ABS ventilation grill

Ref. GW02 03 01 00V1

Opción 110V *Option 110V*

Ref. GW02 03 01 03

ABS Negro *Black ABS*

Rejilla de ventilación en ABS cromado
Chromed ABS ventilation grill

Secadores de pelo *Hair dryers*

Mistral

1800W

Características técnicas *Technical features*

Voltaje <i>Voltage</i>	220 - 240 V	Potencia motor <i>Motor power</i>	130 W
Frecuencia <i>Frequency</i>	50 / 60 Hz	Aislamiento eléctrico <i>Electrical insulation</i>	Class II
Velocidad aire <i>Air speed</i>	131 Km/h	Peso <i>Weight</i>	1,0 Kg
Caudal aire <i>Airflow</i>	75 m ³ /h 1.250 l/min	rpm <i>rpm</i>	10.000
Potencia total <i>Total power</i>	128 / 1.800 W	Enchufe europeo / americano para afeitadora <i>With European / American plug for shaver</i>	
Potencia resistencia <i>Power of heating element</i>	1.670 W	Con interruptor de seguridad <i>With security switch</i>	



Ref. GW02 08 01 00
Blanco White

Ref. GW02 08 01 03
Negro Black

Ref. GW02 08 01 00B
Blanco White

Ref. GW02 08 01 03B
Negro Black

Secadores de pelo Hair dryers

Bise
Iónico Ionic 1800W

Características técnicas Technical features

Voltaje Voltage	220 - 240 V	Potencia motor Motor power	598 W
Frecuencia Frequency	50 / 60 Hz	Aislamiento eléctrico Electrical insulation	Class II
Velocidad aire Air speed	59 km/h	Peso Weight	0,6 Kg
Caudal aire Airflow	120 m³/h 2.000 l/min	rpm rpm	10.000
Temperatura aire Air temperature	55°C	Tres velocidades/aire frío o caliente Three speed settings/cold or hot air	
Potencia total Total power	1.800 W	Interruptor de seguridad y 2 conectores USB Security switch & 2 USB connectors	
Potencia resistencia Power of heating element	1.202 W		



Habitación de hotel *Hotel room*



Dispensadores de papel

Paper dispensers

Ref. GW03 05 04 03 (pág. 48)

Nuevo diseño negro mate en acero
inoxidable AISI 304
*New matt black design in AISI 304
stainless steel*

Apto para papeles tipo "C" y "Z"
Suitable for "C" and "Z" fold paper



Ref. GW03 02 04 03 (pág. 47)



Anillas de goma interiores
para fijar el rollo de papel
*Interior rubber rings to fix
paper roll*

Bordes suaves para prevenir autolesiones
Smooth corner to prevent self-injury



Más sobre la actualidad de dispensadores de papel.
More about current paper dispensers.

Ref. GW03 02 04 01
 Acero inoxidable 304
 AISI 304 stainless steel
 Satinado *Brushed*



Ref. GW03 02 04 02
 Acero inoxidable 304
 AISI 304 stainless steel
 Brillante *Polished*



Ref. GW03 02 04 03
 Acero inoxidable 304
 AISI 304 stainless steel
 Negro mate *Matt black*



Dispensador de papel jumbo *Toilet roll paper dispenser*

Instalación mural	<i>Surface mounted</i>
Llave seguridad central	<i>Center lock key</i>
Gomas en la cánula para fijar el rollo	<i>Rubber rings in core to fix paper roll</i>
Incorpora parte trasera	<i>With backplate</i>
Medidas 275 x 275 x 121 mm	<i>Measurements 275 x 275 x 121 mm</i>

Ref. GW03 04 04 01
 Acero inoxidable 304
 AISI 304 stainless steel
 Satinado *Brushed*



Ref. GW03 04 04 02
 Acero inoxidable 304
 AISI 304 stainless steel
 Brillante *Polished*



Ref. GW03 04 04 03
 Acero inoxidable 304
 AISI 304 stainless steel
 Negro mate *Matt black*



Dispensador de papel toalla *Paper towel dispenser*

Capacidad 250 toallas tipo C	<i>250 C-type towel capacity</i>
Capacidad 300 toallas tipo Z	<i>300 Z-type towel capacity</i>
Llave seguridad en parte superior	<i>Upper lock key</i>
Medidas 203 x 279 x 102 mm	<i>Measurements 203 x 279 x 102 mm</i>

Ref. GW03 05 04 01
Acero inoxidable 304
AISI 304 stainless steel
Satinado *Brushed*



Ref. GW03 05 04 02
Acero inoxidable 304
AISI 304 stainless steel
Brillante *Polished*



Ref. GW03 05 04 03
Acero inoxidable 304
AISI 304 stainless steel
Negro mate *Matt black*



Dispensador de papel toalla *Paper towel dispenser*

Capacidad 450 toallas tipo C	<i>450 C-type towel capacity</i>
Capacidad 600 toallas tipo Z	<i>600 Z-type towel capacity</i>
Llave seguridad en parte superior	<i>Upper lock key</i>
Medidas 389 x 279 x 102 mm	<i>Measurements 389 x 279 x 102 mm</i>

Ref. GW03 24 04 01
Acero inoxidable 304
AISI 304 stainless steel
Satinado *Brushed*



Dispensador de papel toalla automático *Automatic paper towel dispenser*

Capacidad 450 toallas tipo C	<i>450 C-type towel capacity</i>
Capacidad 600 toallas tipo Z	<i>600 Z-type towel capacity</i>
Llave seguridad en parte lateral	<i>Lateral lock key</i>

Ref. GW03 28 04 01
Acero inoxidable 304
AISI 304 stainless steel
Satinado *Brushed*

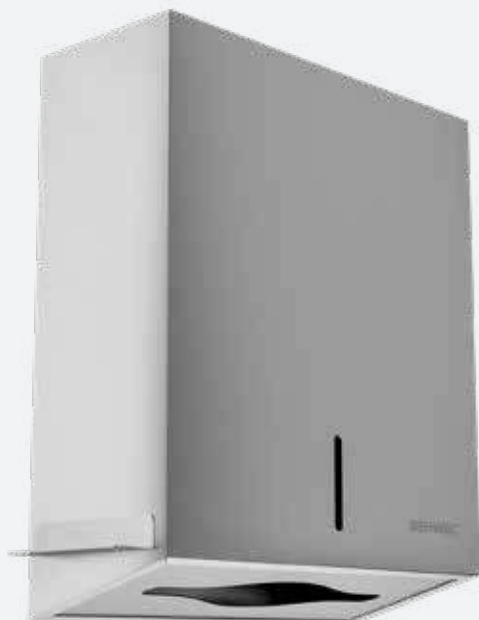

Ref. GW03 29 04 01
Acero inoxidable 304
AISI 304 stainless steel
Satinado *Brushed*



Dispensador de papel toalla detrás de espejo *Behind mirror paper dispenser*

Instalación detrás de espejo *Behind mirror installation*
Capacidad 450 toallas tipo C *450 C-type towel capacity*
Capacidad 600 toallas tipo Z *600 Z-type towel capacity*

Ref. GW03 27 04 01
Acero inoxidable 304
AISI 304 stainless steel
Satinado *Brushed*

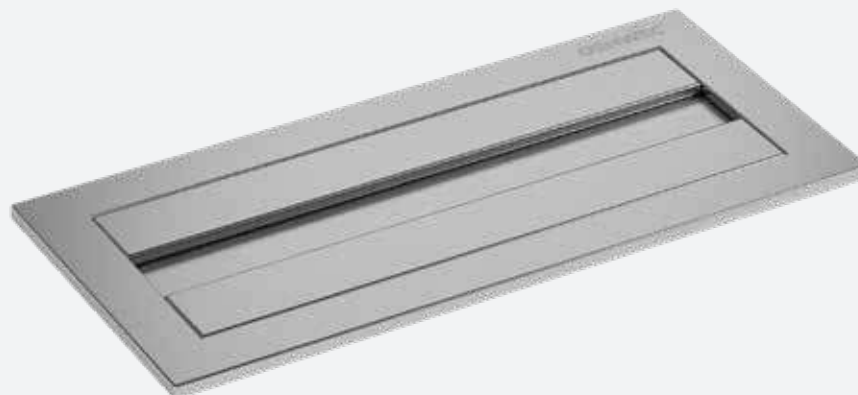

Dispensador de papel toalla de encimera *Countertop paper dispenser*

Instalación encastrada *Countertop installation*
Fácil extracción y reposición de papel *Easy paper towel extraction and refill*



Ref. GW03 12 04 01
Acero inoxidable 304
AISI 304 stainless steel
Satinado *Brushed*
Mural *Surface mounted*
Medidas *Measurements*
305 x 153 x 171 mm



Ref. GW03 13 04 01
Acero inoxidable 304
AISI 304 stainless steel
Satinado *Brushed*
Encastrado *Built-in*
Medidas *Measurements*
337 x 185 x 171 mm

Dispensador de papel doble rollo *Two roll paper dispenser*

Cierre con llave seguridad *Safety lock closure*

Ref. GW03 08 04 02
Acero inoxidable 304
AISI 304 stainless steel
Brillante *Polished*
Medidas *Measurements*
158 x 164 x 70 mm



Ref. GW03 08 04 01
Satinado *Brushed*



Ref. GW03 10 04 02
Acero inoxidable 304
AISI 304 stainless steel
Brillante *Polished*
Medidas *Measurements*
160 x 300 x 70 mm

Ref. GW03 10 04 01
Satinado *Brushed*

Dispensador de papel unitario o doble *Single or double paper dispenser*

Portarrollos de 1 o 2 rollo *1 or 2 rolls paper dispenser*
Mural *Surface mounted*

Ref. GW03 09 04 02
 Acero inoxidable 304
AISI 304 stainless steel
 Brillante *Polished*
 Medidas *Measurements*
 163 x 155 x 70 mm



Ref. GW03 11 04 02
 Acero inoxidable 304
AISI 304 stainless steel
 Brillante *Polished*
 Medidas *Measurements*
 158 x 298 x 68 mm

Dispensador de papel unitario o doble *Single or double paper dispenser*

Portarrollos de 1 o 2 rollo *1 or 2 rolls paper dispenser*
 Encastrados *Built-in*

Ref. GW03 14 04 01
 Acero inoxidable 304
AISI 304 stainless steel
 Satinado *Brushed*



Ref. GW03 14 03 00
 Acero *Steel*
 Epoxi blanco *White epoxy*



Ref. GW03 14 04 02
 Acero inoxidable 304
AISI 304 stainless steel
 Brillante *Polished*

Dispensador de papel cubre asientos *Seat cover paper dispenser*

Dispensador papel 1/4 plegado para cubrir asientos inodoro *Wall mounted 1/4 folded toilet seat cover dispenser*
 Cierre con llave de seguridad *Safety lock closure*
 Medidas 290 x 230 x 50 mm *Measurements 290 x 230 x 50 mm*

Ref. GW03 15 04 01
Acero inoxidable 304
AISI 304 stainless steel
Satinado *Brushed*



Dispensador papel cubre asientos encastrado *Built-in seat cover dispenser*

Medidas 322 x 432 x 70 mm *Measurements 322 x 432 x 70 mm*
Medidas hueco 276 x 386 x 70 mm *Wall hole measurements 276 x 386 x 70 mm*

Ref. GW03 25 04 01
Acero inoxidable 304
AISI 304 stainless steel
Satinado *Brushed*



Ref. GW03 25 04 02
Acero inoxidable 304
AISI 304 stainless steel
Brillante *Polished*



Dispensador de bolsas higiénicas *Hygienic bag dispenser*

Instalación mural *Surface mounted*
Fácil extracción de bolsas *Easy bag extraction*
Medidas 135 x 96 x 26,5 mm *Measurements 135 x 96 x 26,5 mm*

Ref. GW03 18 01 04
ABS Plateado *Silver ABS*



Ref. GW03 18 01 00
ABS Blanco *White ABS*



Dispensador de papel doble *Two roll paper dispenser*

Apto para toallitas individuales	<i>Suitable for interleave toilet paper</i>
Material ABS	<i>ABS Material</i>
Instalación mural	<i>Surface mounted</i>
Llave seguridad en parte superior	<i>Upper lock key</i>
Medidas: 275 x 148 x 138 mm	<i>Measurements: 275 x 148 x 138 mm</i>
Medidas rollo: Ø 120 x 110 mm	<i>Paper roll size: Ø 120 x 110 mm</i>
Medidas toallitas: 245 x 135 x 120 mm	<i>Z folded paper size: 245 x 135 x 120 mm</i>

Ref. GW03 20 01 04
ABS Plateado *Silver ABS*



Ref. GW03 20 01 00
ABS Blanco *White ABS*



Dispensador de papel toalla *Paper towel dispenser*

Material ABS	<i>ABS Material</i>
Llave seguridad en parte superior	<i>Upper lock key</i>
Capacidad 450 toallas tipo C	<i>450 C-type towel capacity</i>
Capacidad 600 toallas tipo Z	<i>600 Z-type towel capacity</i>
Medidas: 300 x 260 x 130 mm	<i>Measurements: 300 x 260 x 130 mm</i>

Ref. GW03 19 01 04
ABS Plateado *Silver ABS*



Ref. GW03 19 01 00
ABS Blanco *White ABS*



Dispensador de papel jumbo *Toilet roll paper dispenser*

Material ABS	<i>ABS Material</i>
Instalación mural	<i>Surface mounted</i>
Llave seguridad en parte superior	<i>Upper lock key</i>
Medidas: 281 x 271 x 130 mm	<i>Measurements: 281 x 271 x 130 mm</i>
Dos opciones de cánula: Ø 48 o Ø 73 mm	<i>Two core options: Ø 48 or Ø 73 mm</i>

Ref. GW03 21 01 04
ABS Plateado *Silver ABS*



Ref. GW03 21 01 00
ABS Blanco *White ABS*



Dispensador de papel mecha *Centrefeed paper dispenser*

Material ABS	<i>ABS Material</i>
Llave seguridad en parte superior	<i>Upper lock key</i>
Diámetro rollo 190 mm	<i>Roll diameter 190 mm</i>
Medidas: 310 x 240 x 240 mm	<i>Measurements: 310 x 240 x 240 mm</i>



Baño público *Public bathroom*



GENWEC®



Ideal para zona de alto tráfico
Suitable for high traffic zones

1.100ml Capacidad
1.100ml Capacity

1ml Dosis
1ml Dose

Dosificadores de jabón

Soap dispensers



Antivandálico y resistente
Durable and vandal proof

Cerrado con llave de seguridad
Closed with security lock

Máxima higiene *Maximum hygiene*

Funcionamiento con sensor
Sensor operated - No touch

Válvula anti-goteo
Non drip pump mechanism

Ref. GM04 16 04 01 (pág.60)

Características destacadas

Features



Espuma
Foam



Jabón
Soap



Gel
Gel



Spray
Spray



Funcionamiento automático
Sensor operated



Más sobre la actualidad de dispensadores de jabón.
More about current soap dispensers.

 **Ref. GW04 01 04 01**
 Acero inoxidable 304
AISI 304 stainless steel
 Satinado *Brushed*



Ref. GW04 01 04 02 
 Acero inoxidable 304
AISI 304 stainless steel
 Brillante *Polished*



Dosificador de jabón manual *Manual soap dispenser*

Vertical	<i>Vertical</i>
Capacidad 1.100 ml	<i>1.100 ml capacity</i>
Déposito interior de plástico	<i>Plastic interior deposit</i>
Válvula anti goteo	<i>Anti-drip valve</i>
Visor de llenado	<i>Level viewer</i>
Medidas 210 x 124 x 137	<i>Measurements 210 x 125 x 137 mm</i>

 **Ref. GW04 01 04 01B**
 Acero inoxidable 304
AISI 304 stainless steel
 Satinado *Brushed*
 Válvula ABS *ABS push button*



Ref. GW04 01 04 02B 
 Acero inoxidable 304
AISI 304 stainless steel
 Brillante *Polished*
 Válvula ABS *ABS push button*



NEW
Ref. GW04 01 04 03B 
 Acero inoxidable 304
AISI 304 stainless steel
 Negro mate *Matt black*
 Válvula ABS *ABS push button*



Dosificador de jabón manual *Manual soap dispenser*

Vertical	<i>Vertical</i>
Capacidad 1.100 ml	<i>1.100 ml capacity</i>
Déposito interior de plástico	<i>Plastic interior deposit</i>
Válvula anti goteo	<i>Anti-drip valve</i>
Visor de llenado	<i>Level viewer</i>
Medidas 210 x 124 x 137	<i>Measurements 210 x 125 x 137 mm</i>

 **Ref. GW04 02 04 01**
 Acero inoxidable 304
AISI 304 stainless steel
 Satinado *Brushed*



Ref. GW04 02 04 02 
 Acero inoxidable 304
AISI 304 stainless steel
 Brillante *Polished*

Dosificador de jabón manual *Manual soap dispenser*



Horizontal	<i>Horizontal</i>
Capacidad 1.100 ml	<i>1.100 ml capacity</i>
Déposito interior de plástico	<i>Plastic interior deposit</i>
Válvula anti goteo	<i>Anti-drip valve</i>
Visor de llenado	<i>Level viewer</i>
Medidas 124 x 210 x 137	<i>Measurements 124 x 210 x 137 mm</i>



NEW
Ref. GW04 16 04 01
 Acero inoxidable 304
AISI 304 stainless steel
 Satinado *Brushed*



NEW

Ref. GW04 16 04 03   
 Acero inoxidable 304
AISI 304 stainless steel
 Negro mate *Matt black*



Dosificador automático de jabón y desinfectante *Automatic soap & sanitizer dispenser*

Funcionamiento automático	<i>Automatic operated</i>
Capacidad de 1.100ml	<i>1.100ml capacity</i>
Acepta gel hidroalcohólico	<i>Accepts hydroalcoholic gel</i>
Funcionamiento mediante 4 pilas AA	<i>Operated by 4 AA batteries</i>
Válvula anti goteo	<i>Non drip pump mechanism</i>
Visor de llenado	<i>Level viewer</i>
Medidas 270 x 145 x 104 mm	<i>Measurements 270 x 145 x 104 mm</i>



Ref. GW04 20 04 01
 Acero inoxidable 304
AISI 304 stainless steel
 Satinado *Brushed*



Ref. GW04 20 04 02

Acero inoxidable 304
AISI 304 stainless steel
 Brillante *Polished*

Dosificador de jabón automático *Automatic soap dispenser*

Funcionamiento automático	<i>Automatic operated</i>
Capacidad 1.200 ml	<i>1.200 ml capacity</i>
Funcionamiento mediante 4 pilas AA	<i>Operated by 4 AA batteries</i>
Dosis de 1ml	<i>1ml dose</i>
Válvula anti goteo	<i>Non drip pump mechanism</i>
Visor de llenado	<i>Level viewer</i>
Medidas 210 x 140 x 100	<i>Measurements 210 x 140 x 100 mm</i>



Ref. GW04 21 04 01
 Acero inoxidable 304
AISI 304 stainless steel
 Satinado *Brushed*



Ref. GW04 21 04 03

Acero inoxidable 304
AISI 304 stainless steel
 Negro mate *Matt black*

Dosificador de jabón manual *Manual soap dispenser*

Funcionamiento manual	<i>Manual operated</i>
Capacidad 1.800 ml	<i>1.800 ml capacity</i>
Dosis de 1ml	<i>1ml dose</i>
Válvula anti goteo	<i>Non drip pump mechanism</i>
Visor de llenado	<i>Level viewer</i>
Medidas 210 x 140 x 120	<i>Measurements 210 x 140 x 120 mm</i>

 **Ref. GW04 06 04 01**
Acero inoxidable 304
AISI 304 stainless steel
Satinado *Brushed*



Ref. GW04 06 04 02 
Acero inoxidable 304
AISI 304 stainless steel
Brillante *Polished*



Dosificador de jabón manual *Manual soap dispenser*

Funcionamiento manual	<i>Manual operated</i>
Capacidad 300 ml	<i>300 ml capacity</i>
Déposito interior de plástico	<i>Inner plastic receptacle</i>
Medidas 250 x ø 6 mm	<i>Measurements 250 x ø 6 mm</i>

 **Ref. GW04 15 04 02**
Acero inoxidable 304
AISI 304 stainless steel
Tapa de zinc *Zinc lid*
Brillante *Polished*



Dosificador de jabón manual *Manual soap dispenser*

Manual	<i>Manual operated</i>
Capacidad 300 ml	<i>300 ml capacity</i>
Depósito de plástico interior	<i>Inner plastic receptacle</i>
Medidas 168 x 80 x 156 mm	<i>Measurements 168 x 80 x 156 mm</i>

 **Ref. GW04 10 01 00**
ABS blanco *White ABS*
Polietileno *Polyethylene*
Longitud caño 127 mm
Spout long 127 mm



Ref. GW04 10 01 00B 
ABS blanco *White ABS*
Polietileno *Polyethylene*
Opción con vástago de acero inoxidable
Option with stainless steel stem
Longitud caño 100 mm
Spout long 100 mm



Dosificador de jabón manual *Manual soap dispenser*

Instalación bajo el mostrador *Under-counter installation*
Altura depósito 198 mm *Tank height 198 mm*
Capacidad 1.000 ml *1.000 ml capacity*

 **Ref. GW04 09 01 00**
ABS blanco *White ABS*
Polietileno *Polyethylene*



Dosificador de jabón manual *Manual soap dispenser*

Antivandálico *Vandal proof*
Capacidad 1.000 ml *1.000 ml capacity*
Encastrado bajo encimera *Undercounter soap dispenser*
Rellenado del depósito por debajo de encimera *Refill made from beneath the washbasin*

 **Ref. GW04 17 01 00**
ABS blanco *White ABS*



Dosificador de jabón manual *Manual soap dispenser*

Capacidad 1.000 ml *1.000 ml capacity*
Llave de seguridad en parte superior *Upper lock key*

 **Ref. GW04 08 01 00**
ABS blanco *White ABS*



Dosificador de jabón manual *Manual soap dispenser*

Accionamiento con el codo *Elbow operated*
Ideal para uso médico *Ideal for medical use*
Medidas 305 x 105 x 350mm *Measurements 305 x 105 x 350mm*

 **Ref. GW04 12 01 00**
ABS blanco *White ABS*
Dosificador de jabón manual
Manual soap dispenser

 **Ref. GW04 13 01 00**
Dosificador de espuma manual
Manual foam dispenser



Ref. GW04 12 01 04 
ABS plateado *ABS silver*
Dosificador de jabón manual
Manual soap dispenser



Ref. GW04 13 01 04 
ABS plateado *ABS silver*
Dosificador de espuma manual
Manual foam dispenser

Dosificador manual *Manual dispenser*

Capacidad 1.000 ml *1.000 ml capacity*
Llave de seguridad en parte superior *Upper lock key*
Medidas 245 x 115 x 110 mm *Measurements 245 x 115 x 110 mm*

 **Ref. GW04 14 01 00**
ABS blanco *White ABS*



Ref. GW04 14 01 04  
ABS plateado *ABS silver*

Dosificador de jabón automático *Automatic soap dispenser*

Capacidad 1.100 ml *1.100 ml capacity*
Funcionamiento mediante 4 pilas tipo "C" *Operated by 4 "C" type batteries*
Medidas 280 x 145 x 140 mm *Measurements 280 x 145 x 140 mm*



Ref. GW04 16 01 00
ABS blanco *White ABS*

Ref. GW13 90 01 00
Blister 4 pilas AA-LR6 KODAK Max Super
4 batteries blister AA-LR6 KODAK Max Super



NEW

Ref. GW04 16 01 03 
ABS negro *Black ABS*



NEW

Ref. GW04 16 01 04 
ABS plateado *Silver ABS*

Dosificador automático de jabón y desinfectante *Automatic soap & sanitizer dispenser*

Capacidad 1.100 ml	<i>1.100 ml capacity</i>
Dosis 1ml	<i>1ml dose</i>
Cerrado con llave de seguridad	<i>Security lock</i>
Válvula anti goteo	<i>Anti drip valve</i>
Medidas 256 x 140 x 106 mm	<i>Measurements 256 x 140 x 106 mm</i>



Ref. GW04 15 01 00
ABS blanco *White ABS*



Dosificador de líquido hidroalcohólico en spay *Spray hydroalcoholic liquid dispenser*

Capacidad 1.100 ml	<i>1.100 ml capacity</i>
Dosis 1ml	<i>1ml dose</i>
Cerrado con llave de seguridad	<i>Security lock</i>
Válvula anti goteo	<i>Anti drip valve</i>
Medidas 256 x 140 x 106 mm	<i>Measurements 256 x 140 x 106 mm</i>

Baño de gimnasio *Gym bathroom*





Accesorios de baño

Bathroom accessories

Serie completa *Full range*

13 accesorios distintos

13 accessories - No accessory missing

Ref. GW05 80 04 03 (pág. 80)

Máxima calidad *Highest quality*

Fabricado en acero inoxidable AISI 304
Manufactured in AISI 304 stainless steel

Pintado dos veces al polvo
Two times powder coated

115 micras de pintura
115 microns of paint

NIMBUS SERIES

Ref. GW05 70 04 07 (pág. 83)



Perfectamente diseñado *Perfectly designed*

Diseño redondo en acabados negro mate, dorado cepillado y metal cepillado
Rounded design in matt black, brushed gold & metal brushed finishes



Más sobre la actualidad de accesorios de baño.
More about current washroom accessories

Percha simple
Hanger

Ref. GW05 01 05 02



Accesorios de baño *Bathroom accessories*
Cartago series

Zinc cromado *Chromed zinc*



Percha doble *Double Hanger*

Ref. GW05 01 05 02B



Vaso *Tumbler holder*

Ref. GW05 02 05 02



Jabonera *Soap holder*

Ref. GW05 03 05 02



Jabonera *Soap dish*

Ref. GW05 04 05 02



Dosificador de jabón
Soap dispenser

Ref. GW05 05 05 02

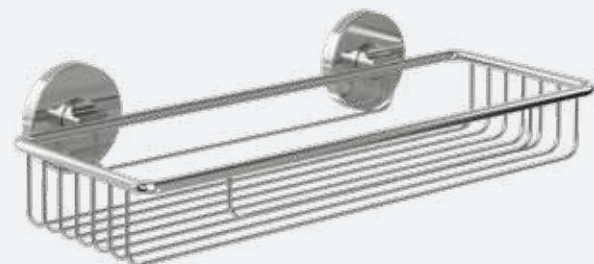

Jabonera ducha *Shower soap holder*

Ref. GW05 06 05 02



Portarrollos *Paper holder*

Ref. GW05 07 05 02



Portarrollos/Reserva
Paper holder

Ref. GW05 08 05 02



Escobillero
Toilet brush

Ref. GW05 09 05 02



Toallero barra *Towel bar*

Ref. GW05 11 05 02

Barra 580 mm *Bar 580 mm*



NEW

Toallero barra *Towel bar*

Ref. GW05 11 05 02B

Barra 450 mm *Bar 450 mm*



Toallero anilla
Towel ring

Ref. GW05 10 05 02



Repisa *Glass shelf*

Ref. GW05 13 05 02



Toallero barra doble *Double towel bar*

Ref. GW05 12 05 02

Barra doble 580 mm *Double bar 580 mm*

Percha simple *Hanger*

Ref. GW05 40 04 02B



Accesorios de baño *Bathroom accessories*
Creta series

Acero inoxidable 304 *Aisi 304 stainless steel*



Percha doble *Double hanger*

Ref. GW05 40 04 02



Vaso *Tumbler holder*

Ref. GW05 41 04 02

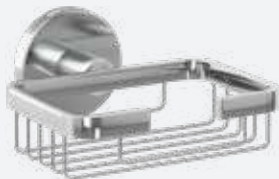

Jabonera *Soap holder*

Ref. GW05 42 04 02



Jabonera *Soap dish*

Ref. GW05 43 04 02



Dispensador jabón mural
Wall mounted soap dispenser

Ref. GW05 44 04 02

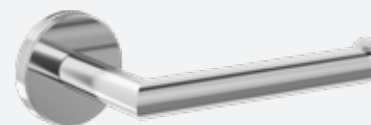

Portarrollos
Paper holder

Ref. GW05 45 04 02



Portarrollos doble
Double paper holder

Ref. GW05 46 04 02



Toallero barra *Towel bar*

Ref. GW05 49 04 02

Barra 600 mm *Bar 600 mm*



Toallero anilla *Towel ring*

Ref. GW05 47 04 02



NEW

Toallero barra *Towel bar*

Ref. GW05 49 04 02B

Barra 450 mm *Bar 450 mm*

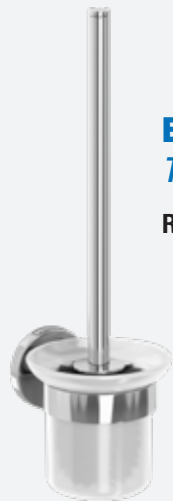

Escobillero
Toilet brush holder

Ref. GW05 48 04 02



Toallero barra doble *Double towel bar*

Ref. GW05 50 04 02



Repisa cristal *Glass shelf*

Ref. GW05 51 04 02



Toallero repisa *Towel shelf*

Ref. GW05 52 04 02

Accesorios de baño *Bathroom accessories*

Gerunda series

Acero inoxidable 304 *AISI 304 stainless steel*



Percha simple
Hanger

Ref. GW05 01 04 01B



Percha doble *Double hanger*

Ref. GW05 01 04 01



Vaso *Tumbler holder*

Ref. GW05 02 04 01



Jabonera
Soap holder

Ref. GW05 03 04 01



Jabonera *Soap dish*

Ref. GW05 04 04 01



Dosificador de jabón
Wall mounted soap dispenser

Ref. GW05 05 04 01



Portarrollos
Paper dispenser

Ref. GW05 06 04 01



Portarrollos/Reserva
Paper holder

Ref. GW05 25 04 01



Toallero barra *Towel bar*

Ref. GW05 09 04 01

Barra 575 mm *Bar 575 mm*



Escobillero *Toilet brush*

Ref. GW05 07 04 01



NEW

Toallero barra *Towel bar*

Ref. GW05 09 04 01B

Barra 450 mm *Bar 450 mm*



Toallero anilla *Towel ring*

Ref. GW05 08 04 01



Toallero barra doble *Double towel bar*

Ref. GW05 10 04 01

Barra doble 575 mm *Double bar 575 mm*



Repisa *Glass shelf*

Ref. GW05 11 04 01

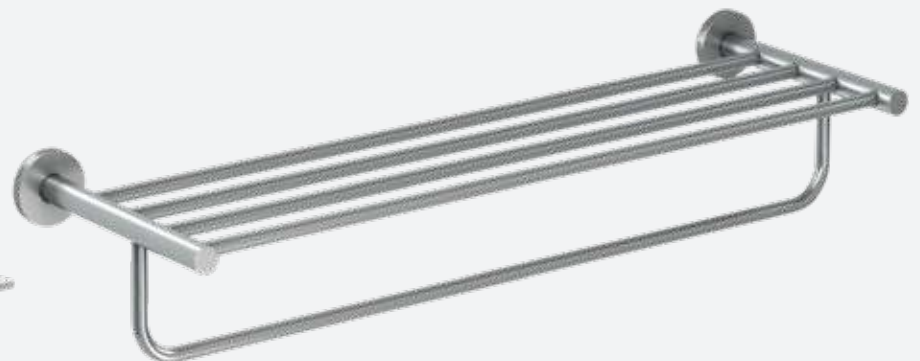

Toallero repisa *Towel shelf*

Ref. GW05 12 04 01

Accesorios de baño *Bathroom accessories*

Formentera series

Acero inoxidable 304 *AISI 304 stainless steel*



Percha simple *Hanger*

Ref. GW05 13 04 01



Percha doble *Double hanger*

Ref. GW05 13 04 01B



Vaso *Tumbler holder*

Ref. GW05 14 04 01



Jabonera *Soap holder*

Ref. GW05 15 04 01



Jabonera *Soap dish*

Ref. GW05 16 04 01



Dosificador de jabón *Wall mounted soap dispenser*

Ref. GW05 17 04 01



Portarrollos *Paper dispenser*

Ref. GW05 18 04 01



Escobillero
Toilet brush

Ref. GW05 19 04 01



Toallero barra *Towel bar*

Ref. GW05 21 04 01
Barra 575 mm *Bar 575 mm*



Toallero anilla
Towel ring

Ref. GW05 20 04 01



Toallero barra doble *Double towel bar*

Ref. GW05 22 04 01
Barra doble 575 mm *Double bar 575 mm*



Repisa *Glass shelf*

Ref. GW05 23 04 01

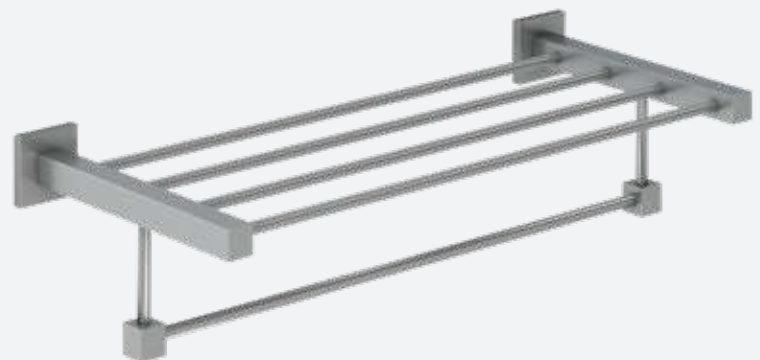

Toallero repisa *Towel shelf*

Ref. GW05 24 04 01

Accesorios de baño *Bathroom accessories*

Nimbus series

Acero 304 *304 stainless steel*



NEW
Percha simple *Hanger*

Ref. GW05 70 04 03



NEW
Percha doble
Double hanger

Ref. GW05 70 04 03B



NEW
Vaso *Tumbler holder*

Ref. GW05 71 04 03



NEW
Jabonera
Soap basket

Ref. GW05 72 04 03



NEW
Jabonera con plato
Soap dish

Ref. GW05 73 04 03



NEW
Dispensador jabón mural
Wall mounted soap dispenser

Ref. GW05 74 04 03



NEW
Jabonera ducha
Shower basket

Ref. GW05 75 04 03



NEW

Portarrollos
Paper holder

Ref. GW05 76 04 03



NEW

Portarrollos con tapa
Paper holder with lid

Ref. GW05 76 04 03B



NEW

Toallero anilla abierta *Open towel ring*

Ref. GW05 78 04 03



NEW

Portarrollos reserva
Reserve paper holder

Ref. GW05 77 04 03



NEW

Toallero barra simple *Towel bar*

Ref. GW05 80 04 03

Barra 600 mm *Bar 600 mm*



NEW

Toallero barra simple *Towel bar*

Ref. GW05 80 04 03B

Barra 450 mm *Bar 450 mm*



NEW

Escobillero
Toilet brush holder

Ref. GW05 79 04 03



NEW

Toallero repisa *Towel shelf*

Ref. GW05 81 04 03

Accesorios de baño *Bathroom accessories*

Nimbus series

Brushed metal finish

Acero 304 *304 stainless steel*

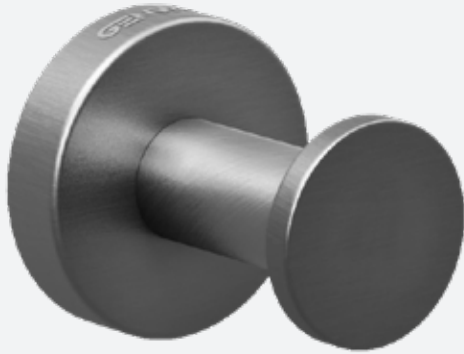

NEW

Percha simple *Hanger*

Ref. GW05 70 04 09



NEW

Percha doble
Double hanger

Ref. GW05 70 04 09B



NEW

Vaso *Tumbler holder*

Ref. GW05 71 04 09

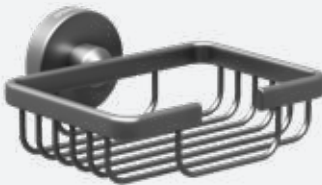

NEW

Jabonera
Soap basket

Ref. GW05 72 04 09



NEW

Jabonera con plato
Soap dish

Ref. GW05 73 04 09



NEW

Dispensador jabón mural
Wall mounted soap dispenser

Ref. GW05 74 04 09

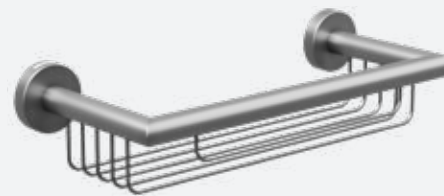

NEW

Jabonera ducha
Shower basket

Ref. GW05 75 04 09

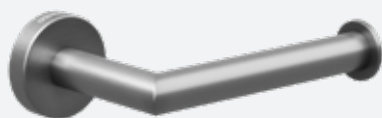

NEW

Portarrollos
Paper holder

Ref. GW05 76 04 09

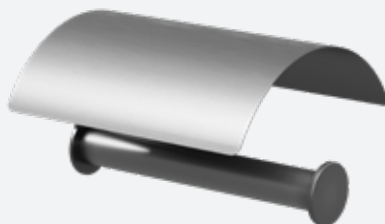

NEW

Portarrollos con tapa
Paper holder with lid

Ref. GW05 76 04 09B



NEW

Toallero anilla abierta *Open towel ring*

Ref. GW05 78 04 09



NEW

Portarrollos reserva
Reserve paper holder

Ref. GW05 77 04 09



NEW

Toallero barra simple *Towel bar*

Ref. GW05 80 04 09

Barra 600 mm *Bar 600 mm*



NEW

Toallero barra simple *Towel bar*

Ref. GW05 80 04 09B

Barra 450 mm *Bar 450 mm*



NEW

Escobillero
Toilet brush holder

Ref. GW05 79 04 09

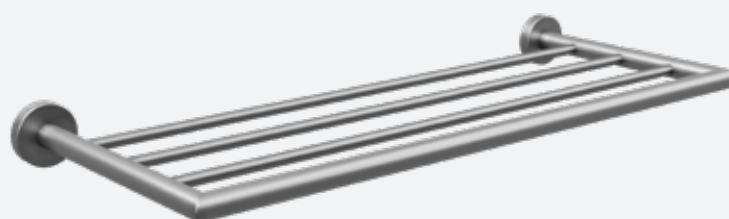

NEW

Toallero repisa *Towel shelf*

Ref. GW05 81 04 09

Accesorios de baño *Bathroom accessories*

Nimbus series

Brushed gold finish

Acero 304 *304 stainless steel*



NEW

Percha simple *Hanger*

Ref. GW05 70 04 07



NEW

Percha doble
Double hanger

Ref. GW05 70 04 07B



NEW

Vaso *Tumbler holder*

Ref. GW05 71 04 07

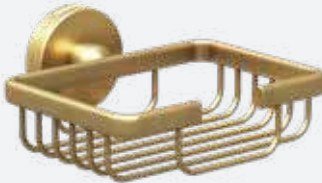

NEW

Jabonera
Soap basket

Ref. GW05 72 04 07



NEW

Jabonera con plato
Soap dish

Ref. GW05 73 04 07



NEW

Dispensador jabón mural
Wall mounted soap dispenser

Ref. GW05 74 04 07

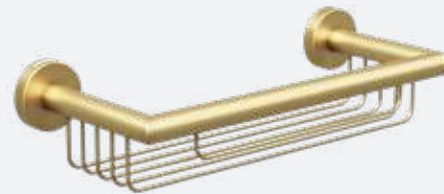

NEW

Jabonera ducha
Shower basket

Ref. GW05 75 04 07



NEW

Portarrollos
Paper holder

Ref. GW05 76 04 07



NEW

Portarrollos con tapa
Paper holder with lid

Ref. GW05 76 04 07B



NEW

Toallero anilla abierta *Open towel ring*

Ref. GW05 78 04 07



NEW

Portarrollos reserva
Reserve paper holder

Ref. GW05 77 04 07



NEW

Toallero barra simple *Towel bar*

Ref. GW05 80 04 07

Barra 600 mm *Bar 600 mm*



NEW

Toallero barra simple *Towel bar*

Ref. GW05 80 04 07B

Barra 450 mm *Bar 450 mm*



NEW

Escobillero
Toilet brush holder

Ref. GW05 79 04 07



NEW

Toallero repisa *Towel shelf*

Ref. GW05 81 04 07

Accesorios de baño *Bathroom accessories*

Pompei series

Acero inoxidable 304 *AISI 304 stainless steel*



Percha simple *Hanger*

Ref. GW05 55 04 03



Vaso *Tumbler holder*

Ref. GW05 56 04 03



Jabonera con plato
Soap dish

Ref. GW05 58 04 03



Jabonera
Soap holder

Ref. GW05 57 04 03



Jabonera ducha
Shower basket

Ref. GW05 60 04 03



Dispensador jabón mural
Wall mounted soap dispenser

Ref. GW05 59 04 03



Portarrollos
Paper holder

Ref. GW05 61 04 03



Toallero recto
Towel holder

Ref. GW05 62 04 03



Toallero barra *Towel bar*

Ref. GW05 64 04 03
Barra 570 mm *Bar 570 mm*



Escobillero
Toilet brush holder

Ref. GW05 63 04 03



Toallero barra doble *Double towel bar*

Ref. GW05 65 04 03
Barra 570 mm *Bar 570 mm*



Repisa cristal *Glass shelf*

Ref. GW05 66 04 03



Toallero repisa *Towel shelf*

Ref. GW05 67 04 03

Percha simple
Hanger

Ref. GW05 01 06 02



Accesorios de baño *Bathroom accessories*
Itálica series

Latón cromado *Chromed brass*



Vaso
Tumbler holder

Ref. GW05 02 06 02



Jabonera
Soap holder

Ref. GW05 03 06 02



Jabonera
Soap dish

Ref. GW05 04 06 02



Portarrollos
Paper dispenser

Ref. GW05 05 06 02



Portarrollos/Reserva
Paper holder

Ref. GW05 28 06 02



Toallero anilla
Towel ring

Ref. GW05 07 06 02



Escobillero
Toilet brush

Ref. GW05 06 06 02



Toallero barra *Towel bar*

Ref. GW05 08 06 02

Barra 570 mm *Bar 570 mm*



Toallero barra doble *Double towel bar*

Ref. GW05 09 06 02

Barra doble 570 mm *Double bar 570 mm*



Repisa *Glass shelf*

Ref. GW05 10 06 02

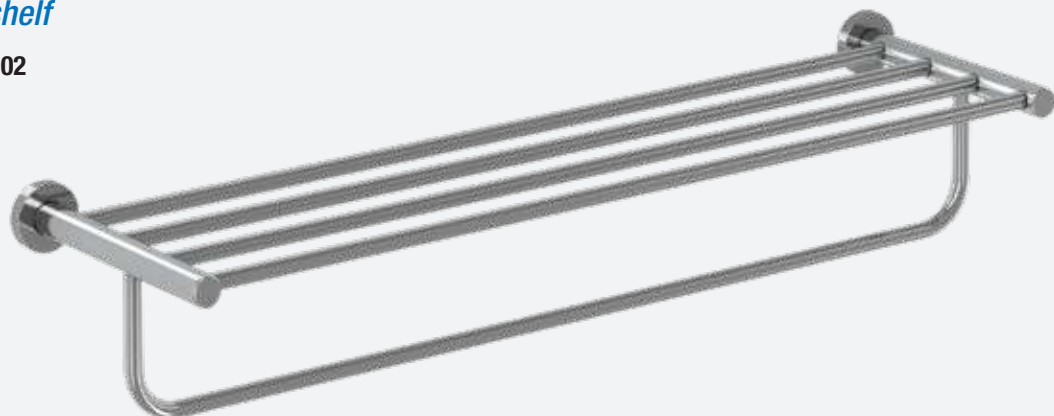

Toallero repisa *Towel shelf*

Ref. GW05 11 06 02

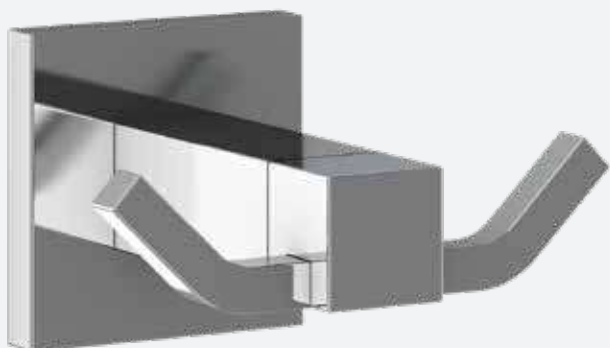

Percha doble *Double hanger*

Ref. GW05 12 06 02

Accesorios de baño *Bathroom accessories*

Lucentum series

Latón cromado *Chromed brass*

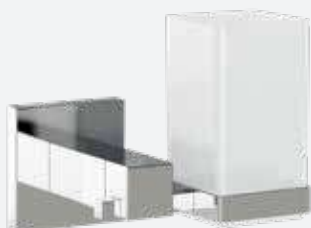

Vaso
Tumbler holder

Ref. GW05 13 06 02

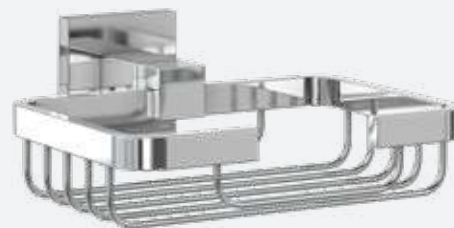

Jabonera *Soap holder*

Ref. GW05 14 06 02



Jabonera *Soap dish*

Ref. GW05 15 06 02



Portarrollos *Paper dispenser*

Ref. GW05 17 06 02



Escobillero *Toilet brush*

Ref. GW05 16 06 02



Toallero barra *Towel bar*

Ref. GW05 18 06 02

Barra 585 mm *Bar 585 mm*



Repisa *Glass shelf*

Ref. GW05 20 06 02



Toallero barra doble *Double towel bar*

Ref. GW05 19 06 02

Barra doble 585 mm *Double bar 585 mm*



Toallero repisa *Towel shelf*

Ref. GW05 21 06 02

Accesorios de baño complementarios *Complementary bathroom accessories*



NEW
Percha
Hanger

Ref. GW05 82 04 01
Acero inoxidable 304
AISI 304 Stainless steel
Satinado *Brushed*
Medidas *Measurements*
51 x 51 x 49 mm



NEW
Percha
Hanger

Ref. GW05 82 04 02
Acero inoxidable 304
AISI 304 Stainless steel
Brillante *Polished*
Medidas *Measurements*
51 x 51 x 49 mm



NEW
Percha doble
Double hanger

Ref. GW05 82 04 01B
Acero inoxidable 304
AISI 304 Stainless steel
Satinado *Brushed*
Medidas *Measurements*
51 x 100 x 52 mm



NEW
Percha doble
Double hanger

Ref. GW05 82 04 02B
Acero inoxidable 304
AISI 304 Stainless steel
Brillante *Polished*
Medidas *Measurements*
51 x 100 x 52 mm



NEW
Percha doble con tope de goma
Double coat hook with bumper

Ref. GW05 68 05 02
Zinc *Zinc*
Brillante *Polished*
Medidas *Measurements*
80 x 43 x 85 mm

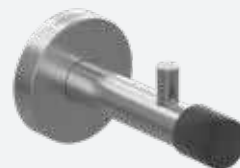

NEW
Percha con tope de goma
Coat hook with bumper

Ref. GW05 69 04 01
Acero inoxidable 304
AISI 304 Stainless steel
Satinado *Brushed*
Medidas *Measurements*
45 x 45 x 85 mm

Accesorios de baño complementarios *Complementary bathroom accessories*



NEW

Toallero cuadrado *Squared towel bar*

Ref. GW05 84 04 02
Acero inoxidable 304
AISI 304 Stainless steel
Brillante *Polished*
Medidas *Measurements*
51 x 610 x 89 mm



NEW

Toallero cuadrado *Squared towel bar*

Ref. GW05 84 04 02B
Acero inoxidable 304
AISI 304 Stainless steel
Brillante *Polished*
Medidas *Measurements*
51 x 455 x 89 mm



Manillón 135° *135° support grab bar*

Ref. GW05 22 06 02
Latón cromado *Chromed brass*
Diámetro *Tube diameter* 25 mm
Medidas *Measurements*
195 x 400 x 120 mm



Manillón 135° con jabonera *135° support grab bar with soap dish*

Ref. GW05 23 06 02
Latón cromado *Chromed brass*
Diámetro *Tube diameter* 25 mm
Medidas *Measurements*
195 x 400 x 120 mm



Barra recta 350mm *Straight bar 350mm*

Ref. GW05 34 04 02
Acero inoxidable 304
AISI 304 Stainless steel
Diámetro *Tube diameter* 25 mm
Largo *Long* 350 mm



Barra recta 500mm *Straight bar 500mm*

Ref. GW05 35 04 02
Acero inoxidable 304
AISI 304 Stainless steel
Diámetro *Tube diameter* 25 mm
Largo *Long* 500 mm

Accesorios de baño complementarios *Complementary bathroom accessories*



NEW

Jabonera cuadrada *Squared soap dish*

Ref. GW05 83 04 02

Acero inoxidable 304
AISI 304 Stainless steel

Brillante *Polished*

Medidas *Measurements*
51 x 113 x 115 mm



Jabonera rectangular *Rectangular soap dish*

Ref. GW05 24 06 02

Latón cromado *Chromed brass*

Medidas *Measurements*
70 x 255 x 128 mm

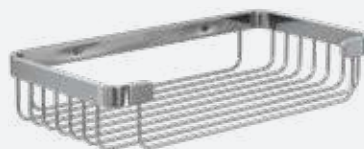

Jabonera rectangular *Rectangular soap dish*

Ref. GW05 25 04 02

Acero inoxidable 304
AISI 304 Stainless steel

Medidas *Measurements*
157 x 120 x 33.5 mm



Jabonera triangular *Triangular soap dish*

Ref. GW05 26 06 02

Latón cromado
Chromed brass

Medidas *Measurements*
55 x 295 x 205 mm

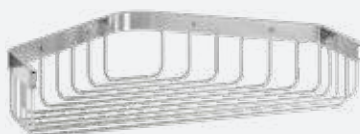

Jabonera triangular *Triangular soap dish*

Ref. GW05 27 04 02

Acero inoxidable 304
AISI 304 Stainless steel

Medidas *Measurements*
47,5 x 180 x 180 mm

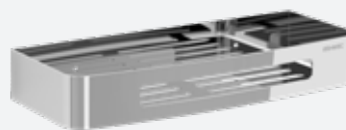

Jabonera rectangular *Rectangular soap basket*

Ref. GW05 53 04 02

Acero inoxidable 304
AISI 304 Stainless steel

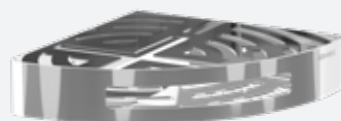

Jabonera triangular *Triangular soap basket*

Ref. GW05 54 04 02

Acero inoxidable 304
AISI 304 Stainless steel

Accesorios de baño complementarios *Complementary bathroom accessories*



Escobillero *Toilet brush*

Ref. GW05 38 04 01

Acero inoxidable 304
AISI 304 Stainless steel

Satinado *Brushed*

Medidas *Measurements*
328 x Ø 76,5 mm



NEW

Escobillero *Toilet brush*

Ref. GW05 73 04 01

Acero inoxidable 304
AISI 304 Stainless steel

Satinado *Brushed*

Medidas *Measurements*
380 x Ø 102 mm



Escobillero *Toilet brush*

Ref. GW05 28 04 02

Acero inoxidable 304
AISI 304 Stainless steel

Brillante *Polished*

Posibilidad sujeción a pared
Wall mounting included

Medidas *Measurements*
328 x Ø 76,5 mm



NEW

Escobillero *Toilet brush*

Ref. GW05 38 04 03

Acero inoxidable 304
AISI 304 Stainless steel

Negro mate *Matt black*

Medidas *Measurements*
328 x Ø 76,5 mm



Portarollos con soporte para móvi *Paper holder with mobile shelf*

Ref. GW05 37 04 02

Acero inoxidable 304
AISI 304 Stainless steel

Brillante *Polished*



Tendedor retráctil *Clothes line*

Ref. GW05 29 04 02

Acero inoxidable 304
AISI 304 Stainless steel

Longitud cuerda *Cord length* 2,75m

Medidas *Measurements*
Ø 91 x 27

Accesorios de baño complementarios *Complementary bathroom accessories*



Percha simple *Basic hanger*

Ref. GW05 33 05 01

Acero inoxidable 304
AISI 304 Stainless steel

Brillante *Polished*

Medidas *Measurements*
65 x 19 x 29 mm



NEW

Perchero 4 colgadores *4 x 1 hanger*

Ref. GW05 32 04 02

Acero inoxidable 304
AISI 304 Stainless steel

Brillante *Polished*

Medidas *Measurements*
40 x 299 x 32mm



NEW

Rodillo central para papel higiénico *Toilet roll sprindle*

Ref. GW05 74 04 01

Acero inoxidable 304
AISI 304 Stainless steel

Satinado *Brushed*

Accesorios de baño complementarios *Complementary bathroom accessories*

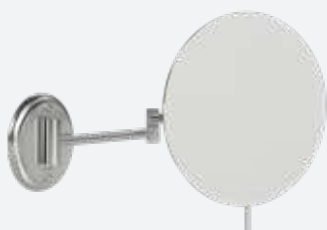

Espejo Slim redondo de aumento
Round Slim magnifying mirror

Ref. GW05 38 06 02
Latón cromado *Chromed brass*



Espejo Slim cuadrado de aumento
Square Slim magnifying mirror

Ref. GW05 39 06 02
Latón cromado *Chromed brass*



Espejo con aumento
Magnifying mirror

Ref. GW05 30 06 02
Latón cromado *Chromed brass*
Aumento *Magnifying x3*



Espejo con aumento
Magnifying mirror

Ref. GW05 30 06 03
Latón *Brass*
Negro mate *Black matt*
Aumento *Magnifying x3*



Espejo con aumento y luz LED
Magnifying mirror with LED light

Ref. GW05 31 06 02
Latón cromado *Chromed brass*
Aumento *Magnifying x3*



NEW
Espejo con aumento y luz LED
Magnifying mirror with LED light

Ref. GW05 31 06 03
Latón *Brass*
Negro mate *Black matt*
Aumento *Magnifying x3*

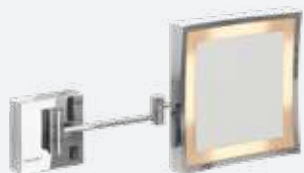

Espejo cuadrado de aumento con luz LED
Square magnifying mirror with LED light

Ref. GW05 54 06 02
Latón cromado *Chromed brass*

Baño de hotel *Hotel bathroom*





Papelera de 3 compartimientos
3 compartment bin

Reciclaje de restos, papel y envases
Waste, paper and packaging recycling

Vaciado fácil *Easy emptying*

Asas en cada contenedor para una fácil manejo
Handles on each container for easy removal



Tapa superior *Customizable top lid*

Marcada en cualquier idioma
Marked in any language

Características destacadas
Features



Reciclaje
Recycling



Capacidad
Capacity

Forma circular sin bisagras
Circular shape with no hinges

Diseño limpio y moderno
Nice clean look

Contenedores interiores resistentes al fuego
Fire resistant interior containers

Hechos en acero inoxidable
Manufactured in stainless steel

Aluminio con tratamiento anti huellas en cuerpo principal y tapa superior
Anti fingerprint aluminium main body and lid

Ref. GW06 27 02 01 (pág. 108)

Producto pensado para áreas públicas con alto tráfico de personas
Ideal product for public areas with high traffic

Aeropuertos, centros comerciales, estaciones, etc.
Airports, shopping malls, train stations, etc.



Más sobre la actualidad de papeleras.
More about current wasterpaper bins.

Papeleras

Wasterpaper bins



Ref. GW06 01 04 01 ^{3L}
 Acero inoxidable 410
AISI 410 stainless steel
 Satinado *Brushed*
 Capacidad *Capacity* 3 L
 Medidas *Measurements*
 270 x Ø 167 mm

Ref. GW06 03 04 01 ^{12L}
 Acero inoxidable 410
AISI 410 stainless steel
 Satinado *Brushed*
 Capacidad *Capacity* 12 L
 Medidas *Measurements*
 400 x Ø 248 mm

Ref. GW06 02 04 01 ^{5L}
 Acero inoxidable 410
AISI 410 stainless steel
 Satinado *Brushed*
 Capacidad *Capacity* 5 L
 Medidas *Measurements*
 284 x Ø 203 mm

Ref. GW06 04 04 01 ^{20L}
 Acero inoxidable 410
AISI 410 stainless steel
 Satinado *Brushed*
 Capacidad *Capacity* 20 L
 Medidas *Measurements*
 445 x Ø 292 mm

NEW

Ref. GW06 02 04 01T1 ^{5L}
 Acero inoxidable 410 *AISI 410 stainless steel*
 Cierre progresivo *Soft-close lid*
 Anti-huella *Fingerprint treatment*
 Pedal reforzado *Reinforced pedal*
 Satinado *Brushed*
 Medidas *Measurements* 284 x Ø 203 mm



Ref. GW06 02 04 02 ^{5L}
 Acero inoxidable 410
AISI 410 stainless steel
 Brillante *Polished*
 Capacidad *Capacity* 5 L
 Medidas *Measurements*
 284 x Ø 203 mm

Ref. GW06 04 04 02 ^{20L}
 Acero inoxidable 410
AISI 410 stainless steel
 Brillante *Polished*
 Capacidad *Capacity* 20 L
 Medidas *Measurements*
 445 x Ø 292 mm

Ref. GW06 02 03 03 ^{5L}
 Acero inoxidable 410
AISI 410 stainless steel
 Negro mate *Matt black*
 Capacidad *Capacity* 5 L
 Medidas *Measurements*
 284 x Ø 203 mm



Ref. GW06 03 04 02 ^{12L}
 Acero inoxidable 410
AISI 410 stainless steel
 Brillante *Polished*
 Capacidad *Capacity* 12 L
 Medidas *Measurements*
 400 x Ø 248 mm

Ref. GW06 03 03 03 ^{12L}
 Acero inoxidable 410
AISI 410 stainless steel
 Negro mate *Matt black*
 Capacidad *Capacity* 12 L
 Medidas *Measurements*
 400 x Ø 248 mm

Papelera *Wastepaper bin*

Cubo interior extraíble de plástico con asa *Removable interior plastic bin with handle*

40L Ref. GW06 06 04 01
Acero inoxidable 201
AISI 201 stainless steel
Satinado *Brushed*



Papelera Push Push waste bin

Capacidad 40 L *Capacity 40 L*
Medidas 740 x Ø 350 mm *Measurements 740 x Ø 350 mm*

9L Ref. GW06 07 04 01
Acero inoxidable 430
AISI 430 stainless steel
Satinado *Brushed*
Abierta *Open*



Ref. GW06 24 04 01 **9L**
Acero inoxidable 430
AISI 430 stainless steel
Satinado *Brushed*
Con tapa basculante *With tilting lid*

Papelera Wastepaper bin

Especial para habitaciones de hotel *Suitable for hotel rooms*
Capacidad 9 L *Capacity 9 L*
Medidas 300 x Ø 200 mm *Measurements 300 x Ø 200 mm*

30L Ref. GW06 10 04 02
Acero inoxidable 201
AISI 201 stainless steel
Satinado *Brushed*



Papelera con cenicero *Wastepaper bin with ashtray*

Capacidad 30 L *Capacity 30 L*
Medidas 610 x Ø 250 mm *Measurements 610 x Ø 250 mm*



Ref. GW06 12 02 01 **2,5L**
Aluminio *Aluminium*
Satinado *Brushed*

Cenicero mural *Wall mounted ashtray*

Llave de apertura inferior de seguridad *Lower opening with security key*
Capacidad 2,5 L *Capacity 2,5 L*
Medidas 480 x Ø 80 mm *Measurements 480 x Ø 80 mm*

23L Ref. GW06 14 04 01
Acero inoxidable 304
AISI 304 stainless steel
Satinado *Brushed*
Capacidad *Capacity* 23 L
Medidas *Measurements*
435 x 360 x 160 mm



Ref. GW06 14 04 03 **23L**
Acero inoxidable 304
AISI 304 stainless steel
Negro mate *Black matt*
Capacidad *Capacity* 23 L
Medidas *Measurements*
435 x 360 x 160 mm

7L Ref. GW06 13 04 01
Capacidad *Capacity* 7 L
Medidas *Measurements*
229 x 270 x 125 mm

Papelera mural *Wall mounted waste bin*



NEW

Ref. GW06 18 04 01 **20L**
Acero inoxidable 304
AISI 304 stainless steel

Papelera debajo de encimera *Under counter runner wastebin*

Railes laterales *Lateral runners with smooth sliders*
Capacidad 20 L *Capacity 20 L*
Medidas cerrado 458 x 380 x 200 mm *Closed measurements 458 x 380 x 200 mm*
Medidas abierto 458 x 380 x 495 mm *Medidas abierto 458 x 380 x 495 mm*

NEW
Ref. GW06 15 04 01
Acero inoxidable 304
AISI 304 stainless steel
Satinado *Brushed*



NEW
Ref. GW06 15 04 03
Acero inoxidable 304
AISI 304 stainless steel
Negro mate *Matt black*



Compresero mural *Wall mounted sanitary napkin bin*

Con cierre con llave en tapa inferior *Safety lock on lid below*
Medidas 280 x 200 x 98 mm *Measurements 280 x 200 x 98 mm*

10L **Ref. GW06 17 04 01**
Acero inoxidable 304
AISI 304 stainless steel
Satinado *Brushed*



Papelera mural *Wall mounted paper bin*

Tapa estilo batiente *Tilting lid*
Llave de seguridad *Security lock*
Capacidad 10 L *Capacity 10 L*

Ref. GW06 37 04 02
Acero inoxidable 304
AISI 304 stainless steel
Brillante *Polished*
Abierta *Open*



Ref. GW06 37 04 02T
Acero inoxidable 304
AISI 304 stainless steel
Brillante *Polished*
Con tapa basculante *With tilting lid*

Papelera de encimera *Counter mounted waste chute*

Medidas 90 x ø 170 mm *Measurements 90 x ø 170 mm*



NEW

Ref. GW06 25 04 01 ^{65L}
Acero inoxidable 430
AISI 430 stainless steel
Satinado *Brushed*
Capacidad *Capacity 65 L*
Medidas *Measurements*
670 x 350 x 300mm

NEW

Ref. GW06 26 04 01 ^{80L}
Acero inoxidable 430
AISI 430 stainless steel
Satinado *Brushed*
Capacidad *Capacity 80 L*
Medidas *Measurements*
820 x 350 x 300 mm

Papelera de gran capacidad *Large capacity waste bin*

Estructura antivandálica *Anti-vandalism structure*
Tapa con auto retorno *Self-closing lid*
Posibilidad sujeción a pared *Possibility to fix on wall*



Ref. GW06 19 04 01 **72L**

Acero inoxidable AISI 430

AISI 430 stainless steel

Satinado *Brushed*

Papelera de gran capacidad *Large capacity waste bin*

Papelera interior de polipropileno incluida	<i>Polypropylene liner included</i>
Estructura antivandálica con cierre frontal	<i>Anti-vandalism structure with lock on front door</i>
Tratamiento anti-huella	<i>Anti-print treatment</i>
Capacidad 72 L	<i>Capacity 72 L</i>
Medidas 860 x 520 x 515 mm	<i>Measurements 860 x 520 x 515 mm</i>



Ref. GW06 16 02 01 **50L**

Aluminio *Aluminium*

Satinado *Brushed*

Capacidad *Capacity 50 L*

Medidas *Measurements*

775 x ø 380 mm

Ref. GW06 17 02 01 **100L**

Aluminio *Aluminium*

Satinado *Brushed*

Capacidad *Capacity 100 L*

Medidas *Measurements*

830 x ø 508 mm

Papelera de gran capacidad *Large capacity waste bin*

Papelera interior de polipropileno incluida	<i>Polypropylene liner included</i>
Tratamiento anti-huella	<i>Anti-print treatment</i>



Ref. GW06 18 02 01 60L+60L

Aluminio *Aluminium*

Satinado *Brushed*

Papelera reciclaje *Recycling waste bin*

Tratamiento anti-huella	<i>Anti-print treatment</i>
2 papeleras de polipropileno 60 + 60 L	<i>2 polypropylene waste bins included 60 + 60 L</i>
Medidas 849 x ø 508 mm	<i>Measurements 849 x ø 508 mm</i>



Ref. GW06 27 02 01 67L+34L+34L

Aluminio *Aluminium*

Satinado *Brushed*

Papelera con 3 divisores para reciclaje *3 compartment recycling bin*

Cubetas interiores metálicas resistentes al fuego	<i>Fire resistant containers inside main bin</i>
Cuerpo con tratamiento anti-huella	<i>Anti-print treatment</i>
Cuerpo circular sin bisagras	<i>Circular shape without hinges</i>
Cubos interiores metálicos	<i>Metal interior liners</i>
Ideal para zonas de tráfico alto	<i>Suitable for high traffic zones</i>
Capacidad 67 + 34 + 34 L	<i>Capacity 67 + 34 + 34 L</i>
Medidas 849 x ø 508 mm	<i>Measurements 849 x ø 508 mm</i>



Ref. GW06 20 04 01 105L
 Metacrilato *Methacrylate*
 Transparente *Transparent*

Papelera transparente 3 divisores para aeropuerto *3 compartment Airport Security recycling bin*

3 divisores para reciclaje	<i>3 compartment recycling bin</i>
Capacidad de 105 L	<i>105 L capacity</i>
Espesor del metacrilato de 4 mm	<i>Methacrylate thickness 4 mm</i>
Cuerpo circular sin bisagras	<i>Circular shape without hinges</i>
Ideal para áreas de seguridad de alto tráfico	<i>Suitable for security zones with high traffic</i>



Ref. GW06 28 04 01 20L + 20L + 20L
 Acero inoxidable AISI 430
AISI 430 stainless steel
 Satinado *Brushed*

Papelera de reciclaje *Recycling waste bin*

3 compartimentos para reciclaje	<i>3 compartment for recycling</i>
Apertura frontal	<i>Front opening</i>
20 L capacidad en cada compartimento	<i>20 L capacity on each compartment</i>
Ideal para oficinas	<i>Suitable for offices</i>
Medidas 677 x 705 x 270 mm	<i>Measurements 677 x 705 x 270 mm</i>

Baño de hotel *Hotel bathroom*



Seguro Safe

Instrucciones gráficas universales
Universal instruction graphics

Mensajes de seguridad en español, inglés y francés
Safety messages in english, spanish and french



Ref. GW07 05 01 00 (pág. 113)

Higiénico Hygienic

Fabricado en polietileno con
tratamiento antimicrobiano
*Polyethylene surface with
antimicrobial additive*

Cómodo Comfortable

Mecanismo neumático de apertura/cierre
Soft open/close pneumatic mechanism

Zona de cambiado lisa y cóncava
Smooth concave changing area

Características destacadas
Features



Producto anti vandalico
Anti-vandalism product



Certificado Certificates

Unidad diseñada para ajustarse a los estándares
Unit is designed to conform to standards

EN-12221-1:2008+A1:2013,
EN-12221-2:2008+A1:2013, ATSM
2285-04, Rohs 2015/863.

Bisagras de alta resistencia en acero
Heavy duty steel hinges

Cinturón de seguridad en nylon
Security nylon strap



Más sobre la actualidad de cambiapañales.
More about current baby changing stations.

Cambiapañales *Baby changing stations*



Ref. GW07 05 01 00
 Polietileno de gran densidad
Durable high density polyethylene
 Blanco *White*



Ref. GW07 05 04 01
 Cubierta en acero inoxidable 304
Casing manufactured in AISI 304 stainless steel
 Satinado *Brushed*

Cambiapañales "Genwec Baby" *Baby changing station "Genwec Baby"*

Instalación horizontal	<i>Horizontal installation</i>
Mural	<i>Surface mounted</i>
Antibacteriano	<i>Inherently bacterial resistant</i>
Cinturón de seguridad ajustable con una mano	<i>Safety belt adjustable with one hand</i>
Fácil de limpiar	<i>Easy to clean</i>
Peso máximo recomendado de 25 Kg	<i>Maximum recommended load weight 25 Kg</i>
Medidas (abierto) 500 x 870 x 514mm	<i>Measurements (opened) 500 x 870 x 514mm</i>
Cumplimiento con normativa ASTM F2285, EN 12.221:2008 y EN 71-3:1996	<i>According to ASTM F2285, EN 12.221:2008 and EN 71-3:1995 standard</i>



Ref. GW07 02 01 00
 Polietileno de gran densidad
Durable high density polyethylene
 Blanco *White*

Cambiapañales *Baby changing station*

Instalación vertical	<i>Vertical installation</i>
Mural	<i>Surface mounted</i>
Antibacteriano	<i>Inherently bacterial resistant</i>
Cinturón de seguridad ajustable con una mano	<i>Safety belt adjustable with one hand</i>
Fácil de limpiar	<i>Easy to clean</i>
Peso máximo soportado de 22,7 Kg	<i>Supports up to 22.7 Kg</i>
Medidas (abierto) 789 x 489 x 814 mm	<i>Measurements (opened) 789 x 489 x 814 mm</i>
Cumplimiento con normativa ASTM F2285, EN 12.221:2008 y EN 71-3:1995	<i>According to ASTM F2285, EN 12.221:2008 and EN 71-3:1995 standard</i>



Ref. GW07 03 04 02 
Cubierta en acero inoxidable 304
Casing manufactured in AISI 304 stainless steel
Brillante *Polished*

Cambiapañales *Baby changing station*

Instalación horizontal	<i>Horizontal installation</i>
Mural	<i>Surface mounted</i>
Cinturón de seguridad ajustable con una mano	<i>Safety belt adjustable with one hand</i>
Fácil de limpiar	<i>Easy to clean</i>
Diseño moderno	<i>Modern design</i>
Peso máximo soportado de 22,7 Kg	<i>Supports up to 22.7 Kg</i>
Medidas (abierto) 551x 956 x 436 mm	<i>Measurements (opened) 551x 956 x 436 mm</i>
Cumplimiento con normativa ASTM F2285, EN 12.221:2008 y EN 71-3:1995	<i>According to ASTM F2285, EN 12.221:2008 and EN 71-3:1995 standard</i>



Ref. GW07 04 04 02 
Cubierta en acero inoxidable 304
Casing manufactured in AISI 304 stainless steel
Brillante *Polished*

Cambiapañales *Baby changing station*

Instalación horizontal	<i>Horizontal installation</i>
Encastrado	<i>Built-in installation</i>
Cinturón de seguridad ajustable con una mano	<i>Safety belt adjustable with one hand</i>
Fácil de limpiar	<i>Easy to clean</i>
Diseño moderno	<i>Modern design</i>
Peso máximo soportado de 22,7 Kg	<i>Supports up to 22.7 Kg</i>
Medidas (abierto) 551x 956 x 436 mm	<i>Measurements (opened) 551x 956 x 436 mm</i>
Cumplimiento con normativa ASTM F2285, EN 12.221:2008 y EN 71-3:1995	<i>According to ASTM F2285, EN 12.221:2008 and EN 71-3:1995 standard</i>



NEW

Ref. GW07 06 01 00

Polietileno de gran densidad
Durable high density polyethylene
Gris claro *Light grey*

Asiento de seguridad "Genwec baby" "Genwec Baby" child safety seat

Peso máximo soportado 25Kg	<i>Supports up to 25Kg</i>
Instalación a pared	<i>Wall mounted installation</i>
Fácil de limpiar	<i>Easy to clean</i>

Baño público *Public bathroom*





Antivandálico y resistente *Vandal proof and durable*

Fabricado en acero inoxidable AISI 304 con un espesor de 1,5mm
Manufactured in 1,5mm thickness AISI 304 stainless steel



Bordes redondeados para evitar autolesiones
Smooth and rounded corners to prevent self injury



Más sobre la actualidad de sanitarios acero inoxidable.
More about current stainless steel sanitary products.

Características destacadas
Features

Encastrada
Recessed



Sobre encimera
Countertop



Tornillos
Screws



Transmuro
Cross wall



Pedal pulsador simple
Pedal activated



Pedal pulsador doble
Double pedal activated





Unidad lista pra ser instalada
Ready to be installed



Incluye grifería, conexiones y anclajes
Tap, fittings and anchorings included



Ref. GW08 75 04 01 (pág. 129)

Sanitarios acero inoxidable
Stainless steel sanitary products

 **Ref. GW08 11 04 02**
 Sin rebosadero *Without overflow*
 Ala curvada *Curved wing*
 **Ref. GW08 12 04 02**
 Con rebosadero *With overflow*
 Ala curvada *Curved wing*



 **Ref. GW08 17 04 02**
 Sin rebosadero *Without overflow*
 Ala plana *Flat wing*
 **Ref. GW08 18 04 02**
 Con rebosadero *With overflow*
 Ala plana *Flat wing*





Diámetro exterior *Exterior diameter* 305 mm
 Diámetro interior *Interior diameter* 265 mm





Diámetro exterior *Exterior diameter* 355 mm
 Diámetro interior *Interior diameter* 315 mm

Ref. GW08 13 04 02 
 Sin rebosadero *Without overflow*
 Ala curvada *Curved wing*
Ref. GW08 14 04 02 
 Con rebosadero *With overflow*
 Ala curvada *Curved wing*

Ref. GW08 19 04 02 
 Sin rebosadero *Without overflow*
 Ala plana *Flat wing*
Ref. GW08 20 04 02 
 Con rebosadero *With overflow*
 Ala plana *Flat wing*

 **Ref. GW08 15 04 02**
 Sin rebosadero *Without overflow*
 Ala curvada *Curved wing*
 **Ref. GW08 16 04 02**
 Con rebosadero *With overflow*
 Ala curvada *Curved wing*

 **Ref. GW08 21 04 02**
 Sin rebosadero *Without overflow*
 Ala plana *Flat wing*
 **Ref. GW08 22 04 02**
 Con rebosadero *With overflow*
 Ala plana *Flat wing*



Diámetro exterior *Exterior diameter* 405 mm
 Diámetro interior *Interior diameter* 355 mm

Lavamanos esférico para encastrar *Built-in round washbasin*

1 mm acero inoxidable 304 1 mm AISI 304 stainless steel
 Brillante Polished



Ref. GW08 23 06 02
Latón cromado según UNE-EN 12165
Chrome plated brass according to UNE-EN 12165

Sifón botella para lavabo y bidé 1 1/4"
Extensible bidet and washbasin siphon 1 1/4"



Ref. GW08 24 06 02

Rebosadero latón visto 1 1/4"
External brass overflow 1 1/4"

Ref. GW08 25 04 01
1,2 mm acero inoxidable 304
1,2 mm AISI 304 stainless steel
Satinado *Brushed*
Medidas *Measurements*
210 x 365 x 362 mm



Ref. GW08 27 04 01 
1 mm acero inoxidable 304
1 mm AISI 304 stainless steel
Satinado *Brushed*
Instalación transmuro
Cross wall installation
Medidas *Measurements*
440 x 352 x 425 mm

Lavamanos mural redondo *Round wall hung washbasin*

Ref. GW08 26 04 01
1,5 mm acero inoxidable 304
1,5 mm AISI 304 stainless steel
Satinado *Brushed*



Lavamanos esquinero redondo *Lavamanos esquinero redondo*

Medidas 210 x 230 x 325 mm *Measurements 210 x 230 x 325 mm*



Ref. GW08 72 04 01 
1,2mm acero inoxidable AISI 304
1,2mm AISI 304 stainless steel
Interior brillante *Polished interior*
Exterior satinado *Brushed exterior*

Lavamanos sobre encimera redondo *Countertop rounded washbasin*

Adecuado para grifo mural o alto *Suited for wall mounted or extended tap*
Incluye desagüe 1 ¼" *1 ¼" waste included*
Medidas 165 x ø 375 mm *Measurements 165 x ø 375 mm*



Ref. GW08 53 04 01 
1,2mm acero inoxidable AISI 304
1,2mm AISI 304 stainless steel
Satinado *Brushed*

Lavamanos sobre encimera *Countertop washbasin*

Incluye desagüe 1 ¼" *1 ¼" waste included*
Medidas 80 x 395 x 400 mm *Measurements 80 x 395 x 400 mm*

 **Ref. GW08 54 04 01**
1,5mm acero inoxidable AISI 304
1,5mm AISI 304 stainless steel
Satinado *Brushed*



Lavamanos a pared con desagüe oculto *Wall mounted washbasin with concealed drain*

Diseño elegante con desagüe oculto *Stylish design with concealed drain*
Incluye desagüe 1 ¼" y fijaciones *1 ¼" waste and fixing brackets included*
Medidas 115 x 700 x 440 mm *Measurements 115 x 700 x 440 mm*



Ref. GW08 40 04 01

Con peto *With backsplash*

Medidas *Measurements*

390 x 600 x 500 mm

Ref. GW08 43 04 01

Con peto *With backsplash*

Medidas *Measurements*

390 x 1.800 x 500 mm

Ref. GW08 41 04 01

Con peto *With backsplash*

Medidas *Measurements*

390 x 1.200 x 500 mm

Ref. GW08 44 04 01

Con peto *With backsplash*

Medidas *Measurements*

390 x 2.400 x 500 mm

Ref. GW08 42 04 01

Con peto *With backsplash*

Medidas *Measurements*

390 x 1.500 x 500 mm



Ref. GW08 46 04 01

Con y Sin peto

With and without backsplash

Juego patas de soporte (2 unidades)

Support legs (2 units)

Medidas *Measurements* 800 x 55 x 55 mm

Ref. GW08 35 04 01

Sin peto *Without backsplash*

Medidas *Measurements*

131 x 600 x 500 mm

Ref. GW08 38 04 01

Sin peto *Without backsplash*

Medidas *Measurements*

131 x 1.800 x 500 mm

Ref. GW08 36 04 01

Sin peto *Without backsplash*

Medidas *Measurements*

131 x 1.200 x 500 mm

Ref. GW08 39 04 01

Sin peto *Without backsplash*

Medidas *Measurements*

131 x 2.400 x 500 mm

Ref. GW08 37 04 01

Sin peto *Without backsplash*

Medidas *Measurements*

131 x 1.500 x 500 mm



Ref. GW08 45 04 01

Sin peto *Without backsplash*

Juego escuadras de soporte (2 unidades)

Wall frame supports (2 units)



Lavamanos colectivo *Collective washbasin*

1 mm acero inoxidable 304

Satinado

Opción patas / escuadras

1 mm AISI 304 stainless steel

Brushed

Optional legs / wall frame support

➡ **Ref. GW08 47 04 01**
1,2 mm acero inoxidable 304
1,2 mm AISI 304 stainless steel
Satinado *Brushed*
Medidas *Measurements*
1020 x 700 x 475 mm

➡ **Ref. GW08 48 04 01**
Medidas *Measurements*
1020 x 1400 x 475 mm

➡ **Ref. GW08 49 04 01**
Medidas *Measurements*
1020 x 2100 x 475 mm



Lavamanos mural quirúrgico *Wall mounted surgical washbasin*

Peto de 450 mm	<i>450 mm wall stand</i>
Superficie lisa y cantos redondeados	<i>Smooth surface with rounded edges</i>
Con desagüe	<i>With drainage</i>
Sin rebosadero	<i>Without overflow</i>
Suministrado con todos los elementos de fijación	<i>Supplied with all fixing elements</i>

 Ref. GW08 50 04 01

Pulsador con mezclador de agua fría y caliente
Pushbutton with cold and hot water mixer



Ref. GW08 51 04 01 

Doble pulsador, agua fría y caliente
Two pushbuttons, cold and hot water



Lavamanos registrable con pedestal *Pedal operated washbasin*

Medidas 850 x 450 x 450 mm *Measurements 850 x 450 x 450 mm*

 Ref. GW08 52 04 01



Lavamanos mural activado con rodilla *Wall mounted knee operated washbasin*

Medidas 215 x 450 x 450 mm *Measurements 215 x 450 x 450 mm*



Ref. GW08 84 04 01 

1mm acero inoxidable AISI 304
1mm AISI 304 stainless steel
Pulido *Polished*

Fregadero a pared *Wall mounted sink*

Incluye todos los elementos de fijación *All fixing elements included*
Medidas 250 x 600 x 500 mm *Measurements 250 x 600 x 500 mm*



Ref. GW08 55 04 01 
 1,5 mm acero inoxidable 304
 1,5 mm AISI 304 stainless steel
 Satinado *Brushed*
 Inodoro instalado a suelo,
 salida pared
*Floor installed toilet,
 wall outlet*

Ref. GW08 56 04 01 
 Inodoro instalado a suelo,
 salida a suelo
*Floor installed toilet,
 floor outlet*

Inodoro instalado a suelo *Floor installed toilet*

Inodoro anti vandálico *Anti-vandalism toilet*
 Para uso con fluxómetro
 o cisterna encastrada *Water discharge with fluxmeter
 or built-in tank*
 Medidas 400 x 353 x 600 mm *Measurements 400 x 353 x 600 mm*



Ref. GW08 57 04 01 
 1,5 mm acero inoxidable 304
 1,5 mm AISI 304 stainless steel
 Satinado *Brushed*

Inodoro suspendido a pared *Wall mounted toilet*

Inodoro anti vandálico *Anti-vandalism toilet*
 Para uso con fluxómetro
 o cisterna encastrada *Water discharge with fluxmeter
 or built-in tank*
 Medidas 350 x 353 x 515 mm *Measurements 350 x 353 x 515 mm*

Ref. GW08 70 01 00



Tapa de PVC *PVC cover*

Para ref. GW08 55, GW08 56, GW08 57
For ref. GW08.55, GW08 56, GW08 57



Ref. GW08 58 04 01 
 1,5 mm acero inoxidable 304
 1,5 mm AISI 304 stainless steel
 Satinado *Brushed*

Inodoro con cisterna de descarga
Toilet with discharge tank

Con una salida de agua *With one water outlet*
 Medidas 710 x 353 x 600 mm *Measurements 710 x 353 x 600 mm*



Ref. GW08 59 04 01

1 mm acero inoxidable 304
1 mm AISI 304 stainless steel
Satinado *Brushed*

Placa turca *Squat toilet*

Con una salida de agua *With one water outlet*
Medidas 500 x 600 mm *Measurements 500 x 600mm*



Ref. GW08 60 04 01

1,5 mm acero inoxidable 304
1,5 mm AISI 304 stainless steel
Satinado *Brushed*

Inodoro instalado a suelo *Floor installed toilet*

Urinario redondo *Rounded urinal*
Medidas 570 x 365 x 315 mm *Measurements 570 x 365 x 315 mm*



Ref. GW08 61 04 01

1,5 mm acero inoxidable 304
1,5 mm AISI 304 stainless steel
Satinado *Brushed*

Urinario mural *Wall hung urinal*

Medidas 256 x 342 x 490 mm *Measurements 256 x 342 x 490 mm*



Ref. GW08 86 04 01

1,5mm acero inoxidable AISI 304
1,5mm AISI 304 stainless steel
Satinado *Brushed*

Separador de urinario *Urinal divider*

Superficie lisa con bordes redondeados *Smooth surface and rounded edges*
Medidas 950 x 80 x 400 mm *Measurements 950 x 80 x 400 mm*

- Ref. GW08 62 04 01**
 1,2 mm acero inoxidable 304
1,2 mm AISI 304 stainless steel
 Satinado *Brushed*
 Medidas *Measurements*
 600 x 1.200 x 300 mm
- Ref. GW08 63 04 01**
 Medidas *Measurements*
 600 x 1.800 x 300 mm
- Ref. GW08 64 04 01**
 Medidas *Measurements*
 600 x 2.400 x 300 mm



Urinario colectivo pared *Wall mounted collective urinal*



- Ref. GW08 90 04 01** 
 1,2mm acero inoxidable AISI 304
1,2mm AISI 304 stainless steel
 Satinado *Brushed*

Lavabo antivandálico transmuro *Vandal proof cross wall installed washbasin*

- | | |
|--|---|
| <p>Antivandálico</p> | <p><i>Vandal proof</i></p> |
| <p>Totalmente cerrado con desagüe oculto</p> | <p><i>Shrouded basin with concealed drain</i></p> |
| <p>Incluye grifo temporizado a prueba de manipulaciones</p> | <p><i>Tamper proof timed tap included</i></p> |
| <p>Incluye todos los elementos de fijación</p> | <p><i>All fixing elements included</i></p> |
| <p>Medidas 350 x 400 x 280 mm</p> | <p><i>Measurements 350 x 400 x 280 mm</i></p> |

- 
Ref. GW08 73 04 01
 1,5 mm acero inoxidable 304
1,5 mm AISI 304 stainless steel
 Satinado *Brushed*
 Inodoro a la derecha *Right angle toilet*
- 
Ref. GW08 74 04 01
 Inodoro a la izquierda *Left angle toilet*
- 
Ref. GW08 75 04 01
 Inodoro centrado *Centered toilet*



Compacto de lavabo e inodoro antivandálico *Anti-vandalism urinal and washbasin set*

Incluye grifería, conexiones y anclajes *Tap, connections and anchorings included*

- 
Ref. GW08 70 04 02
 1mm acero inoxidable AISI 304
1 mm AISI 304 stainless steel
 Pulido *Polished*
 Medidas *Measurements*
 610 x 400 x 20 mm



Espejo antivandálico *Vandal proof mirror*

Sin cristal *No crystal*
 Totalmente de acero inoxidable *Fully stainless steel*
 Incluye todos los elementos de fijación *All fixing elements included*

- 
Ref. GW08 71 04 02
 Medidas *Measurements*
 900 x 600 x 20 mm



- Ref. GW08 68 04 01**
 1 mm acero inoxidable 304
1 mm AISI 304 stainless steel
 Satinado *Brushed*
 Medidas *Measurements*
 65 x 700 x 700 mm

- Ref. GW08 69 04 01**
 Medidas *Measurements*
 80 x 800 x 800 mm

Plato de ducha *Built-in shower pan*

Desagüe mediante válvula de PVC *Drainage with PVC valve*





Baño público *Public bathroom*

Ref. GW09 02 04 01 (pág. 134)

Unidades todo en uno para una optimización del espacio
All-in-one units for space optimization

Características destacadas *Features*

-  Producto anti vandálico
Anti-vandalism product
-  Encastrado
Built-in installation
-  Mural
Surface mounted

Diferentes opciones con instalación
a superficie o encastrada
*Several solutions with surface
installation or built in.*

Ref. GW09 08 04 01 (pág. 134)



Unidades completamente antivandálicas
fabricadas en acero inoxidable AISI 304
*Vandal proof units manufactured in AISI
304 stainless steel*



Más sobre la actualidad de muebles compactos.
More about current compact furniture.

Muebles compactos
Compact furniture



Ref. GW09 01 04 01

Acero inoxidable 304, espesor 0,8 mm
0.8 mm AISI 304 stainless steel

Satinado *Brushed*

Encastrado *Built-in installation*

Medidas *Measurements*

1.650 x 370 x 160 mm

Medidas hueco *Wall hole measurements*

1.620 x 330 x 170 mm



Ref. GW09 07 04 01

Acero inoxidable 304, espesor 0,8 mm
0.8 mm AISI 304 stainless steel

Satinado *Brushed*

Mural *Surface mounted*

Medidas *Measurements*

1.650 x 370 x 160 mm

Dispensador de toallas, secamanos y papelera *Paper towel dispenser, hand dryer & wastepaper bin*

Capacidad de 600-800 papeles toalla *600-800 papel towel capacity*
Secadora de manos de 2.500 W automático *2,500 W automatic hand dryer*
Papelera 28 litros *28 liter bin capacity*

Características técnicas *Technical features*



Voltaje <i>Voltage</i>	220 - 240 V	Consumo <i>Power consumption</i>	10,8 A
Frecuencia <i>Frequency</i>	50 / 60 Hz	Aislamiento eléctrico <i>Electrical insulation</i>	Class I
Velocidad aire <i>Air speed</i>	108 Km/h	Protección <i>Protection level</i>	IPX1
Caudal aire <i>Airflow</i>	270 m ³ /h 4.500 l/min	Peso <i>Weight</i>	21 Kg
Temperatura aire <i>Air temperature</i>	45°C	Tiempo de secado <i>Drying time</i>	15"
Potencia total <i>Total power</i>	2.400 W	Sonoridad a 2 m <i>Sound level at 2 m</i>	74 dB
Potencia resistencia <i>Power of heating element</i>	2.100 W	rpm <i>rpm</i>	8.200
Potencia motor <i>Motor power</i>	300 W	Desconexión anti vandálica <i>Automatic shut-off</i>	60"



Ref. GW09 02 04 01

Acero inoxidable 304, espesor 0,8 mm

0.8 mm AISI 304 stainless steel

Satinado *Brushed*

Encastrado *Built-in installation*

Medidas *Measurements*

1.300 x 370 x 160 mm

Medidas hueco *Wall hole measurements*

1.270 x 330 x 170 mm



Ref. GW09 02 04 01FL

Acero inoxidable 304, espesor 0,8 mm

0.8 mm AISI 304 stainless steel

Satinado *Brushed*

Encastrado *Built-in installation*

Opción sin marcos *No frames*

Medidas *Measurements*

1.300 x 370 x 160 mm

Medidas hueco *Wall hole measurements*

1.270 x 330 x 170 mm



Ref. GW09 02 04 01H1

Acero inoxidable 304, espesor 0,8 mm

0.8 mm AISI 304 stainless steel

Satinado *Brushed*

Encastrado *Built-in installation*

Opción sin marcos *No frames*

Medidas *Measurements*

700 x 370 x 100 mm

Medidas hueco *Wall hole measurements*

670 x 330 x 110 mm



Ref. GW09 08 04 01

Acero inoxidable 304, espesor 0,8 mm

0.8 mm AISI 304 stainless steel

Satinado *Brushed*

Mural *Surface mounted*

Medidas *Measurements*

1.250 x 350 x 140 mm

Dispensador de toallas y papelera Paper towel dispenser & bin

Capacidad de 600-800 papeles toalla

600-800 papel towel capacity

Papelera 23 litros

23 liter bin capacity



Ref. GW09 03 04 01

Acero inoxidable 304, espesor 0,8 mm
0.8 mm AISI 304 stainless steel

Satinado *Brushed*

Encastrado *Built-in installation*

Medidas *Measurements*

530 x 370 x 140 mm

Medidas hueco *Wall hole measurements*

485 x 330 x 150 mm



Ref. GW09 09 04 01

Acero inoxidable 304, espesor 0,8 mm
0.8 mm AISI 304 stainless steel

Satinado *Brushed*

Mural *Surface mounted*

Medidas *Measurements*

530 x 350 x 140 mm

Dispensador de papel toalla *Paper towel dispenser*

Capacidad de 600-800 papeles toalla *600-800 paper towel capacity*



Ref. GW09 11 04 01

Acero inoxidable 304, espesor 0,8 mm
0.8 mm AISI 304 stainless steel

Satinado *Brushed*

Encastrado *Built-in installation*

2.500 W automático

2,500 W automatic

Con escobillas

With brushes

Medidas *Measurements*

650 x 350 x 180 mm

Medidas hueco *Wall hole measurements*

620 x 300 x 165 mm



Ref. GW09 13 04 01

Acero inoxidable 304, espesor 0,8 mm
0.8 mm AISI 304 stainless steel

Satinado *Brushed*

Mural *Surface mounted*

2.500 W automático

2,500 W automatic

Con escobillas

With brushes

Medidas *Measurements*

530 x 350 x 140 mm



Ref. GW09 12 04 01

800 W automático

800 W automatic

Sin escobillas

Brushless

Secamanos *Hand dryer*



Ref. GW09 14 04 01

Acero inoxidable 304, espesor 0,8 mm
0.8 mm AISI 304 stainless steel

Satinado *Brushed*

Encastrado *Built-in installation*

Medidas *Measurements*
690 x 410 x 170 mm

Medidas hueco *Wall hole measurements*
650 x 370 x 160 mm



Ref. GW09 15 04 01

Acero inoxidable 304, espesor 0,8 mm
0.8 mm AISI 304 stainless steel

Satinado *Brushed*

Semi-encastrada *Semi-recessed*

Medidas *Measurements*
690 x 410 x 169 mm

Medidas hueco *Wall hole measurements*
650 x 370 x 94 mm

Papelera *Wastepaper bin*

Capacidad de 600-800 papeles toalla *600-800 papel towel capacity*





Baño público *Public bathroom*

Fuentes de agua

Water dispensers

Resistente y antivandálica
Durable and vandal proof

Fabricada en acero inoxidable AISI 304. Interiormente y exteriormente
Fully AISI 304 stainless steel. Inside and outside

10 años de garantía
10 years warranty



Diseñada para el alto tráfico
Designed for high traffic zones

Capacidad de refrigeración de 35l/h
Cooling capacity up to 35l/h

Velocidad flujo agua 60l/h
Water flux speed up to 60l/h

Incluye rellenador botellas
Bottle filler included

La mejor opción para centros deportivos
Best choice for sports centres



Más sobre la actualidad de fuentes de agua.
More about current water dispensers.



Altamente eficiente.
Sólo consume 200W
*Highly efficient. 200W
power consumption*

Ajustable Flexible
Fácil regulación de la temperatura
del agua (termostato) 4-11°C
*Easily setting of the water
temperature (thermostat) 4-11°C*



Ref. GW10 01 04 02 (pág. 142)

Totalmente higiénica Maximum hygiene
Se activa mediante pedal
Pedal operated
Incluye protección para evitar el contacto del
surtidor con la boca del usuario
*Guard included to prevent contact between
spigot and user's mouth*

NEW

Ref. GW10 06 04 02
Acero inoxidable 304
AISI 304 stainless steel



Fuente mural con cumplimiento ADA *ADA design wall mounted water dispenser*

Instalación mural	<i>Wall mounted</i>
Cumple con normativa ADA	<i>ADA compliant</i>
Sistema refrigeración incluido	<i>Refrigeration system included</i>
Acceso fácil e inclusivo	<i>Inclusive & accessible</i>

Características técnicas *Technical features*

Voltaje <i>Voltage</i>	220 - 240 V	Temperatura agua <i>Water output temperature</i>	3-10 °C
Frecuencia <i>Frequency</i>	50 / 60 Hz	Gas refrigerante ecológico <i>Refrigerant gas</i>	R 134 A
Potencia frigorífica <i>Cooling power</i>	350 W	Frío mediante depósito <i>Water tank capacity</i>	4 l/h
Capacidad de frío <i>Cooling capacity</i>	25 l/h	Peso <i>Weight</i>	20 kg
Velocidad salida del agua <i>Water flux speed</i>	60 l/h	Garantía (años) <i>Warranty (years)</i>	2



Ref. GW10 01 04 02
 Interior y exterior fabricados
 en acero inoxidable 304
Fully AISI 304 material
(exterior and interior)

Fuente de pie activada por pedal, con rellenavasos *Floor standing pedal operated water dispenser with cup-filler*

Instalación de pie	<i>Floor mounted</i>
Sistema de refrigeración incluido	<i>Refrigeration system included</i>
Temperatura del agua fácilmente regulable	<i>Easily regulated water temperature (thermostat)</i>

Características técnicas *Technical features*

Voltaje <i>Voltage</i>	220 - 240 V	Temperatura agua <i>Water output temperature</i>	4-11 °C
Frecuencia <i>Frequency</i>	50 / 60 Hz	Gas refrigerante ecológico <i>Refrigerant gas</i>	R 134 A
Potencia frigorífica <i>Cooling power</i>	400 W	Frío mediante depósito <i>Water tank capacity</i>	4,5 l
Consumo <i>Power consumption</i>	200 W	Peso <i>Weight</i>	26 kg
Capacidad de frío <i>Cooling capacity</i>	35 l/h	Garantía (años) <i>Warranty (years)</i>	10
Velocidad salida del agua <i>Water flux speed</i>	60 l/h		

Ref. GW10 02 04 02
 Interior y exterior fabricados
 en acero inoxidable 304
Fully AISI 304 material
(exterior and interior)



Fuente mural activada por pulsador *Wall mounted push button operated cold water dispenser*

Instalación mural	<i>Wall mounted</i>
Sistema de refrigeración incluido	<i>Refrigeration system included</i>
Temperatura del agua fácilmente regulable	<i>Easily regulated water temperature (thermostat)</i>

Características técnicas *Technical features*

Voltaje <i>Voltage</i>	220 - 240 V	Temperatura agua <i>Water output temperature</i>	4-11 °C
Frecuencia <i>Frequency</i>	50 / 60 Hz	Gas refrigerante ecológico <i>Refrigerant gas</i>	R 134 A
Potencia frigorífica <i>Cooling power</i>	350 W	Frío mediante depósito <i>Water tank capacity</i>	4,5 l
Consumo <i>Power consumption</i>	200 W	Peso <i>Weight</i>	23 kg
Capacidad de frío <i>Cooling capacity</i>	30 l/h	Garantía (años) <i>Warranty (years)</i>	10
Velocidad salida del agua <i>Water flux speed</i>	60 l/h		



Ref. GW10 03 04 02

Exterior fabricado en
acero inoxidable 304
Fully AISI 304 material (exterior)

Interior de acero con
tratamiento anti-corrosivo
*Steel interior with
anti-corrosion treatment*

Con rellenavaso *With cup-filler*

Ref. GW10 14 04 02

Exterior fabricado en
acero inoxidable 304
Fully AISI 304 material (exterior)

Interior de acero con
tratamiento anti-corrosivo
*Steel interior with
anti-corrosion treatment*

Sin rellenavaso *Without cup-filler*

Fuente de pie *Floor standing water dispenser*

Instalación de pie *Floor mounted*
Sistema de refrigeración incluido *Refrigeration system included*
Temperatura del agua fácilmente regulable *Easily regulated water temperature (thermostat)*

Características técnicas *Technical features*

Voltaje <i>Voltage</i>	220 - 240 V	Temperatura agua <i>Water output temperature</i>	4-11 °C
Frecuencia <i>Frequency</i>	50 / 60 Hz	Gas refrigerante ecológico <i>Refrigerant gas</i>	R 134 A
Potencia frigorífica <i>Cooling power</i>	400 W	Frío mediante depósito <i>Water tank capacity</i>	4,5 l
Consumo <i>Power consumption</i>	200 W	Peso <i>Weight</i>	26 kg
Capacidad de frío <i>Cooling capacity</i>	35 l/h	Garantía (años) <i>Warranty (years)</i>	10
Velocidad salida del agua <i>Water flux speed</i>	60 l/h		



Ref. GW10 04 04 02
Acero inoxidable 304, 2 mm de grosor
2 mm thickness 304 stainless steel

Fuente de pie exterior activada por pulsador *Outdoor floor standing push button operated water dispenser*

Especialmente diseñada para exterior	<i>Specially designed for outdoor use</i>
Sin refrigeración	<i>Without refrigeration unit</i>
Activada por pulsador	<i>Operated by push button</i>

Ref. GW10 01 90 00
Recambio rellena vasos
Glass filler spare part



Ref. GW10 01 90 01
Recambio pulsador
Push button spare part



Ref. GW10 06 01 00
Filtro opcional de plástico
GW10 01 y GW10 02
*Optional plastic filter for
GW10 01 and GW10 02*

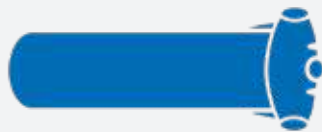

Ref. GW10 07 01 00
Cartucho recambio para filtros
GW10 05 y GW10 06
*Replacement cartridge for filters
GW10 05 and 10 06*

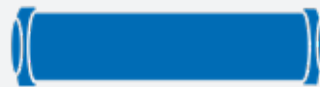

Ref. GW10 08 01 00
Filtro opcional para GW10 03
Optional filter for GW10 03

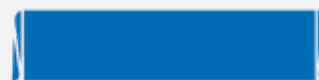



Baño de gimnasio *Gym washroom*



Ayudas técnicas a la movilidad

Grab bars & technical mobility supports

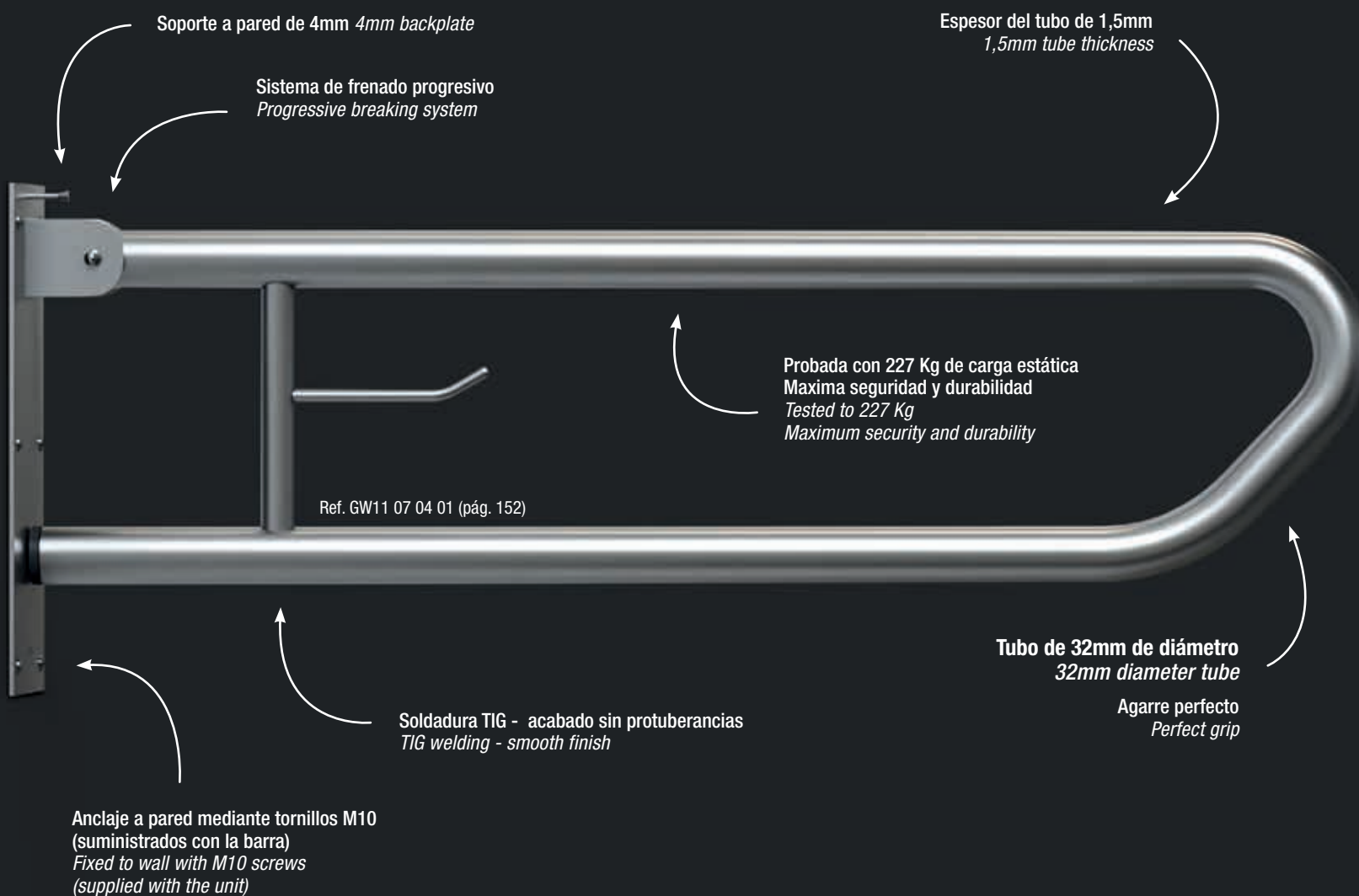

Más sobre la actualidad de ayudas técnicas a la movilidad.
More about current grab bars & technical mobility supports.

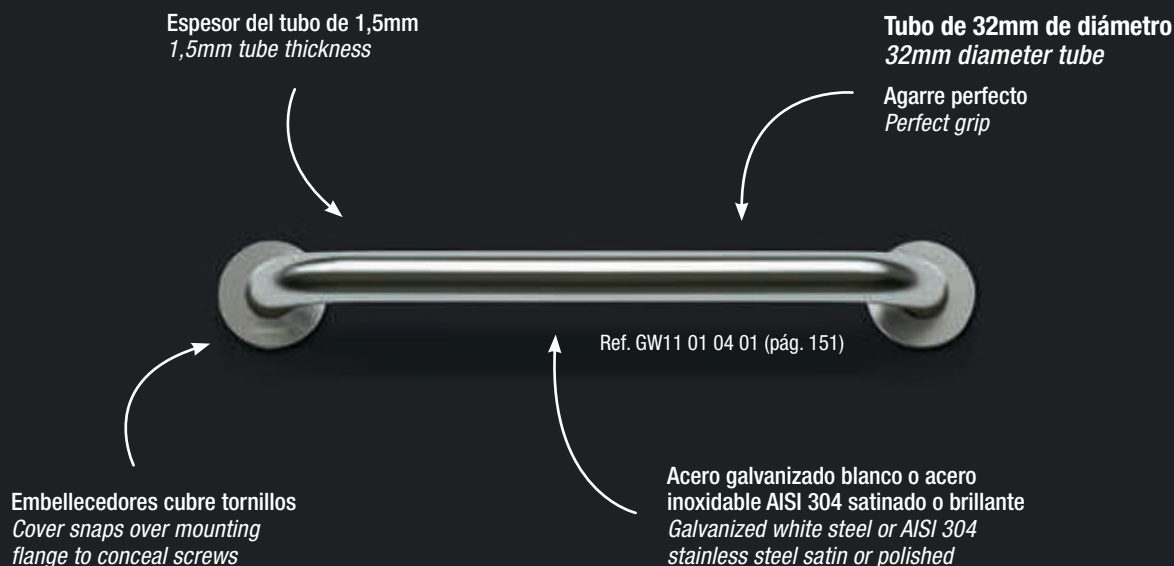

Características generales de barras en acero y acero inoxidable 304 General characteristics of AISI 304 stainless steel and steel bars

Todas las barras están fabricadas en acero (pintado en epoxi) o acero inoxidable 304 garantizando alta resistencia a la corrosión
All bars are manufactured in steel (epoxy painted) or AISI 304 stainless steel which guarantees high resistance to corrosion

Modelos de acero pintado en epoxi incluyen tratamiento antioxidante
Epoxy white steel models include special treatment against corrosion

Todas las barras en acero y acero inoxidable tienen un diámetro de 32 mm
All steel and stainless steel bars have a diameter of 32 mm

El tubo de acero o acero inoxidable dispone de un espesor de 1,5 mm
The steel or stainless steel tube has a thickness of 1.5 mm

Todas las barras incluyen florones embellecedores para su montaje oculto
All the bars include flange covers for hidden mounting

Tornillería de acero inoxidable incluida
Stainless steel nuts and bolts included

El proceso de doblado asegura la uniformidad de las curvas
Bending process ensures the uniformity on the curves

Todas las barras están disponibles en acero inoxidable 316 bajo pedido
All bars are available in AISI 316 stainless steel on request

Posibilidad de fabricación a medida bajo pedido en todos los modelos de barras
Possibility of measurements made to order for all bar models, on request

Denominación izquierda o derecha mirando las barras de frente, no en la posición de usuario
Bar position left/ right facing the bar, not in the position of the user

Características generales de barras de nylon General characteristics of nylon bars

Todas las barras tienen un diámetro de 35 mm
All bars have a diameter of 35 mm

El tubo de nylon dispone de un espesor de 5 mm
The nylon tube has a thickness of 5 mm

Todas las barras incluyen flores embellecedoras para su montaje oculto
All the bars include flange covers for hidden mounting

Tornillería de acero incluida
Stainless steel nuts and bolts included

Material antibacteriológico, anticonductivo y antideslizante
Antibacterial, anti conductive and antislip material

Posibilidad de fabricación a medida y elección de colores bajo pedido
Possibility of made to order measurements and colours on request



Acero inoxidable 304 *AISI 304 stainless steel*
Satinado *Brushed*

Largo <i>Long</i>	Ref.	Largo <i>Long</i>	Ref.
300 mm	Ref. GW11 01 04 01	750 mm	Ref. GW11 04 04 01
400 mm	Ref. GW11 02 04 01	900 mm	Ref. GW11 05 04 01
600 mm	Ref. GW11 03 04 01	1.200 mm	Ref. GW11 06 04 01

NEW

Acero inoxidable 201 *AISI 201 stainless steel*
Negro mate *Matt black*

Largo <i>Long</i>	Ref.
400 mm	Ref. GW11 02 04 03
600 mm	Ref. GW11 03 04 03
750 mm	Ref. GW11 04 04 03



Acero inoxidable 201 *AISI 201 stainless steel*
Epoxi blanco *White epoxy*

Largo <i>Long</i>	Ref.	Largo <i>Long</i>	Ref.
300 mm	Ref. GW11 01 03 00	750 mm	Ref. GW11 04 03 00
400 mm	Ref. GW11 02 03 00	900 mm	Ref. GW11 05 03 00
600 mm	Ref. GW11 03 03 00	1.200 mm	Ref. GW11 06 03 00



Acero inoxidable 304 *AISI 304 stainless steel*
Brillante *Polished*

Largo <i>Long</i>	Ref.	Largo <i>Long</i>	Ref.
300 mm	Ref. GW11 01 04 02	750 mm	Ref. GW11 04 04 02
400 mm	Ref. GW11 02 04 02	900 mm	Ref. GW11 05 04 02
600 mm	Ref. GW11 03 04 02	1.200 mm	Ref. GW11 06 04 02



Barra recta *Grab bar*

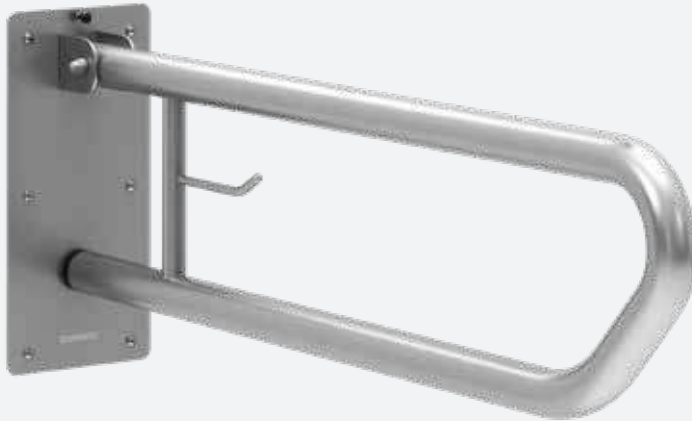

Acero inoxidable 304 *AISI 304 stainless steel*
Satinado *Brushed*

Largo <i>Long</i>	Ref.
800 mm	Ref. GW11 07 04 01
600 mm	Ref. GW11 08 04 01
850 mm	Ref. GW11 73 04 01

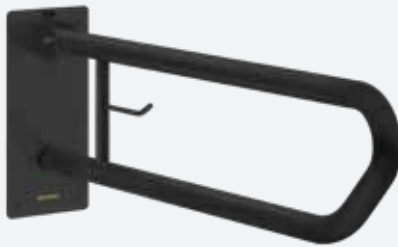

NEW

Acero inoxidable 201 *AISI 201 stainless steel*
Negro mate *Matt black*

Largo <i>Long</i>	Ref.
800 mm	Ref. GW11 07 04 03

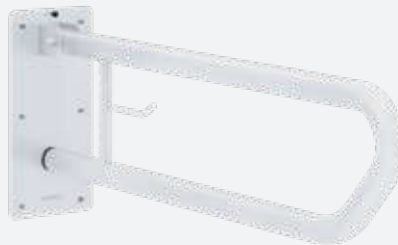

Acero inoxidable 201 *AISI 201 stainless steel*
Epoxi blanco *White epoxy*

Largo <i>Long</i>	Ref.
800 mm	Ref. GW11 07 03 00
600 mm	Ref. GW11 08 03 00
850 mm	Ref. GW11 73 03 00

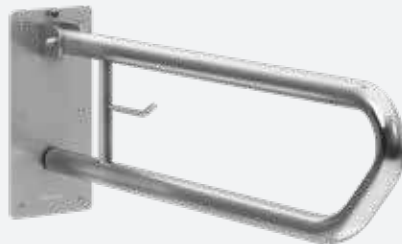

Acero inoxidable 304 *AISI 304 stainless steel*
Brillante *Polished*

Largo <i>Long</i>	Ref.
800 mm	Ref. GW11 07 04 02
600 mm	Ref. GW11 08 04 02

Barra abatible *Folding bar*

Portarollos *w/paper dispenser*

Con sistema de frenado progresivo en todas las barras abatibles *All folding bars include gradual braking system*



NEW

Ref. GW11 27 04 01
 Acero inoxidable 304
AISI 304 stainless steel
 Satinado *Brushed*

Barra abatible desmontable *Removable folding bar*



Ref. GW11 60 04 01
 Acero inoxidable 304
AISI 304 stainless steel
 Satinado *Brushed*

Ref. GW11 60 03 00
 Acero inoxidable 201 *AISI*
201 stainless steel
 Epoxi blanco
White epoxy

Barra abatible con pie a suelo *Folding bar with leg support*

Con sistema de frenado progresivo *All folding bars include gradual*
 en todas las barras abatibles *breaking system*
 Largo 760 mm *Long 760 mm*



Ref. GW11 09 04 01
 Acero inoxidable 304
AISI 304 stainless steel
 Satinado *Brushed*

Ref. GW11 09 03 00
 Acero inoxidable 201
AISI 201 stainless steel
 Epoxi blanco
White epoxy

Ref. GW11 09 04 02
 Acero inoxidable 304
AISI 304 stainless steel
 Brillante *Polished*

Barra abatible con columna de soporte a suelo *Folding bar with floor anchoring column*

Portarollos *w/paper dispenser*
 Con sistema de frenado progresivo *All folding bars include gradual*
 en todas las barras abatibles *braking system*
 Largo 750 mm *Long 750 mm*

Ref. GW11 10 04 01
 Acero inoxidable 304
AISI 304 stainless steel
 Satinado *Brushed*
 Izquierda *Left*

Ref. GW11 11 04 01
 Derecha *Right*



Ref. GW11 10 03 00
 Acero epoxi blanco
White epoxy steel
 Izquierda *Left*

Ref. GW11 11 03 00
 Derecha *Right*

Ref. GW11 10 04 02
 Acero inoxidable 304
AISI 304 stainless steel
 Brillante *Polished*
 Izquierda *Left*

Ref. GW11 11 04 02
 Derecha *Right*

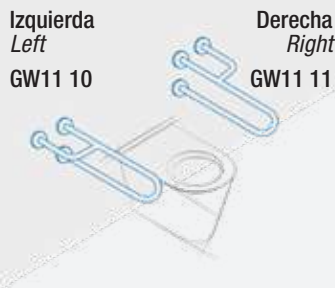

Barra fija 3 anclajes *Grab bar 3 anchorings*

Longitud brazo corto 330 mm *Short arm length 330 mm*
 Longitud brazo largo 600 mm *Long arm length 600 mm*

Ref. GW11 12 03 00
 Acero epoxi blanco
White epoxy steel
 Izquierda *Left*

Ref. GW11 13 03 00
 Derecha *Right*

Ref. GW11 12 04 02
 Acero inoxidable 304
AISI 304 stainless steel
 Brillante *Polished*
 Izquierda *Left*

Ref. GW11 13 04 02
 Derecha *Right*



Ref. GW11 12 04 01
 Acero inoxidable 304
AISI 304 stainless steel
 Satinado *Brushed*
 Izquierda *Left*

Ref. GW11 13 04 01
 Derecha *Right*

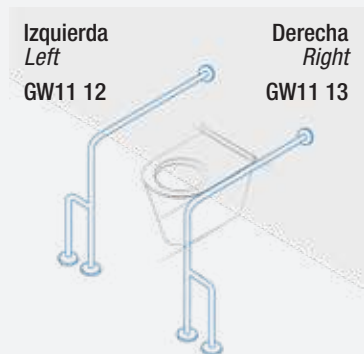

Barra 90° *90° bar*

Altura 840 mm *Height 840 mm*
 Distancia 760 mm *Length 760 mm*

Ref. GW11 14 03 00
Acero epoxi blanco
White epoxy steel

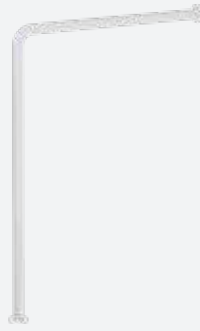

Ref. GW11 14 04 02
Acero inoxidable 304
AISI 304 stainless steel
Brillante *Polished*



Ref. GW11 14 04 01
Acero inoxidable 304
AISI 304 stainless steel
Satinado *Brushed*



Barra 90° 90° bar

Altura 840 mm *Height 840 mm*
Distancia 760 mm *Length 760 mm*

Ref. GW11 22 04 01
Acero inoxidable 304
AISI 304 stainless steel
Satinado *Brushed*

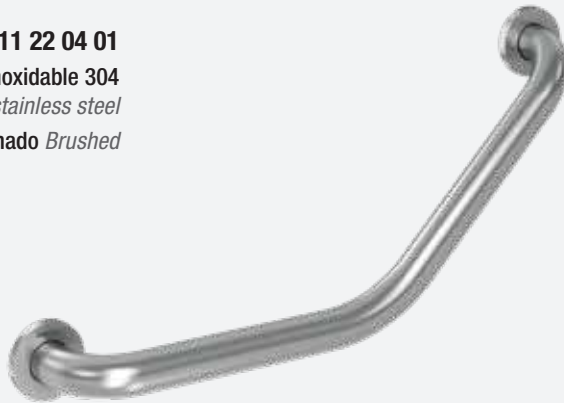

Ref. GW11 22 03 00
Acero epoxi blanco
White epoxy steel



Ref. GW11 22 04 02
Acero inoxidable 304
AISI 304 stainless steel
Brillante *Polished*



Manillón 135° 135° Angled grab bar

Medidas 300 X 300 mm *Measurements 300 X 300 mm*

Ref. GW11 15 04 01
Acero inoxidable 304
AISI 304 stainless steel
Satinado *Brushed*
Izquierda *Left*

Ref. GW11 16 04 01
Derecha *Right*

Ref. GW11 15 03 00
Acero epoxi blanco
White epoxy steel
Izquierda *Left*

Ref. GW11 16 03 00
Derecha *Right*

Ref. GW11 15 04 02
Acero inoxidable 304
AISI 304 stainless steel
Brillante *Polished*
Izquierda *Left*

Ref. GW11 16 04 02
Derecha *Right*



Barra 90° izquierda *90° left side bar*

Barra horizontal 400 mm *Horizontal bar 400 mm*
Barra vertical 800 mm *Vertical bar 800 mm*

Ref. GW11 17 04 01
Acero inoxidable 304
AISI 304 stainless steel
Satinado *Brushed*

Ref. GW11 17 03 00
Acero epoxi blanco
White epoxy steel

Ref. GW11 17 04 02
Acero inoxidable 304
AISI 304 stainless steel
Brillante *Polished*



Barra ángulo pared *Angled wall bar*

Pared 600 x 600 mm *600 x 600 mm wall*
Reversible *Reversible*

Ref. GW11 18 04 01
 Acero inoxidable 304
AISI 304 stainless steel
 Satinado *Brushed*



Ref. GW11 18 03 00
 Acero epoxi blanco
White epoxy steel



Ref. GW11 18 04 02
 Acero inoxidable 304
AISI 304 stainless steel
 Brillante *Polished*

Barra ángulo pared *Angled wall bar*

Pared 700 x 700 mm *700 x 700 mm wall*

Ref. GW11 20 03 00
 Acero epoxi blanco
White epoxy steel
 Izquierda *Left*



Ref. GW11 21 03 00
 Derecha *Right*

Ref. GW11 20 04 02
 Acero inoxidable 304
AISI 304 stainless steel
 Brillante *Polished*
 Izquierda *Left*



Ref. GW11 21 04 02
 Derecha *Right*

Ref. GW11 20 04 01
 Acero inoxidable 304
AISI 304 stainless steel
 Satinado *Brushed*
 Izquierda *Left*

A

Ref. GW11 21 04
 Derecha *Right*

B

C



Izquierda
Left
 GW11 20



Derecha
Right
 GW11 21



Barra 3 lados *3 sided angled*

A - 760 mm A - 760 mm
 B - 460 mm B - 460 mm
 C - 610 mm C - 610 mm



Ref. GW11 10 01 01
Satinado *Brushed*



Ref. GW11 10 01 02
Brillante *Polished*

Soporte Ducha ABS cromado
Shower holder ABS chrome



Ref. GW11 01 90 00
Para barras rectas *For straight bars*

Ref. GW11 01 90 01
Para barras abatibles *For folding bars*

Ref. GW11 01 90 03
Para barra abatible con pie a suelo
For folding bars with leg support

Ref. GW11 01 90 02
Para asientos abatibles
For folding seats



Kit anticonductivo Isolation kit

Ref. GW11 23 04 01
Acero inoxidable 304
AISI 304 stainless steel
Satinado *Brushed*



Ref. GW11 23 03 00
Acero inoxidable 201
AISI 201 stainless steel
Epoxi blanco
White epoxy



Ref. GW11 23 11 00
Acero inoxidable 304
AISI 304 stainless steel
Fenólico *Phenolic*

Asiento abatible *Folding seat*

Con soporte a pared *With wall support*
Con sistema de frenado progresivo en todos los asientos de ducha
All shower seats include gradual braking system
Medidas 200 x 520 x 450 mm *Measurements 200 x 520 x 450 mm*

Ref. GW11 24 04 01
Acero inoxidable 304
AISI 304 stainless steel
Satinado *Brushed*



Ref. GW11 24 03 00
Acero inoxidable 201
AISI 201 stainless steel
Epoxi blanco
White epoxy



Ref. GW11 24 11 00
Acero inoxidable 304
AISI 304 stainless steel
Fenólico *Phenolic*

Asiento abatible con pata *Folding seat with leg*

Con sistema de frenado progresivo en todos los asientos de ducha *With wall support All shower seats include gradual braking system*
Medidas 820 x 520 x 450 mm *Measurements 820 x 520 x 450 mm*

NEW
Ref. GW11 28 01 00
Blanco
White



NEW
Ref. GW11 28 01 03
Negro
Black

Asiento abatible para ducha *Shower compact folding seat*

Con frenado progresivo *With gradual breaking system*



Nylon

Largo <i>Long</i>	Ref.
450 mm	GW11 26 09 00
600 mm	GW11 27 09 00
750 mm	GW11 28 09 00
1.000 mm	GW11 29 09 00

Barra recta *Grab bar*

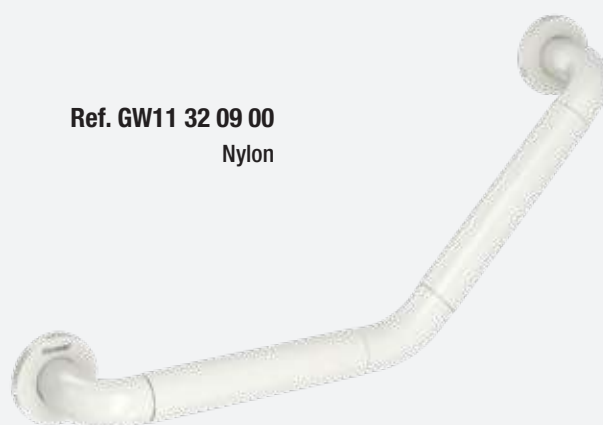

Ref. GW11 32 09 00
Nylon

Manillón de 130° *130° angle grab bar*

Medidas 300 x 300 mm *Measurements 300 x 300 mm*

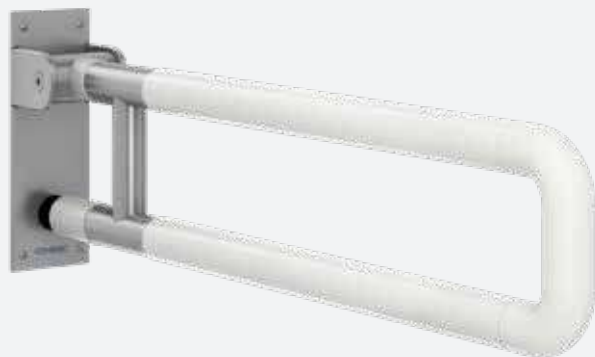

Ref. GW11 30 09 00
Nylon

Barra abatible *Grab bar*

Medidas 700 mm *Measurements 700 mm*



Ref. GW11 31 09 00
Nylon

Barra abatible con pata *Bar with leg support*

Medidas 720 mm *Measurements 720 mm*



Izquierda
Left
GW11 34

Derecha
Right
GW11 33

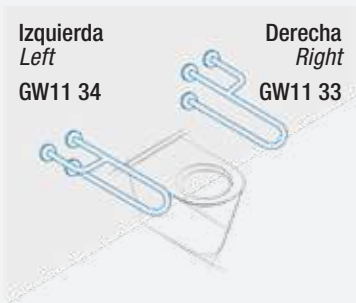

Ref. GW11 34 09 00

Nylon

Izquierda Left

Ref. GW11 33 09 00

Derecha Right

Barra fija 3 anclajes Barra fija 3 anclajes

Medidas 700 mm Measurements 700 mm



Ref. GW11 62 09 00

Nylon

Barra de 90° 90° angled grab bar

Medidas 600 x 400 mm Measurements 600 x 400 mm

Barra horizontal 400 mm Horizontal bar 400 mm

Barra vertical 600 mm Vertical bar 600 mm



Ref. GW11 35 09 00

Nylon

Barra de ducha a pared Wall to wall shower bar

Medidas 600 mm Measurements 600 mm

L1 - 375 mm L1 - 375 mm

L2 - 438 mm L2 - 438 mm

L3 - 800 mm L3 - 800 mm

L4 - 900 mm L4 - 900 mm



Ref. GW11 36 09 00

Nylon

Barra pared-pared Wall to wall angled bar

Medidas 815 x 815 mm Measurements 815 x 815 mm

Ref. GW11 38 09 00
Nylon



Asiento abatible para ducha *Folding shower seat*

Medidas 480 x 320 mm *Measurements 480 x 320 mm*

Ref. GW11 39 09 00
Nylon



Asiento de ducha abatible con pata
Folding shower seat with leg

Medidas 405 x 320 mm *Measurements 405 x 320 mm*



Ref. GW11 61 09 00
Nylon

Asiento ducha para enganchar a barra
Shower seat to hang on grab bar

Medidas 320 X 390 x 490 mm *Measurements 320 X 390 x 490 mm*

Ref. GW11 40 09 00
Nylon



Asiento para ducha *Shower seat*

Medidas 500 X 500 x 350 mm *Measurements 500 X 500 x 350 mm*

Ref. GW11 37 09 00
Nylon



Toallero *Towel bar*

Medidas 500 mm *Measurements 500 mm*



Ref. GW11 66 02 00
Con marco de aluminio
pintado en blanco
*With white painted
aluminium frame*
Medidas *Measurements*
600 x 450 mm

Espejo basculante *Mirror tilting*



Ref. GW11 41 09 00
Nylon
Medidas *Measurements*
500 X 500 mm

Espejo retráctil *Mirror retractable*

Espejo *Mirror*

Ref. GW11 69 04 01
Con marco de acero inoxidable 304
With AISI 304 stainless steel frame
Medidas *Measurements* 700 x 500 mm

Ref. GW11 70 04 01
Medidas *Measurements* 800 x 600 mm



Kit para reclinar espejo *Tilting kit for mirror*

Ref. GW11 71 04 01
Para *For* GW11 69
Medidas *Measurements*
50 x 494 x 80 mm

Ref. GW11 72 04 01
Para *For* GW11 70
Medidas *Measurements*
50 x 594 x 80 mm

Ref. GW11 49 07 00
 Porcelana
Chinese porcelain



Lavabo ergonómico *Ergonomic washbasin*

Medidas 150 X 650 x 570 mm *Measurements 150 X 650 x 570 mm*

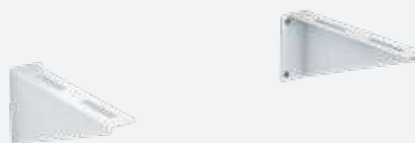

Ref. GW11 50 03 00
 Fija *Fixed*
 Medidas *Measurements*
 140 X 555 x 360 mm



Ref. GW11 51 03 00
 Con inclinación manual
Manual reclining mechanism
 Medidas *Measurements*
 145 X 574 x 385 mm



Ref. GW11 52 03 00
 Con mando neumático
Pneumatic reclining mechanism
 Medidas *Measurements*
 145 X 574 x 385 mm

Ménsulas para lavabo cerámico
Bracket for washbasin



Ref. GW11 54 06 02

Grifo monomando mezclador
Medical single-lever mixer

Medidas 207 X 55 x 184 mm *Measurements 207 X 55 x 184 mm*



Ref. GW11 53 01 00

Sifón flexible *Flexible drainage siphon*

Ref. GW11 42 07 00

Porcelana
Chinese porcelain

Salida a suelo
Floor outlet

Ref. GW11 43 07 00

Salida a pared
Wall outlet



WC ergonómico *Ergonomic WC*

Medidas 490 X 380 x 520 mm *Measurements 490 X 380 x 520 mm*



Ref. GW11 44 07 00

Porcelana
Chinese porcelain

Inodoro suspendido *Wall hanging WC*

Medidas 360 X 370 x 550 mm *Measurements 360 X 370 x 550 mm*



Ref. GW11 48 01 00

ABS

Mando neumático de encastre a pared
Recessed pneumatic flush on wall

Incluido kit para instalación de
pulsador en pared
Recessed flushing kit included

Ref. GW11 64 01 00

Mando neumático en cisterna
Pneumatic flush on cistern

Pulsador en parte superior cisterna
Flush push-button on upper part of the tank

Cisterna *Cistern*

Medidas 410 X 400 x 160 mm *Measurements 410 X 400 x 160 mm*

Ref. GW11 77 04 01

Respaldo en espuma de poliuretano blanco
White polyurethane foam backrest
Barra en acero inoxidable AISI 304 satinada
AISI 304 brushed grab bar



Respaldo acolchado *Padded backrest*

Medidas 165 x 560 x 300 mm *Measurements 165 x 560 x 300 mm*



Ref. GW11 47 01 00

Para ref. GW11 42 y GW11 43
For ref. GW11 42 & GW11 43

Ref. GW11 63 01 00

Para ref. GW11 44
For ref. GW11 44

WC ergonómico *Ergonomic WC*

Medidas 25 X 380 x 455 mm *Measurements 25 X 380 x 455 mm*



Ref. GW11 58 12 00

Vitrorresina *fiberglass*

Medidas *Measurements* 800 x 800 mm

Ref. GW11 59 12 00

Medidas *Measurements* 900 x 900 mm

Plato de ducha *Shower pan*



Ref. GW11 65 06 02

ABS 1" 1/4 *ABS 1" 1/4*

Para GW11 58 y GW11 59

For GW11 58 & GW11 59

Sifón de descarga *Built-in drain siphon*

Medidas 490 X 380 x 520 mm *Measurements 490 X 380 x 520 mm*





Baño adaptado *Adapted bathroom*



Ducha con filtro antical *Anti-scale shower head*

Ducha en latón cromado o acero inoxidable 304
Chromed brass or AISI 304 stainless steel shower head

**Flujo de agua *Water flow*
Ducha *Shower***

Flujo automático de 110 l/min. a 2 bar
Automatic drain of 110 l/min. at 2 bar

Lavaojos *Eye wash*

Reductor de flujo automático que suministra 12 l/min.
constantes con presiones de 1 a 9 bars
*Automatic flow-rate reducer to get a constant supply of
12 l/min. under pressures from 1 to 9 bars*

Aeradores de latón cromado
Aerators made of chromed brass



Recogedor del lavaojos hecho en
ABS o acero inoxidable
*Eye washer bowl made in ABS or
stainless steel*

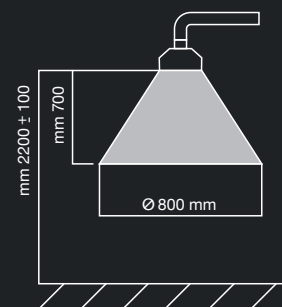



Más sobre la actualidad de lavaojos y duchas de emergencia.
More about current eye washers & emergency showers.

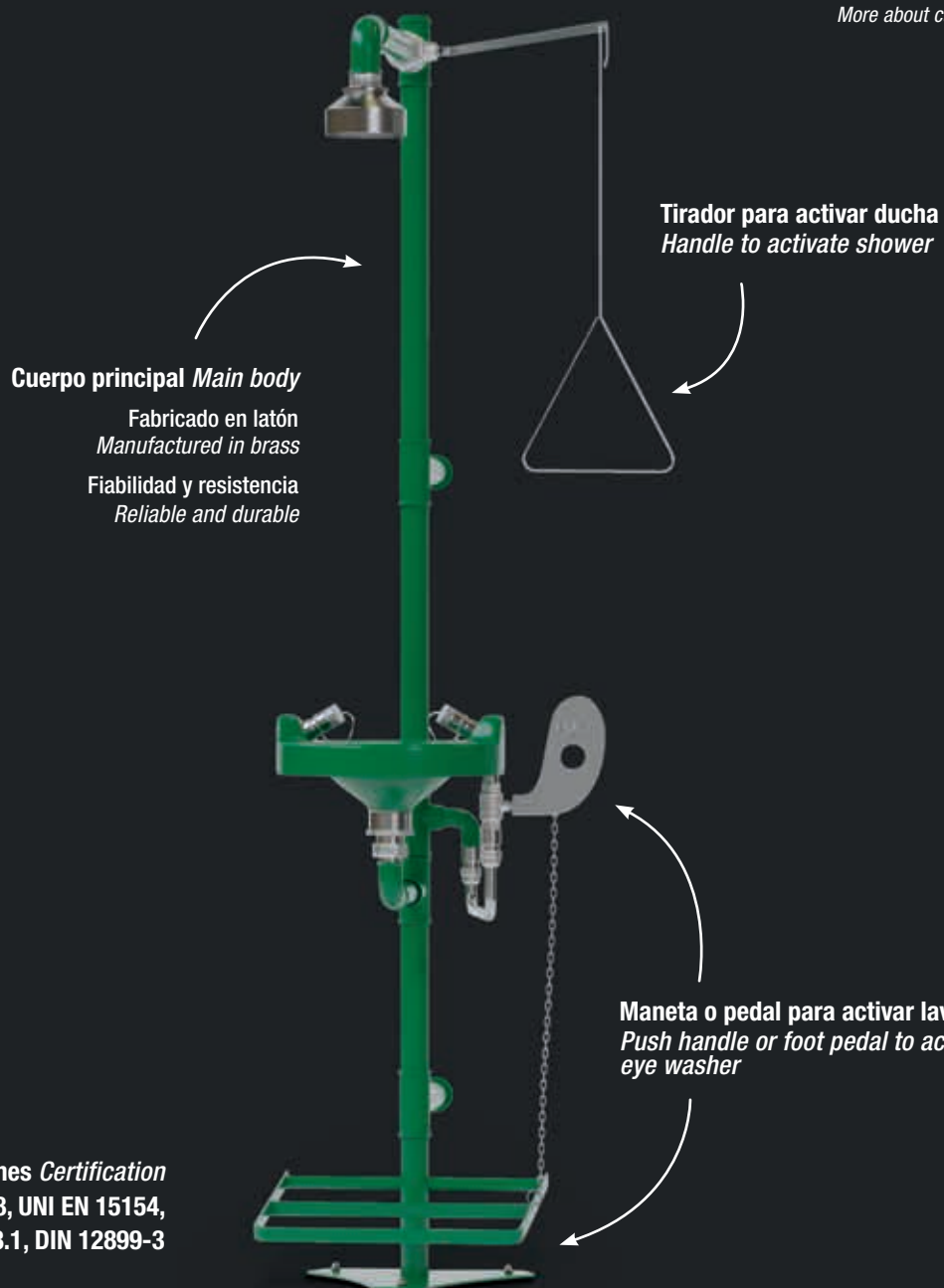

Características destacadas Features

Acero inoxidable
Stainless steel

INOX

Producto anti vandálico
Anti-vandalism product



Funcionamiento manual
Manually operated



Funcionamiento pedal
Pedal operation



Lavaojos
Eyewash



Ducha
Shower



Lavaojos y duchas de emergencia Eye washers & emergency showers



Ref. GW12 01 03 05
 Recogedor en ABS
ABS bowl



Ref. GW12 01 04 05
 Recogedor en acero inoxidable
Stainless steel bowl

Lavaojos mural *Wall mounted eye washer*

Accionamiento mediante palanca lateral
 Lava-ojos en ABS de alta resistencia y metacrilato anti UV
 Reductor automático de caudal para obtener un suministro constante de 12 l/min. con presiones entre 1 y 9 bar

Eyes-washing in high resistance ABS and anti-UV methacrylate
Operated by lateral push lever
Automatic flow-rate reducer to get a constant supply of 12 l/min. under pressures from 1 to 9 bar



Ref. GW12 02 03 05
 Recogedor en ABS
ABS bowl

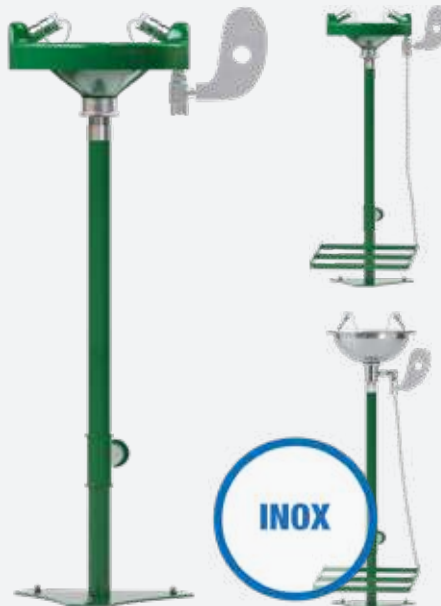

Ref. GW12 03 03 05
 Recogedor en ABS
ABS bowl
 Accionamiento con palanca o pedal
Operated with push lever or pedal



Ref. GW12 02 04 05
 Recogedor en acero inoxidable
Stainless steel bowl

Ref. GW12 03 04 05
 Recogedor en acero inoxidable
Stainless steel bowl
 Accionamiento con palanca o pedal
Operated with push lever or pedal

Lavaojos con pedestal a suelo *Floor standing eye washer*

Accionamiento mediante palanca lateral
 Lava-ojos en ABS de alta resistencia y metacrilato anti UV
 Reductor automático de caudal para obtener un suministro constante de 11 l/min. con presiones entre 1 y 9 bar

Eyes-washing in high resistance ABS and anti-UV methacrylate
Operated by lateral push lever
Automatic flow-rate reducer to get a constant supply of 11 l/min. under pressures from 1 to 9 bar



Ref. GW12 04 03 05

Recogedor en ABS

ABS bowl

Rociador en latón cromado

Chromed brass shower head



INOX



Ref. GW12 04 04 05

Recogedor en acero inoxidable

Stainless steel bowl

Rociador en acero inoxidable

Stainless steel shower head



Ref. GW12 05 03 05



Recogedor en ABS

ABS bowl

Rociador en latón cromado

Chromed brass shower head



INOX

Ref. GW12 05 04 05



Recogedor en acero inoxidable

Stainless steel bowl

Rociador en acero inoxidable

Stainless steel shower head

Combinación de ducha y lavaojos *Shower and eye washer combination*

Accionamiento de ducha mediante tirador triangular

Rociador anti-cal en latón cromado o acero inoxidable

Descarga automática de 110 l/min. a 2 bar

Reductor automático de caudal para obtener un suministro constante de 12 l/min. con presiones entre 1 y 9 bar

Shower operated by triangular handle

Anti-scale shower head in chrome-plated brass or stainless steel

Automatic drain of 110 l/min. at 2 bar

Automatic flow-rate reducer to get a constant supply of 12 l/min. under pressures from 1 to 9 bars





Laboratorio *Laboratory*

Grifería y soluciones integradas

Taps & behind mirror solutions

Cuerpo realizado en latón
Chromed brass body

Ref. GW13 11 06 02 (pág. 179)



Aireador antical con restricción a 8 l/min
Anti-lime aerator with a 8 l/min restriction



Sensor infrarrojo de alta calidad detecta movimientos en un área de hasta 18 cm con un radio de acción de 180°
High-quality IR sensor recognizes movements in a detection area up to 18 cm with a range of 180°

Equipado con conectores estancos y con un grado de protección IP64, protección total contra los ingresos de polvo y salpicaduras de agua
Equipped with watertight connectors and IP64 total protection ingress of dust and splashing water



Más sobre la actualidad de grifería temporizada.
More about current timed taps.



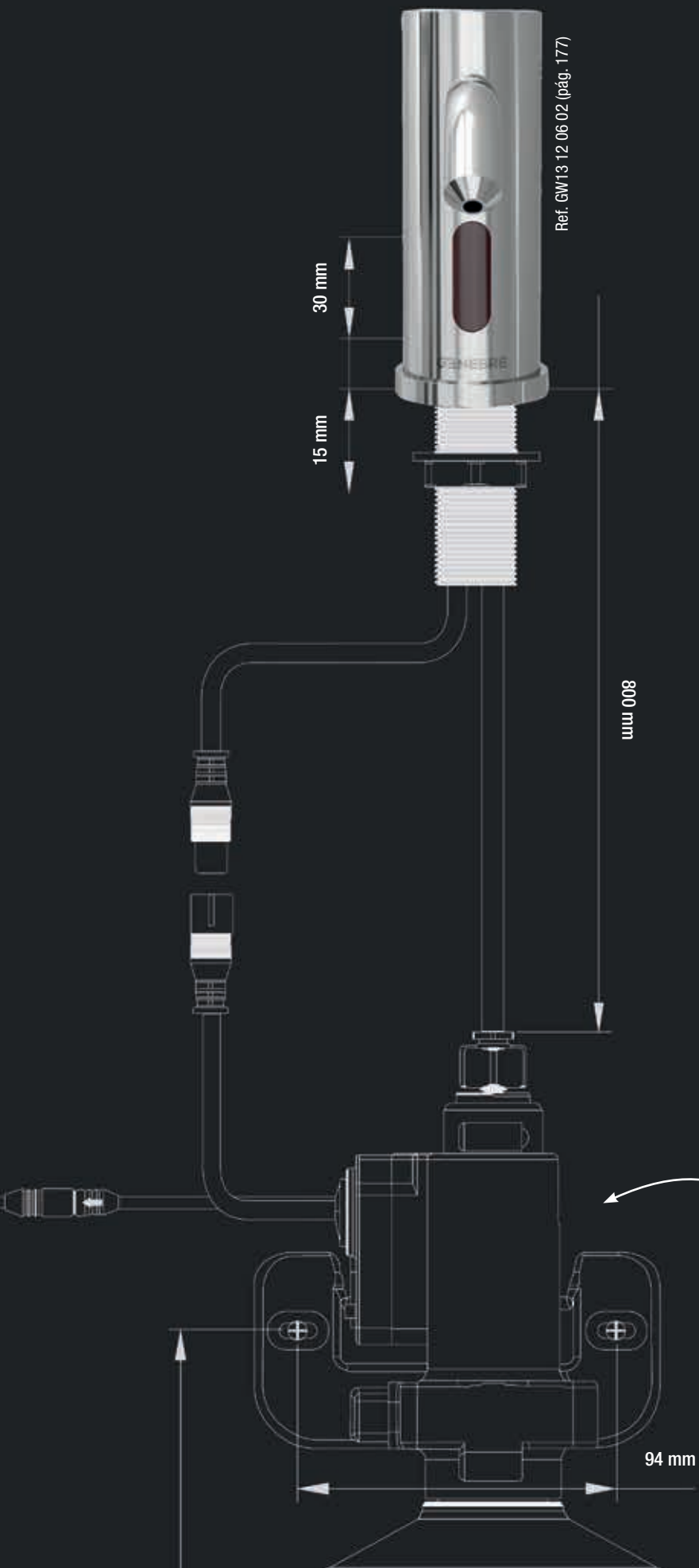

Ref. GW13 12 06 02 (pág. 177)

Funcionamiento mediante baterías (suministradas)
Battery operated (supplied with unit)

Suministrado con latiguillos de 60 cm M10x1 H 3/8", válvulas antirretorno y conjunto de sujeción mediante herradura inoxidable.
Fitted with 60 cm long flexible connectors M10X1 F 3/8", check valves and stainless steel horseshoe fixation set

Cuerpo realizado en latón
Chromed brass body



4 ajustes posibles de dispensación (<2 ml/dosis)
4 dose settings (< 2 ml/dose)

Capacidad botella: 2 l
Bottle capacity: 2 l

Funcionamiento mediante baterías
Battery operated

NEW

Ref. GW13 16 06 02

Latón cromado
Chromed brass

NEW

Ref. GW13 18 06 02

Regula la temperatura añadiendo
la válvula mezcladora

Regulate the temperature
by adding the mixing valve



NEW

Ref. GW13 16 06 03

Latón negro mate
Matt black brass



Grifo lavabo electrónico „Slim“ series *Electronic basin tap „Slim“ series*

Fabricado en latón CW617N

Body manufactured in CW617N brass

Cromado según EN 248

Chromed according to EN 248

Caudal limitado a 3,8 l/min

Limited waterflow to 3.8 l/min

Funcionamiento mediante 2 baterías AAA

Powered by 2 batteries AAA

NEW

Ref. GW13 17 06 02

Latón cromado
Chromed brass



NEW

Ref. GW13 17 06 03

Latón negro mate
Matt black brass



Dosificador jabón electrónico „Slim“ series *Electronic soap dispenser „Slim“ series*

Fabricado en latón CW617N

Body manufactured in brass CW617N

Cromado según EN 248

Chromed as european regulation EN 248

Dosis de dispensación graduable

Adjustable dose settings

Capacidad de 1 l.

1 l. Capacity

Ideal para sitios públicos con alto tráfico

Suitable for high traffic public places

Funcionamiento mediante 4 baterías AAA

Operated with 4 batteries AAA

NEW

Ref. GW13 21 06 02
Latón cromado
Chromed brass



NEW

Ref. GW13 21 06 03
Latón negro mate
Matt black brass

NEW

Ref. GW13 18 06 02
Regula la temperatura añadiendo
la válvula mezcladora
Regulate the temperature
by adding the mixing valve



Grifo lavabo mural electrónico „Slim“ series Wall mounted electronic basin tap „Slim“ series

Fabricado en latón CW617N
Cromado según EN 248
Caudal limitado a 3,8 l/min
Funcionamiento mediante 2 baterías AAA

Body manufactured in CW617N brass
Chromed according to EN 248
Limited waterflow to 3.8 l/min
Powered by 2 batteries AAA

NEW

Ref. GW13 22 06 02
Latón cromado
Chromed brass



NEW

Ref. GW13 22 06 03
Latón negro mate
Matt black brass

Dosificador jabón mural electrónico „Slim“ series Wall mounted electronic soap dispenser „Slim“ series

Fabricado en latón CW617N
Cromado según EN 248
Dosis de dispensación graduable
Capacidad de 1 l.
Ideal para sitios públicos con alto tráfico
Funcionamiento mediante 4 baterías AAA

Body manufactured in CW617N brass
Chromed according to EN 248
Adjustable dose settings
1 l. Capacity
Suitable for high traffic public places
Operated with 4 batteries AAA

NEW
Ref. GW13 18 06 02
Regula la temperatura añadiendo
la válvula mezcladora
*Regulate the temperature
by adding the mixing valve*



Ref. GW13 10 06 02

Grifo lavabo electrónico *Electronic basin mixer tap*

Fabricado en latón HPB 57-3	<i>Body manufactured in brass HPB 57-3</i>
Cromado según EN 248	<i>Chromed as european regulation EN 248</i>
Caudal limitado a 4l/min.	<i>Limited waterflow to 4l/min.</i>
Funcionamiento mediante 2 baterías AAA	<i>Operated with 2 batteries AAA</i>

Ref. GW13 11 06 02



Grifo lavabo electrónico mezclador con batería *Electronic basin mixer tap with battery*

Fabricado en latón CW617N	<i>Body manufactured in brass CW617N</i>
Cromado según EN 248	<i>Chromed as european regulation EN 248</i>
Incluye mezclador	<i>Includes water mixer</i>
Caudal limitado a 8 l/min.	<i>Limited waterflow to 8 l/min.</i>
Detección sensor 18 cm	<i>Sensor detection at 18 cm</i>
Funcionamiento mediante 4 baterías AAA	<i>Operated with 4 batteries AAA</i>



Ref. GW13 12 06 02

Dosificador jabón lavabo encastrado con batería *Electronic undercounter soap dispenser*

Fabricado en latón CW617N	<i>Body manufactured in brass CW617N</i>
Cromado según EN 248	<i>Chromed as european regulation EN 248</i>
Dosis de dispensación graduable	<i>Adjustable dose settings</i>
Capacidad de 1 l.	<i>1 l. Capacity.</i>
Ideal para sitios públicos con alto tráfico	<i>Suitable for high traffic public places</i>
Funcionamiento mediante 4 baterías AA	<i>Operated with 4 batteries AAA</i>



NEW

Ref. GW13 20 06 02

Grifo para detrás de espejo *Behind mirror electronic tap*



NEW

Ref. GW13 19 06 02

Dosificador de jabón detrás de espejo *Behind mirror soap dispenser*

Dosis de dispensación graduable	<i>Adjustable soap settings</i>
Capacidad de 1 l.	<i>1 l. capacity</i>
Ideal para sitios públicos de alto tráfico	<i>Suitable for high traffic public places</i>
Funcionamiento mediante 4 baterías D	<i>Powered by 4 batteries D</i>



NEW

Ref. GW13 20 04 01

Dosificador automático de jabón detrás de espejo fijo *Behind fixed mirror automatic soap dispenser*

Sistema de guías correderas para instalación en espejo fijo	<i>Sliding guides system for installation behind fixed mirror</i>
Dosis de dispensación graduable	<i>Adjustable soap settings</i>
Capacidad de 1 l.	<i>1 l. capacity</i>
Ideal para sitios públicos de alto tráfico	<i>Suitable for high traffic public places</i>
Funcionamiento mediante conexión DC 6V	<i>Powered by DC 6V power supply</i>



Ref. GW13 01 06 02

Grifo temporizado lavabo encimera *Countertop timed washbasin tap*

Cuerpo y florón realizados en latón según UNE-EN 1982	<i>Body and cover made in brass according to UNE-EN 1982</i>
Cromado según EN 248	<i>Chrome plated according to EN 248</i>
Temporización de 12 a 14 segundos	<i>Timing of 12-14 seconds</i>
Caudal mínimo: 12 l/min (3 bar)	<i>Minimum flow rate: 12l /min (3 bar)</i>

Ref. GW13 03 06 02



Grifo temporizado lavabo mural *Wall mounted timed washbasin tap*

Cuerpo y florón realizados en latón según UNE-EN 1982	<i>Body and cover made in brass according to UNE-EN 1982</i>
Cromado según EN 248	<i>Chrome plated according to EN 248</i>
Temporización de 12 a 14 segundos	<i>Timing of 12-14 seconds</i>
Caudal mínimo: 12 l/min (3 bar)	<i>Minimum flow rate: 12 l/min (3 bar)</i>

Ref. GW13 02 06 02



Grifo temporizado urinal mural *Wall mounted timed urinal tap*

Cuerpo y florón realizados en latón según UNE-EN 1982 *Body and cover made in brass according to UNE-EN 1982*
Cromado según EN 248 *Chrome plated according to EN 248*
Temporización de 5 a 7 segundos *Timing of 5-7 seconds*
Caudal mínimo: 6 l/min (3 bar) *Minimum flow rate: 6 l/min (3 bar)*

Ref. GW13 04 06 02

Urinario *Urinal*

Temporización de 5 a 7 segundos
Timing of 5-7 seconds

Ref. GW13 05 06 02

Ducha *Shower*

Temporización de 25 a 30 segundos
Timing of 25-30 seconds



Grifo temporizado empotrado *Built-in timed tap*

Cuerpo y florón realizados en latón según UNE-EN 1982 *Body and cover made in brass according to UNE-EN 1982*
Cromado según EN 248 *Chrome plated according to EN 248*

Ref. GW13 09 06 02



Rociador para ducha antivandálico con rótula *Anti-vandalism shower sprayer with ball*

Cuerpo y florón realizados en latón según UNE-EN 1982
Cromado según EN 248
Caudal consante: 7 l/min

*Body and cover made in brass according to UNE-EN 1982
Chrome plated according to EN 248
Constant flow rate: 7 l/min*



Ref. GW13 15 06 02

Válvula de ducha empotrada con sensor *Built-in sensor shower valve*

Fabricada en acero inoxidable 304
Fabricada según UNE-EN 15091
Detección por infrarrojos
Cierre automático a los 25 segundos
Sistema regulación de caudal
Alimentada a 220V o 4 baterías AAA

*Manufactured in AISI 304 stainless steel
Manufactured as UNE-EN 15091
Infra-red detection system
Security shut off system after 25 seconds
Flow regulation system
Powered with 220V or 4 AAA batteries*



Ref. GW13 13 06 02

Válvula de urinario con sensor *Automatic urinal valve*

Fabricado según UNE-EN 15091	<i>Manufactured as UNE-EN 15091</i>
Detección por infrarrojos	<i>Infra-red detection system</i>
Cierre automático a los 6 segundos	<i>Security shut off system after 6 seconds</i>
Sistema regulación de caudal	<i>Flow regulation system</i>
Suministrado con 4 baterías AAA	<i>Flow regulation system</i>



Ref. GW13 14 06 02

Válvula de urinario empotrada con sensor *Built-in sensor urinal valve*

Fabricada en acero inoxidable 304	<i>Manufactured in AISI 304 stainless steel</i>
Fabricada según UNE-EN 15091	<i>Manufactured as UNE-EN 15091</i>
Detección por infrarrojos	<i>Infra-red detection system</i>
Cierre automático a los 6 segundos	<i>Security shut off system after 6 seconds</i>
Sistema regulación de caudal	<i>Flow regulation system</i>
Alimentada a 220V o 4 baterías AAA	<i>Powered with 220V or 4 AAA batteries</i>

Ref. GW13 06 06 02

Recto *Straight*

Largo *Long* 15,5 cm

Ref. GW13 07 06 02

Largo *Long* 40 cm



Ref. GW13 08 06 02

Curvo *Curved*

Largo *Long* 15,5 cm



Accesorio para urinario *Urinal connector*

Cuerpo y florón realizados en latón según UNE-EN 1982
Cromado según EN 248

*Body and cover made in brass according to UNE-EN 1982
Chrome plated according to EN 248*

Baño de hotel *Hotel bathroom*







NEW

CONTACT

PRODUCTS

QUALITY & CERTIF

DOWNLOADS

NEWS

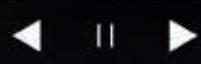

Síguenos / Follow us



GEN WEC COM

IFICATION



Consulta de todas nuestras novedades
Check all our news

Todos los productos Genwec en línea
All Genwec products online

Consulta todas las especificaciones técnicas
Consult all technical specifications

Descarga Manuales e instrucciones
Download Manuals and instructions

Accede al Área de descargas y últimas noticias
Access the downloads and latest news area

Conocer la logística de cada referencia
Know the logistics of each reference

www.genwec.es

Encuentra toda la información de nuestros productos
Find all the information about our products



Contacto con materiales de hierro*
Contact with iron materials*

Lejías y productos con base de hipoclorito*
Chloride containing cleansers*

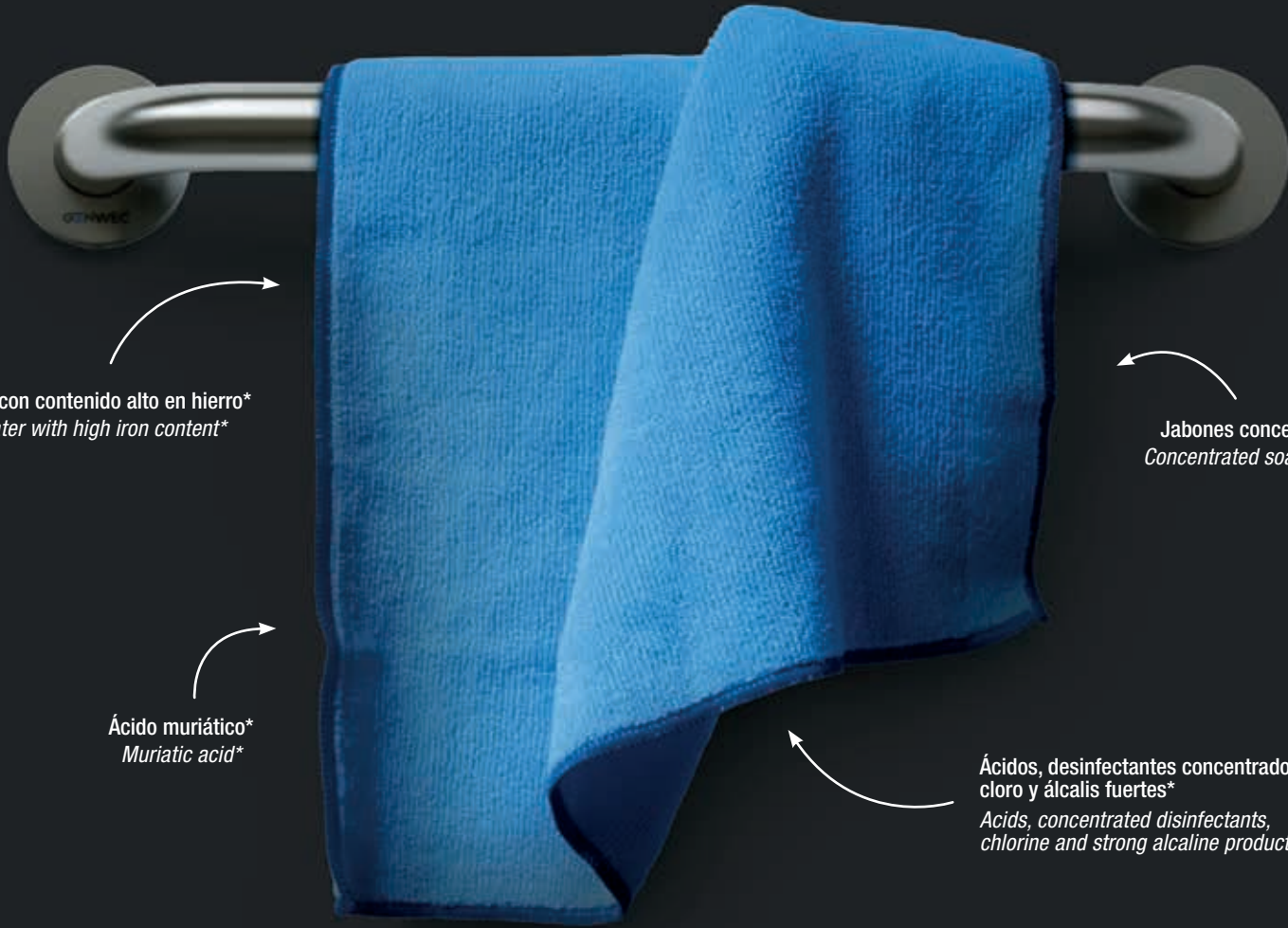

Agua con contenido alto en hierro*
Water with high iron content*

Jabones concentrados*
Concentrated soap residue*

Ácido muriático*
Muriatic acid*

Ácidos, desinfectantes concentrados,
cloro y álcalis fuertes*
Acids, concentrated disinfectants,
chlorine and strong alkaline products*

***Productos a evitar para un óptimo mantenimiento del acero inoxidable**
***Products to avoid for optimal maintenance of stainless steel**

Limpieza y mantenimiento del acero inoxidable *Stainless steel maintenance and cleaning*

El acero inoxidable es un acero bajo en carbono y con un mínimo de contenido del 10% de cromo. El cromo da al acero propiedades únicas en cuanto a anti-corrosión frente a la mayoría de productos químicos.

A pesar de ser muy resistente a la corrosión, el mantenimiento incorrecto del acero inoxidable puede oxidarlo o decolorarlo. Es muy importante una limpieza regular con jabón no agresivo y agua, mediante el uso de un paño de algodón.

Stainless steel is a low carbon steel that contains at least 10% chromium. Chromium gives the steel its unique anti-corrosion properties.

Despite its corrosion resistance, the incorrect maintenance of stainless steel can cause corrosion and discoloration. A frequent cleaning with mild soap and water with a cotton cloth is required.

Los productos que acabarán por corroer al acero inoxidable son los siguientes

The following is a list of products that can eventually cause corrosion or discoloration of stainless steel

Las lejías y productos de limpieza a base de hipoclorito *Chloride containing cleansers: This includes all products which contain a certain amount of bleach*

Ácido muriático *Muriatic acid*

Jabones concentrados *Concentrated soap residue*

Agua con contenido alto en hierro *Water with high iron content*

Contacto con materiales de hierro *Contact with iron materials*

Ácidos, desinfectantes concentrados, cloro y álcalis fuertes (sosa cáustica) *Acids, concentrated disinfectants, chlorine and strong alkaline products*

Muchas decoloraciones del acero inoxidable pueden ser eliminadas mediante el uso de jabones no agresivos o productos especiales para la limpieza del acero inoxidable. Sin embargo, el mantenimiento correcto del acero inoxidable garantiza la apariencia original.

Most discolorations can be removed by using mild soap or products specially designed for stainless steel cleaning. However, the correct maintenance and cleaning, guarantees the original appearance indefinitely.

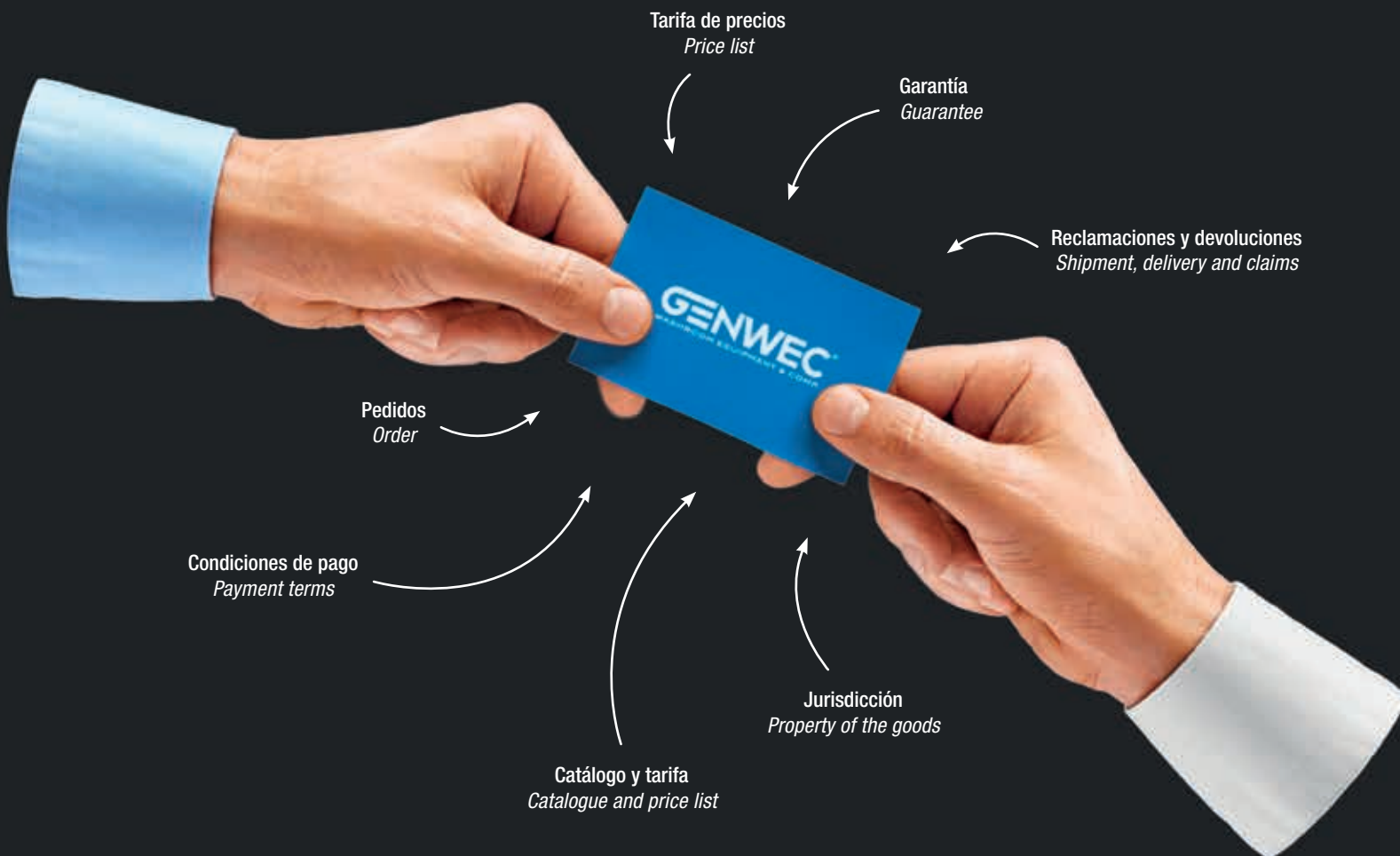

Condiciones generales de venta *General sales conditions*

Condiciones de pago

En aplicación de la Ley 15/2010 que limita los plazos máximos de pago en las operaciones comerciales, hemos ajustado las condiciones a los dispuestos en la misma. En caso de diferirse el pago, los gastos de negociación de efectos y/o los intereses legales especificados serán a cargo del comprador. El impago de cualquier efecto o recibo, conllevará la inmediata suspensión de suministros y servicios.

Payment terms

We have adjusted the conditions in application of Law 15/2010 which limits the maximum terms of payment in commercial transactions. The maximum delay on payment will be 60 days after invoice date. Payment term will be agreed between the parties. In case of unpaid, the expenses and interests incurred will be paid by the purchaser. The unpaid maturity will imply the complete suspension of any service or supply.

Pedidos

Los pedidos deberán formalizarse mediante documento escrito. Cada pedido solicitado será confirmado por Genwec vía email/fax. Salvo notificación de lo contrario en las siguientes 24h, el pedido seguirá su curso sin derecho a posteriores reclamaciones.

Orders

Regarding the handling of any supply, it is compulsory for the purchaser to send a written signed and sealed purchasing order indicating clearly GENWEC's reference, including measurements digits and also the quantity required according to obligated minimum units of purchase (boxes). In case of discrepancies, GENWEC has the right to accept or cancel the pending orders. All the orders will be confirmed by GENWEC by e-mail/fax. Each confirmed order will be handled with no right from the purchaser to modify it, unless previous notification 24 hours after confirmation.

Tarifa de precios

Genwec comunicará a sus clientes cualquier cambio que se produzca en las tarifas a través de alguna de las vías de comunicación usuales (web, email, correo).

Expediciones

Todo pedido superior a 250 euros en Península se suministrará a portes pagados. Para Canarias, Ceuta, Melilla, Baleares y Andorra consultar condiciones.

Reclamaciones y devoluciones

Las eventuales reclamaciones deben efectuarse dentro de los 15 días desde su entrega. No se aceptará ninguna devolución de material sin aprobación previa de nuestro Departamento Comercial que facilitará un número de boletín de devolución que debe acompañar al material devuelto. Todas las devoluciones serán con los portes a cargo del comprador. Y se realizará un cargo por demérito del 10% del valor de la mercancía.

No se aceptará devoluciones de producto personalizado, a medida o fuera de catálogo.

Las devoluciones deberán llevar su embalaje original, sin anotaciones ni etiquetas y con los accesorios de instalación completos.

Garantía

Queda limitada a la legislación vigente. Salvo en aquellos productos que, por cortesía de Genwec; se hayan establecido unos plazos superiores. Para estos casos será necesario haber cumplimentado el formulario que se adjunta en la página web.

Catálogo y tarifa

El catálogo y tarifa entran en vigor el 1 de abril de 2021. Genwec Washroom S.L. por motivos de política de mejora de sus productos, se reserva el derecho a modificar las características, especificaciones y precios en cualquier momento.

Genwec Washroom S.L. pone a su disposición la información técnica actualizada de todos sus productos en su página web www.genwec.com

Jurisdicción

Serán únicamente competentes en caso de litigio, los tribunales de la provincia de Barcelona.

Price list

GENWEC will inform the customers about any change in the price list, through normal communication means (web, e-mail or post).

Product withdrawal from catalogue

GENWEC will inform the customers about any product withdrawal from the catalogue.

Shipment, delivery and claims

Goods are shipped under the purchaser's own risk, even in special cases. Orders will always be shipped in full boxes.

Any claim must be made within 15 days after date of reception of the goods by the purchaser. Claims after such period will not be considered.

No returned will be accepted without the previous approval from our sales department, who will issue a return certificate that must be included in the returned goods. All returned freight will be paid by the purchaser.

Guarantee

It is limited to defective pieces replacement identified by GENWEC Quality department. We will not accept any return after 15 days from the date of reception by the purchaser.

Catalogue and price list

The catalogue and price list come into force on April 1, 2021. GENWEC WASHROOM S. L. for reasons of policy to improve their Products, reserves the right to modify features, specifications and prices at any time. GENWEC WASHROOM S. L. offers updated technical information on all their products on their website www.genwec.com

Property of the goods

GENWEC has the property right of the supplied goods, until the purchaser has totally paid its value. In the meantime, it will be considered as deposit and custody. Goods shall be claimed in case of breach of payment terms.

Baño de hotel *Hotel bathroom*





GENWEC[®]
WASHROOM EQUIPMENT & COMP.

GENWEC[®]
WASHROOM EQUIPMENT & COMP.

Av. Joan Carles I, 46-48
08908 L'Hospitalet de Llobregat, Barcelona (Spain)
T. +34 936 018 040 - F. +34 936 018 041
comercial@genwec.com - export@genwec.com
www.genwec.com

